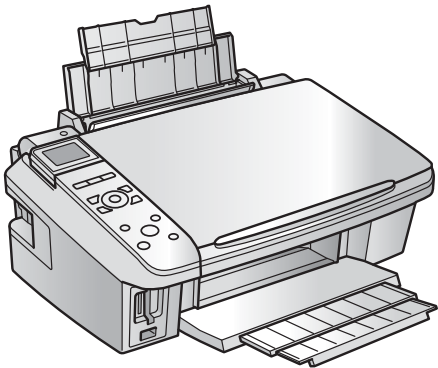
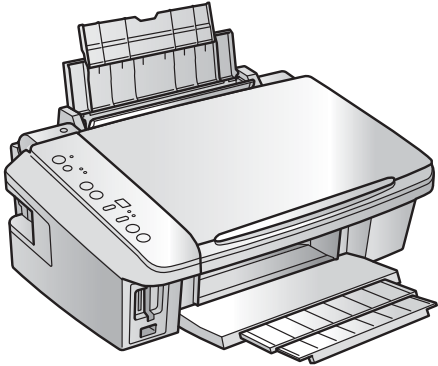


# SERVICE MANUAL



## *Color Inkjet Printer*

**EPSON Stylus CX7300/CX7400/DX7400  
NX200/TX200/TX203/TX209  
SX200/SX205**

**EPSON Stylus CX8300/CX8400/DX8400  
NX400/TX400/TX405/TX409  
SX400/SX405**

## Notice:

- All rights reserved. No part of this manual may be reproduced, stored in a retrieval system, or transmitted in any form or by any means, electronic, mechanical, photocopying, recording, or otherwise, without the prior written permission of SEIKO EPSON CORPORATION.
- The contents of this manual are subject to change without notice.
- All effort have been made to ensure the accuracy of the contents of this manual. However, should any errors be detected, SEIKO EPSON would greatly appreciate being informed of them.
- The above notwithstanding SEIKO EPSON CORPORATION can assume no responsibility for any errors in this manual or the consequences thereof.

EPSON is a registered trademark of SEIKO EPSON CORPORATION.

General Notice: Other product names used herein are for identification purpose only and may be trademarks or registered trademarks of their respective owners. EPSON disclaims any and all rights in those marks.

Copyright © 2008 **SEIKO EPSON CORPORATION.**  
**Imaging Products CS, PL & Environmental Management**

# PRECAUTIONS

Precautionary notations throughout the text are categorized relative to 1) Personal injury and 2) damage to equipment.

***DANGER*** Signals a precaution which, if ignored, could result in serious or fatal personal injury. Great caution should be exercised in performing procedures preceded by DANGER Headings.

***WARNING*** Signals a precaution which, if ignored, could result in damage to equipment.

The precautionary measures itemized below should always be observed when performing repair/maintenance procedures.

## ***DANGER***

1. ALWAYS DISCONNECT THE PRODUCT FROM THE POWER SOURCE AND PERIPHERAL DEVICES PERFORMING ANY MAINTENANCE OR REPAIR PROCEDURES.
2. NO WORK SHOULD BE PERFORMED ON THE UNIT BY PERSONS UNFAMILIAR WITH BASIC SAFETY MEASURES AS DICTATED FOR ALL ELECTRONICS TECHNICIANS IN THEIR LINE OF WORK.
3. WHEN PERFORMING TESTING AS DICTATED WITHIN THIS MANUAL, DO NOT CONNECT THE UNIT TO A POWER SOURCE UNTIL INSTRUCTED TO DO SO. WHEN THE POWER SUPPLY CABLE MUST BE CONNECTED, USE EXTREME CAUTION IN WORKING ON POWER SUPPLY AND OTHER ELECTRONIC COMPONENTS.
4. WHEN DISASSEMBLING OR ASSEMBLING A PRODUCT, MAKE SURE TO WEAR GLOVES TO AVOID INJURIES FROM METAL PARTS WITH SHARP EDGES.

## ***WARNING***

1. REPAIRS ON EPSON PRODUCT SHOULD BE PERFORMED ONLY BY AN EPSON CERTIFIED REPAIR TECHNICIAN.
2. MAKE CERTAIN THAT THE SOURCE VOLTAGES IS THE SAME AS THE RATED VOLTAGE, LISTED ON THE SERIAL NUMBER/RATING PLATE. IF THE EPSON PRODUCT HAS A PRIMARY AC RATING DIFFERENT FROM AVAILABLE POWER SOURCE, DO NOT CONNECT IT TO THE POWER SOURCE.
3. ALWAYS VERIFY THAT THE EPSON PRODUCT HAS BEEN DISCONNECTED FROM THE POWER SOURCE BEFORE REMOVING OR REPLACING PRINTED CIRCUIT BOARDS AND/OR INDIVIDUAL CHIPS.
4. IN ORDER TO PROTECT SENSITIVE MICROPROCESSORS AND CIRCUITRY, USE STATIC DISCHARGE EQUIPMENT, SUCH AS ANTI-STATIC WRIST STRAPS, WHEN ACCESSING INTERNAL COMPONENTS.
5. REPLACE MALFUNCTIONING COMPONENTS ONLY WITH THOSE COMPONENTS BY THE MANUFACTURE; INTRODUCTION OF SECOND-SOURCE ICs OR OTHER NON-APPROVED COMPONENTS MAY DAMAGE THE PRODUCT AND VOID ANY APPLICABLE EPSON WARRANTY.
6. WHEN USING COMPRESSED AIR PRODUCTS; SUCH AS AIR DUSTER, FOR CLEANING DURING REPAIR AND MAINTENANCE, THE USE OF SUCH PRODUCTS CONTAINING FLAMMABLE GAS IS PROHIBITED.

# About This Manual

This manual describes basic functions, theory of electrical and mechanical operations, maintenance and repair procedures of the printer. The instructions and procedures included herein are intended for the experienced repair technicians, and attention should be given to the precautions on the preceding page.

## Manual Configuration

This manual consists of six chapters and Appendix.

### **CHAPTER 1.PRODUCT DESCRIPTIONS**

Provides a general overview and specifications of the product.

### **CHAPTER 2.OPERATING PRINCIPLES**

Describes the theory of electrical and mechanical operations of the product.

### **CHAPTER 3.TROUBLESHOOTING**

Describes the step-by-step procedures for the troubleshooting.

### **CHAPTER 4.DISASSEMBLY / ASSEMBLY**

Describes the step-by-step procedures for disassembling and assembling the product.

### **CHAPTER 5.ADJUSTMENT**

Provides Epson-approved methods for adjustment.

### **CHAPTER 6.MAINTENANCE**

Provides preventive maintenance procedures and the lists of Epson-approved lubricants and adhesives required for servicing the product.

**APPENDIX** Provides the following additional information for reference:

- Exploded Diagram
- Parts List

## Symbols Used in this Manual

Various symbols are used throughout this manual either to provide additional information on a specific topic or to warn of possible danger present during a procedure or an action. Be aware of all symbols when they are used, and always read NOTE, CAUTION, or WARNING messages.



Indicates an operating or maintenance procedure, practice or condition that is necessary to keep the product's quality.



Indicates an operating or maintenance procedure, practice, or condition that, if not strictly observed, could result in damage to, or destruction of, equipment.



May indicate an operating or maintenance procedure, practice or condition that is necessary to accomplish a task efficiently. It may also provide additional information that is related to a specific subject, or comment on the results achieved through a previous action.



Indicates an operating or maintenance procedure, practice or condition that, if not strictly observed, could result in injury or loss of life.



Indicates that a particular task must be carried out according to a certain standard after disassembly and before re-assembly, otherwise the quality of the components in question may be adversely affected.

## Revision Status

Revision	Date of Issue	Description
A	August 9, 2007	First Release
B	May 20, 2008	<p>Revised Contents</p> <p>Descriptions about Epson Stylus TX200/TX203/SX200/SX205/TX400/TX405/SX400/SX405 are added.</p> <ul style="list-style-type: none"> <li><input type="checkbox"/> Chapter 1 <ul style="list-style-type: none"> <li>■ “CHECK POINT” has been added in 1.1 Features (p9).</li> <li>■ Descriptions have been added in 1.1 Features (p9).</li> <li>■ Made changes in Table 1-2 “Product No. of Ink Cartridges” (p10).</li> <li>■ Made changes in Table 1-6 “Supported Paper” (p13).</li> <li>■ Made changes in Table 1-10 “Primary Power Specifications” (p16).</li> <li>■ Made changes in 1.4.3 Durability (p17).</li> <li>■ Made changes in 1.4.5 Safety Approvals (Safety standards/EMI) (p17).</li> <li>■ Made changes in Table 1-13 “Device ID” (p17).</li> <li>■ “CAUTION” has been added in 1.5.2 Memory Card Slots (p18).</li> <li>■ Made changes in Table 1-15 “List of Supported Memory Card” (p18).</li> <li>■ Made changes in Figure 1-11 “Nozzle Check Pattern” (p39).</li> </ul> </li> <li><input type="checkbox"/> Chapter 2 <ul style="list-style-type: none"> <li>■ 2.3 Electrical Circuit Operating Principles has been deleted.</li> </ul> </li> <li><input type="checkbox"/> Chapter 3 <ul style="list-style-type: none"> <li>■ Made changes in 3.1 Overview (p59).</li> <li>■ Made changes in Table 3-12 “Check point for Memory Card error according to each phenomenon” (p77).</li> </ul> </li> <li><input type="checkbox"/> Chapter 4 <ul style="list-style-type: none"> <li>■ “CHECK POINT” has been added in 4.1 Overview (p91).</li> </ul> </li> <li><input type="checkbox"/> Chapter 7 <ul style="list-style-type: none"> <li>■ 7.2 Electrical Circuits has been deleted.</li> </ul> </li> </ul>
C	July 15, 2008	<p>Revised Contents</p> <ul style="list-style-type: none"> <li><input type="checkbox"/> All Chapter</li> </ul> <p>The model name; Epson Stylus NX200/TX209/NX400/TX409 are added.</p>

# Contents

## **Chapter 1 PRODUCT DESCRIPTION**

1.1 Features.....	9
1.2 Printing Specifications.....	10
1.2.1 Basic Specifications.....	10
1.2.2 Ink Cartridge.....	10
1.2.3 Print Mode.....	11
1.2.4 Supported Paper.....	13
1.2.5 Printing Area.....	15
1.3 Scanner Specifications.....	15
1.3.1 Scanning Range.....	15
1.4 General Specifications.....	16
1.4.1 Electrical Specifications.....	16
1.4.2 Environmental Conditions.....	16
1.4.3 Durability.....	17
1.4.4 Acoustic Noise.....	17
1.4.5 Safety Approvals (Safety standards/EMI).....	17
1.5 Interface.....	17
1.5.1 USB Interface.....	17
1.5.2 Memory Card Slots.....	18
1.6 Control Panel.....	19
1.6.1 Operation Buttons & LEDs.....	19
1.6.2 Control Panel Functions in Each Mode.....	21
1.7 Specification for Each Function.....	29
1.7.1 Stand-alone Copy Function.....	29
1.7.2 Memory Card Direct Print Function.....	31
1.7.3 Camera Direct Print Function (USB Direct Print/PictBridge).....	36
1.7.4 Reprint/Restore Photos Function (CX8300/TX400 series only).....	38
1.7.5 Setup Mode.....	39

## **Chapter 2 OPERATING PRINCIPLES**

2.1 Overview.....	42
2.1.1 Printer Mechanism.....	42
2.1.2 Motors & Sensors.....	43
2.1.3 Printhead.....	44
2.1.4 Carriage Mechanism.....	46
2.1.5 Paper Loading/Paper Feed Mechanism.....	47
2.1.6 Ink System Mechanism.....	52
2.1.7 Ink Sequence.....	55
2.2 Scanner Mechanism.....	56
2.2.1 Scanner Carriage Mechanism.....	56

## **Chapter 3 TROUBLESHOOTING**

3.1 Overview.....	59
3.1.1 Specified Tools.....	59
3.1.2 Preliminary Checks.....	59
3.2 Troubleshooting.....	60
3.2.1 Motor and Sensor Troubleshooting.....	60
3.3 Error Indications and Fault Occurrence Causes.....	61
3.3.1 Error Indication Method.....	61
3.3.2 Troubleshooting by Error Message.....	65
3.3.3 Superficial Phenomenon-Based Troubleshooting.....	83

**Chapter 4 DISASSEMBLY/ASSEMBLY**

---

4.1 Overview .....	91
4.1.1 Precautions .....	91
4.1.2 Tools .....	92
4.1.3 Work Completion Check .....	92
4.1.4 Procedural Differences between the Models .....	94
4.2 Disassembly Procedures .....	95
4.3 Removing the Housing .....	96
4.3.1 Paper Support Assy .....	96
4.3.2 Stacker Assy .....	96
4.3.3 Document Cover/ASF Cover .....	97
4.3.4 Scanner Unit/Hinge .....	98
4.3.5 Upper Housing/Card Slot Cover .....	100
4.4 Removing the Circuit Boards .....	101
4.4.1 Main Board Unit .....	101
4.4.2 Panel Unit/LCD Unit .....	103
4.4.3 Power Supply Unit .....	105
4.5 Disassembling the Printer Mechanism .....	107
4.5.1 Printhead .....	107
4.5.2 CR Scale .....	109
4.5.3 Hopper .....	110
4.5.4 Removing the Printer Mechanism (Lower Housing) .....	111
4.5.5 Left Frame .....	113
4.5.6 Front Frame/Right Frame .....	114
4.5.7 Star Wheel Holder Assy .....	116
4.5.8 EJ Roller .....	116
4.5.9 PF Encoder Sensor .....	117
4.5.10 PF Scale .....	118
4.5.11 PF Motor .....	119
4.5.12 CR Motor .....	120
4.5.13 Main Frame Assy .....	122
4.5.14 CR Unit .....	124
4.5.15 Upper Paper Guide .....	126
4.5.16 ASF Unit .....	126
4.5.17 Ink System Unit .....	128
4.5.18 Front Paper Guide .....	131
4.5.19 PF Roller .....	132
4.5.20 Waste Ink Pads .....	133

4.6 Disassembling the Scanner Unit .....	134
4.6.1 Upper/Front Scanner Housing .....	134
4.6.2 Scanner Carriage Unit .....	135
4.6.3 Scanner Motor Unit .....	138
4.7 Differences in Disassembling/Reassembling Stylus CX7300/TX200 series ....	139
4.7.1 Panel Unit (CX7300/TX200 series) .....	139

**Chapter 5 ADJUSTMENT**

---

5.1 Adjustment Items and Overview .....	142
5.1.1 Servicing Adjustment Item List .....	142
5.1.2 Required Adjustments .....	144
5.2 Using the Adjustment Program .....	146
5.2.1 TOP Margin Adjustment .....	146
5.2.2 First Dot Position Adjustment .....	146
5.2.3 Head Angular Adjustment .....	147
5.2.4 Bi-D Adjustment .....	148
5.2.5 PF Adjustment .....	148
5.2.6 PF Band Adjustment .....	150
5.2.7 Bottom Margin Adjustment .....	150

**Chapter 6 MAINTENANCE**

---

6.1 Overview .....	152
6.1.1 Cleaning .....	152
6.1.2 Service Maintenance .....	152
6.1.3 Lubrication .....	153

**Chapter 7 APPENDIX**

---

7.1 Exploded Diagram / Parts List .....	159
---	-----

CHAPTER

1

**PRODUCT DESCRIPTION**



## 1.1 Features



In this chapter, the product names are called as follows:

Notation	Product name
CX7300 series	Stylus CX7300/CX7400/DX7400
TX200 series	Stylus NX200/TX200/TX203/TX209/SX200/SX205
CX8300 series	Stylus CX8300/CX8400/DX8400
TX400 series	Stylus NX400/TX400/TX405/TX409/SX400/SX405

EPSON Stylus CX7300/TX200/CX8300/TX400 series are color ink-jet printers with scanner function and have the following features.

The difference in appearance between the two models is LCD; CX8300/TX400 series is equipped with LCD, and CX7300/TX200 series is not equipped with it.

### Available Functions

- Printer  
Printing from a computer or directly printing from a memory card.
- Scanner  
Scanning from a computer
- Copy  
Stand alone copy using the scanning and printing functions
- Memory card slot  
Available as USB memory card slot for PC
- Color LCD (CX8300/TX400 series only)
  - 2.5-inch color TFD LCD (CX8300 series)
  - 2.5-inch color  $\alpha$ -TFT LCD (TX400 series)

### High speed & High quality

- Maximum print resolution: SMGA 5760 (H) x 1440 (V) dpi
- D4-chips Turbo II Printhead achieves higher print speed than ever. (Black: 90 nozzles x 1, Color: 90 nozzles x 1 per color)
- Four independent ink cartridges is installed.
- Newly developed pigment ink is employed.
- Borderless printing on specified EPSON brand paper is available.

### Dimensions

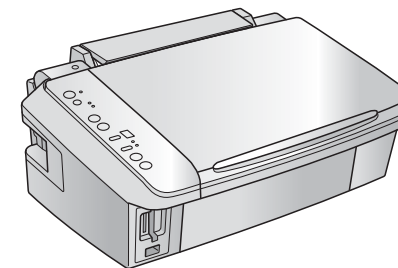
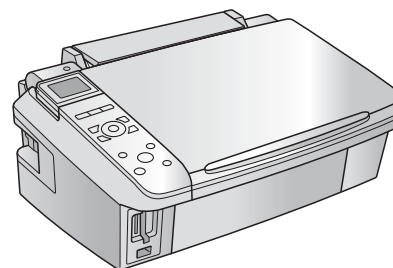
- Stylus CX7300/CX8300 series
  - Dimensions\*1: 450 mm (W) x 340 mm (D) x 179 mm (H)
  - Weight\*2: CX8300 series: 5.9 kg  
CX7300 series: 5.8 kg
- Stylus TX200/TX400 series
  - Dimensions\*1: 450 mm (W) x 342 mm (D) x 182 mm (H)
  - Weight\*2: TX400 series: 5.9 kg  
TX200 series: 5.8 kg

\*1: Paper support and stacker are closed. Rubber feet are excluded.

\*2: Excluding the weight of ink cartridges and power cable.

CX8300/TX400 series

CX7300/TX200 series



Paper Support & Stacker are Closed

CX8300/TX400 series

CX7300/TX200 series

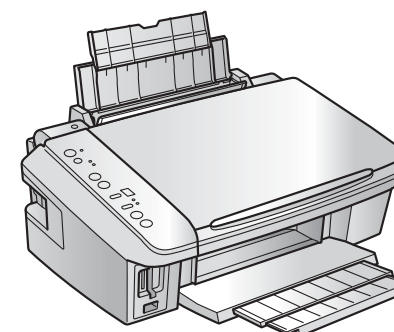
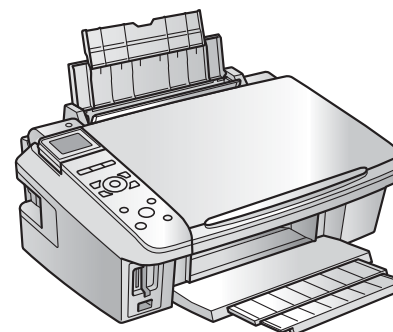


Figure 1-1. External View

## 1.2 Printing Specifications

### 1.2.1 Basic Specifications

Table 1-1. Printer Specifications

Item	Specification
Print method	On-demand ink jet
Nozzle configuration	Black: 90 nozzles x 1 Color: 90 nozzles x 3 (Cyan, Magenta, Yellow)
Print direction	Bi-directional minimum distance printing, Unidirectional printing
Print resolution	Horizontal x Vertical (dpi) <ul style="list-style-type: none"> <li>• 360 x 120                      • 1440 x 720</li> <li>• 360 x 360                    • 1440 x 1440</li> <li>• 360 x 720                    • SMGA 5760 x 1440 (2880 x 1440)</li> <li>• 720 x 720</li> </ul>
Control code	<ul style="list-style-type: none"> <li>• ESC/P Raster command</li> <li>• ESC/P-R (RGB) command</li> <li>• EPSON Remote command</li> </ul>
Input buffer size	64 Kbytes
Paper feed method	Friction feed, using the ASF (Auto Sheet Feeder)
Paper path	Top feed, front out
Paper feed rates	T.B.D. mm/sec (at 25.4 mm feed)
PF interval	Programmable in 0.01764 mm (1/1440 inch) steps

### 1.2.2 Ink Cartridge

The product numbers of the EPSON ink cartridges for this printer are shown below.

Table 1-2. Product No. of Ink Cartridges

Color	EAI	Latin	Euro	CISMEA	Asia
Black	T0681 (S)*1 T0691 (2S) T0881 (3S)*2 T0881 (3S)*4	T0731H (S) T0731HN (S)*4 T0731 (2S) T0731N (2S)*4 T0901 (3S)*3	T0711H (S) T0711 (2S) T0891 (3S)*4	T0731H (S) T0731HN (S)*4 T0731 (2S) T0731N (2S)*4	T0731HN (S)*4 T0731 (2S) T0731N (2S)*4
Cyan	T0692 (3S) T0692 (3S)*4 T0882 (4S)*2 T0882 (4S)*4	T0732 (3S) T0732N (3S)*4	T0712 (3S) T0712 (3S)*4 T0892 (4S)*4	T0732 (3S) T0732N (3S)*4	T0732 (3S) T0732N (3S)*4
Magenta	T0693 (3S) T0693 (3S)*4 T0883 (4S)*2 T0883 (4S)*4	T0733 (3S) T0733N (3S)*4	T0713 (3S) T0713 (3S)*4 T0893 (4S)*4	T0733 (3S) T0733N (3S)*4	T0733 (3S) T0733N (3S)*4
Yellow	T0694 (3S) T0694 (3S)*4 T0884 (4S)*2 T0884 (4S)*4	T0734 (3S) T0734N (3S)*4	T0714 (3S) T0714 (3S)*4 T0894 (4S)*4	T0734 (3S) T0734N (3S)*4	T0734 (3S) T0734N (3S)*4

Note \*1: Available only with CX8300/TX400 series.

\*2: Available only with CX7300/TX200/TX400 series.

\*3: Available only with CX7300/CX8300 series.

\*4: Available only with TX200/TX400 series.

Shelf life

Two years from production date (if unopened), six months after opening package.

Storage Temperature

Table 1-3. Storage Temperature

Situation	Storage Temperature	Limit
When stored in individual boxes	-20 °C to 40 °C (-4°F to 104°F)	1 month max. at 40 °C (104°F)
When installed in main unit	-20 °C to 40 °C (-4°F to 104°F)	

Dimension

12.7 mm (W) x 68 mm (D) x 47 mm (H)



- Do not use expired ink cartridges.
- The ink in the ink cartridge freezes at -16 °C (3.2 °F). It takes about three hours under 25 °C (77°F) until the ink thaws and becomes usable.

### 1.2.3 Print Mode

Table 1-4. Print Mode (Color)

Media	Print Mode	Resolution (H x V dpi)	Dot Size (cps)	Bi-d	Micro Weave	Border-less
<ul style="list-style-type: none"> <li>• Plain paper</li> <li>• Premium Bright White Paper (EAI)</li> <li>• Premium Bright White Inkjet Paper (others)</li> </ul>	Fast Economy/Economy	360x120	Eco (400cps)	ON	OFF	N/A
	Draft	360x120	Eco (400cps)	ON	OFF	N/A
	Normal	360x360	VSD1 (245cps)	ON	OFF	N/A
	Fine (360)	360x720	VSD2 (285cps)	ON	ON	OK
	Fine (720)	720x720	VSD3 (285cps)	ON	ON	OK
	<ul style="list-style-type: none"> <li>• Ultra Premium Glossy Photo Paper (EAI)</li> <li>• Ultra Glossy Photo Paper (others)</li> </ul>	Photo (1440)	1440x720	VSD3 (285cps)	ON	ON
Photo2 (1440)		1440x1440	VSD3 (285cps)	ON	ON	OK
Photo (5760)		2880x1440	VSD3 (285cps)	ON	ON	OK
<ul style="list-style-type: none"> <li>• Photo Paper Glossy (EAI)</li> <li>• Glossy Photo Paper (others)</li> <li>• Premium Photo Paper Glossy (EAI)</li> <li>• Premium Glossy Photo Paper (others)</li> <li>• Premium Photo Paper Semi-Gloss (EAI)</li> <li>• Premium Semigloss Photo Paper (other)</li> </ul>	Photo Draft	360x720	VSD1 (245cps)	ON	ON	N/A
	Photo (720)	720x720	VSD2 (285cps)	ON	ON	OK
	Photo (1440)	1440x720	VSD3 (285cps)	ON	ON	OK
	Photo2 (1440)	1440x1440	VSD3 (285cps)	ON	ON	OK
	Photo (5760)	2880x1440	VSD3 (285cps)	ON	ON	OK
	<ul style="list-style-type: none"> <li>• Premium Presentation Paper Matte (EAI)</li> <li>• Matte Paper Heavy-weight (others)</li> </ul>	Photo (720)	720x720	VSD2 (285cps)	ON	ON
Photo (1440)		1440x720	VSD3 (285cps)	ON	ON	OK

Table 1-4. Print Mode (Color)

Media	Print Mode	Resolution (H x V dpi)	Dot Size (cps)	Bi-d	Micro Weave	Border-less
<ul style="list-style-type: none"> <li>• Photo Quality Inkjet Paper* (others)</li> </ul>	Photo (720)	720x720	VSD2 (285cps)	ON	ON	N/A
	Photo (1440)	1440x720	VSD3 (285cps)	ON	ON	N/A
Envelope	Normal	360x360	VSD1 (245cps)	OFF	OFF	N/A
	Fine (720)	720x720	VSD3 (285cps)	OFF	ON	N/A

Note\* : Not supported in EAI.

Table 1-5. Print Mode (Monochrome)

Media	Print Mode	Resolution (H x V dpi)	Dot Size (cps)	Bi-d	Micro Weave	Border-less
<ul style="list-style-type: none"> <li>• Plain paper</li> <li>• Premium Bright White Paper (EAI)</li> <li>• Premium Ink Jet Plain papers (others)</li> </ul>	Fast Economy/Economy	360x120	Eco (400cps)	ON	OFF	N/A
	Draft	360x120	Eco (400cps)	ON	OFF	N/A
	Normal	360x360	VSD1 (245cps)	ON	OFF	N/A
	Fine (360)	360x720	VSD2 (285cps)	ON	ON	N/A
	Fine (720)	720x720	VSD3 (285cps)	ON	ON	N/A
<ul style="list-style-type: none"> <li>• Ultra Premium Glossy Photo Paper (EAI)</li> <li>• Ultra Glossy Photo Paper (others)</li> </ul>	Photo (1440)	1440x720	VSD3 (285cps)	ON	ON	OK
	Photo2 (1440)	1440x1440	VSD3 (285cps)	ON	ON	OK
	Photo (5760)	2880x1440	VSD3 (285cps)	ON	ON	OK
<ul style="list-style-type: none"> <li>• Photo Paper Glossy (EAI)</li> <li>• Glossy Photo Paper (others)</li> <li>• Premium Photo Paper Glossy (EAI)</li> <li>• Premium Glossy Photo Paper (others)</li> <li>• Premium Photo Paper Semi-Gloss (EAI)</li> <li>• Premium Semigloss Photo Paper (other)</li> </ul>	Photo Draft	360x720	VSD1 (245cps)	ON	ON	OK
	Photo (720)	720x720	VSD2 (285cps)	ON	ON	OK
	Photo (1440)	1440x720	VSD3 (285cps)	ON	ON	OK
	Photo2 (1440)	1440x1440	VSD3 (285cps)	ON	ON	OK
	Photo (5760)	2880x1440	VSD3 (285cps)	ON	ON	OK
<ul style="list-style-type: none"> <li>• Premium Presentation Paper Matte (EAI)</li> <li>• Matte Paper Heavy-weight (others)</li> </ul>	Photo (720)	720x720	VSD2 (285cps)	ON	ON	OK
	Photo (1440)	1440x720	VSD3 (285cps)	ON	ON	OK

Table 1-5. Print Mode (Monochrome)

Media	Print Mode	Resolution (H x V dpi)	Dot Size (cps)	Bi-d	Micro Weave	Border-less
<ul style="list-style-type: none"> <li>• Photo Quality Inkjet Paper* (others)</li> </ul>	Photo (720)	720x720	VSD2 (285cps)	ON	ON	N/A
	Photo (1440)	1440x720	VSD3 (285cps)	ON	ON	N/A
Envelope	Normal	360x360	VSD1 (320cps)	OFF	OFF	N/A
	Fine (720)	360x720	VSD3 (285cps)	OFF	ON	N/A

Note\* : Not supported in EAI.

## 1.2.4 Supported Paper

The table below lists the paper type and sizes supported by the printer. The supported paper type and sizes vary depending on destinations (between EAI, EUR, and Asia).

**Table 1-6. Supported Paper**

Paper Name	Paper Size		Thickness (mm)	Weight	EAI		EUR		Asia	
					P*1	B*2	P*1	B*2	P*1	B*2
Plain paper	Legal	215.9 x 355.6 mm (8.5"x14")	0.08-0.11	64-90 g/m <sup>2</sup> (17-24 lb.)	Y	-	Y	-	Y	-
	Letter	215.9 x 279.4 mm (8.5"x11")			Y	-	Y	-	Y	-
	A4	210 x 297 mm (8.3"x11.7")			Y	-	Y	-	Y	-
	B5	182 x 257 mm (7.2"x10.1")			-	-	Y	-	Y	-
	A5	148 x 210 mm (5.8"x8.3")			-	-	Y	-	Y	-
	Half Letter	139.7 x 215.9 mm (5.5"x8.5")			Y	-	-	-	-	-
	A6	105 x 148 mm (4.2"x5.8")			Y	-	Y	-	Y	-
	User Defined	89 x 127- 329 x 1117.6 mm (3.56"x 5.08" - 13.16"x44.7")			Y	-	Y	-	Y	-
Premium Inkjet Plain Paper	A4	210 x 297 mm (8.3"x11.7")	0.11	80 g/m <sup>2</sup> (21 lb.)	-	-	Y	-	Y	-
Premium Bright White Paper (EAI) Bright White Inkjet Paper (Euro, Asia)	Letter	215.9 x 279.4 mm (8.5"x11")	0.11	90 g/m <sup>2</sup> (24 lb.)	Y	-	-	-	-	-
	A4	210 x 297 mm (8.3"x11.7")	0.13	92.5 g/m <sup>2</sup> (25 lb.)	-	-	Y	-	Y	-
Ultra Premium Glossy Photo Paper (EAI) Ultra Glossy Photo Paper (Euro, Asia)	Letter	215.9 x 279.4 mm (8.5"x11")	0.30	290 g/m <sup>2</sup> (77 lb.)	Y	Y	-	-	-	-
	A4	210 x 297 mm (8.3"x11.7")			-	-	Y	Y	Y	Y
	8" x 10"	203.2 x 254 mm			Y	Y	-	-	-	-
	5" x 7"	127 x 178 mm			Y	Y	Y	Y	-	-
	4" x 6"	101.6 x 152.4 mm			Y	Y	Y	Y	Y	Y
Premium Photo Paper Glossy (EAI) Premium Glossy Photo Paper (Euro, Asia)	Letter	215.9 x 279.4 mm (8.5"x11")	0.27	255 g/m <sup>2</sup> (68 lb.)	Y	Y	-	-	-	-
	A4	210 x 297 mm (8.3"x11.7")			Y	Y	Y	Y	Y	Y
	8" x 10"	203.2 x 254 mm			Y	Y	-	-	-	-
	5" x 7"	127 x 178 mm			Y	Y	Y	Y	Y	Y
	4" x 6"	101.6 x 152.4 mm			Y	Y	Y	Y	Y	Y
	16:9 wide	101.6 x 180.6 mm			Y	Y	Y	Y	Y	Y

Table 1-6. Supported Paper

Paper Name	Paper Size		Thickness (mm)	Weight	EAI		EUR		Asia	
					P*1	B*2	P*1	B*2	P*1	B*2
Photo Paper Glossy (EAI) Glossy Photo Paper (Euro, Asia)	Letter	215.9 x 279.4 mm (8.5"x11")	0.25	258 g/m <sup>2</sup> (68 lb.)	Y	Y	-	-	-	-
	A4	210 x 297 mm (8.3"x11.7")			Y	Y	Y	Y	Y	Y
	5" x 7"	127 x 178 mm			-	-	Y	Y	-	-
	4" x 6"	101.6 x 152.4 mm			Y	Y	Y	Y	Y	Y
Premium Photo Paper Semi-Gloss (EAI) Premium Semigloss Photo Paper (Euro, Asia)	Letter	215.9 x 279.4 mm (8.5"x11")	0.27	250 g/m <sup>2</sup> (66 lb.)	Y	Y	-	-	-	-
	A4	210 x 297 mm (8.3"x11.7")			-	-	Y	Y	Y	Y
	4" x 6"	101.6 x 152.4 mm			Y	Y	Y	Y	Y	Y
Premium Presentation Paper Matte (EAI) Matte Paper-Heavyweight (Euro, Asia)	Letter	215.9 x 279.4 mm (8.5"x11")	0.23	167 g/m <sup>2</sup> (44 lb.)	Y	Y	-	-	-	-
	A4	210 x 297 mm (8.3"x11.7")			-	-	Y	Y	Y	Y
	8" x 10"	203.2 x 254 mm			Y	Y	-	-	-	-
Photo Quality Inkjet Paper	A4	210 x 297 mm (8.3"x11.7")	0.13	102 g/m <sup>2</sup> (27 lb.)	-	-	Y	-	Y	-
Envelopes	#10	104.8 x 241.3 mm (4.125"x9.5")	-	75-100 g/m <sup>2</sup> (20-27 lb.)	Y	-	Y	-	Y	-
	#DL	110 x 220 mm			-	-	Y	-	Y	-
	#C6	114 x 162 mm			-	-	Y	-	Y	-
Photo Paper*3	A4	210 x 297 mm (8.3"x11.7")	0.24	190 g/m <sup>2</sup> (51 lb.)	-	-	Y	Y	Y	-
	5" x 7"	127 x 178 mm			-	-	Y	Y	-	-
	4" x 6"	101.6 x 152.4 mm			-	-	Y	Y	Y	Y

Note \*1: "Y" in the "P" column stands for "the paper type/size is Supported".

\*2: "Y" in the "B" column stands for "Borderless printing is available".

\*3: CX7300/CX8300 series is not supported.



- Make sure the paper is not wrinkled, fluffed, torn, or folded.
- The curve of paper must be 5 mm or below.
- When printing on an envelope, be sure the flap is folded neatly.
- Do not use the adhesive envelopes.
- Do not use double envelopes and cellophane window envelopes.

## 1.2.5 Printing Area

The printing area for this printer is shown below.

Table 1-7. Printing Area (Margins)

Print Mode	Paper Size	Margin			
		Left	Right	Top	Bottom
Standard print	Any size	3 mm	3 mm	3 mm	3 mm
	Envelope	5 mm	5 mm	3 mm	20 mm
Borderless print	A4/Letter to 5" x 7" / Hi-Vision	2.54 mm*	2.54 mm*	2.96 mm*	3.39 mm*
	4" x 6"			2.82 mm*	3.39 mm*

Note \*: The margins for Borderless print are margins that bleed off the edges of paper.

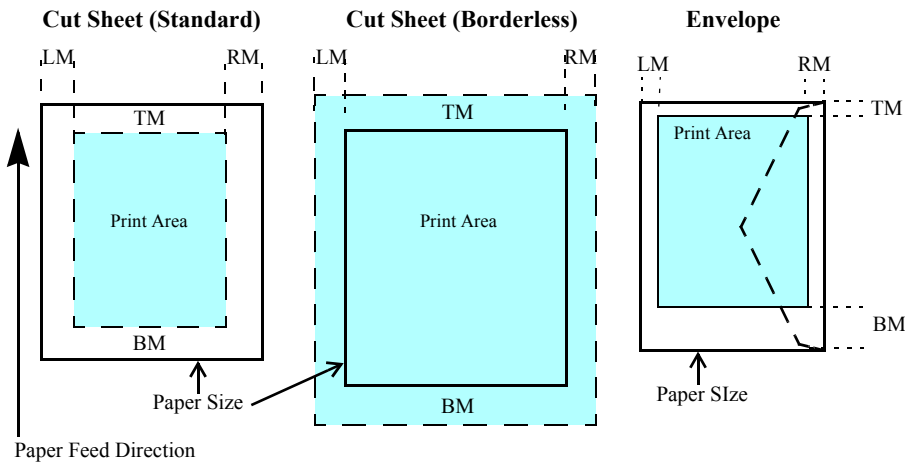


Figure 1-2. Printing Area

## 1.3 Scanner Specifications

Table 1-8. Basic Specifications

Item	Specification
Scanner type	Flatbed, color
Scanning method	Moving carriage, stationary document
Home position	The front right corner
Photoelectric device	CIS
Light source	LED
Maximum document sizes	A4 or US letter
Scanning range	8.5" x 11.7" (216 mm x 297 mm)
Maximum resolution	Main scan: 1200 dpi Sub scan: 2400 dpi
Maximum effective pixels	10,200 x 14,040 pixels (CIS optical resolution x Microstep drive)
Pixel depth	16 bit per pixel (input) and 8 bit per pixel (output).

### 1.3.1 Scanning Range

Table 1-9. Scanning Range

RL (read length)	RW (read width)	OLM (left margin)	OTM (top margin)
216 mm	297 mm	1.5 mm	1.5 mm

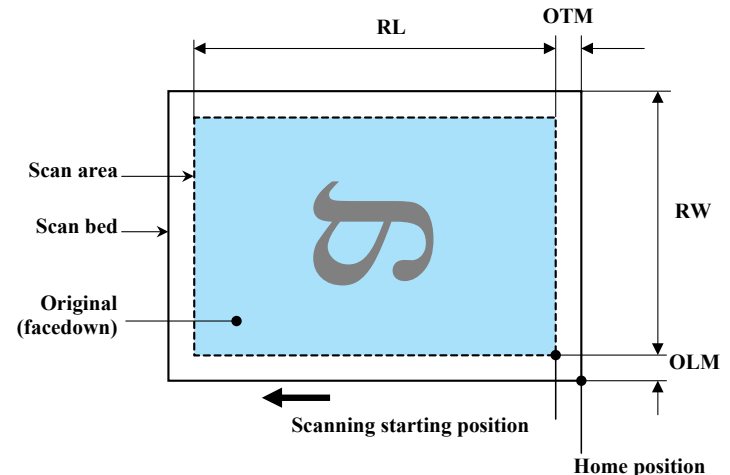


Figure 1-3. Scanning Range

## 1.4 General Specifications

### 1.4.1 Electrical Specifications

Table 1-10. Primary Power Specifications

Item		100-120 V model	220-240 V model
Rated power supply voltage		100 to 120 VAC	220 to 240 VAC
Input voltage range		90 to 132 VAC	198 to 264 VAC
Rated current (Max. rated current)		0.6 A (1.0 A)	0.3 A (0.5 A)
Rated frequency		50 to 60 Hz	
Input frequency range		49.5 to 60.5 Hz	
Insulation resistance		3000 V (for one minute)	
Energy conservation		International Energy Star Program compliant	
Power consumption	Copy (Printing pattern: ISO/IEC24712)	Approx. 12 W	Approx. 12 W
	Ready	Approx. 5.0 W	Approx. 5.0 W
	Sleep	Approx. 2.5 W	Approx. 3 W
	Off	Approx. 0.2W	Approx. 0.3W

- Note 1: If the printer or scanner is not operated for more than three minutes, the printer goes into the power save mode within two minutes.
- 2: When no operation is made with the control panel for more than 13 minutes, the panel goes to the power save mode within two minutes.

### 1.4.2 Environmental Conditions

Table 1-11. Environmental Conditions

Condition	Temperature*1	Humidity*1,2	Shock	Vibration
Operating	10 to 35°C (50 to 95°F)	20 to 80%	1G (1 msec or less)	0.15G, 10 to 55Hz
Storage (unpacked)	-20 to 40°C*3 (-4°F to 104°F)	5 to 85%	2G (2 msec or less)	0.50G, 10 to 55Hz

- Note \*1: The combined Temperature and Humidity conditions must be within the blue-shaded range in Fig.1-4.
- \*2: No condensation
- \*3: Must be less than 1 month at 40°C.

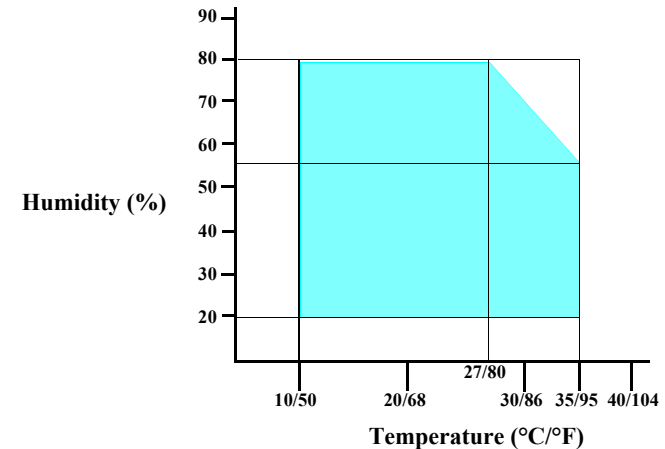


Figure 1-4. Temperature/Humidity Range



- When returning the repaired printer to the customer, make sure the Printhead is covered with the cap and the ink cartridge is installed.
- If the Printhead is not covered with the cap when the printer is off, turn on the printer with the ink cartridge installed, make sure the Printhead is covered with the cap, and then turn the printer off.



### 1.4.3 Durability

- Total print life: Black 10,000 pages (A4, 3.5% duty), Color 10,000 pages (A4, ISO FDC24712), or five years which ever comes first
- Printhead: Five billions shots (per nozzle) or five years which ever comes first
- Scanner carriage: 30,000 cycles of carriage movement

### 1.4.4 Acoustic Noise

- **T.B.D.** dB  
(when printing from PC, on Premium Glossy Photo Paper, in highest quality)
- **T.B.D.** dB (when scanning, default setting)

### 1.4.5 Safety Approvals (Safety standards/EMI)

USA	UL60950-1 FCC Part15 Subpart B Class B
Canada	CSA No.60950-1 CAN/CSA-CEI/IEC CISPR 22 Class B
Mexico	NOM-019-SCFI-1998
Taiwan	CNS13438 Class B CNS14336
EU	EN60950-1 EN55022 Class B EN61000-3-2, EN61000-3-3 EN55024
Germany	EN60950-1
Russia	GOST-R (IEC60950-1, CISPR 22)
Singapore	IEC60950-1
Korea	K60950-1 KN22 Class B KN61000-4-2/-3/-4/-5/-6/-11
China*1	GB4943 GB9254 Class B, GB17625.1
Hong Kong*2	IEC60950-1
Argentina	IEC60950-1
Australia	AS/NZS CISPR22 Class B

Note \*1: CX7300/TX400 series is not supported.

\*2: CX7300 series is not supported.

## 1.5 Interface

This printer has USB interface and memory card slots of the following specifications.

### 1.5.1 USB Interface

The table below describes the specifications of the two USB ports; USB device port for connecting with a host such as a computer, and the USB host port for connecting with an external devices such as a DSC (digital still camera).

**Table 1-12. USB Interface Specifications**

Item	USB Device port	USB Host port*
Compatible standards	<ul style="list-style-type: none"> <li>• Universal Serial Bus Specifications Revision 2.0</li> <li>• Universal Serial Bus Device Class Definition for Printing Devices Version 1.1</li> </ul>	<ul style="list-style-type: none"> <li>• Universal Serial Bus Specifications Revision 2.0</li> <li>• Universal Serial Bus Mass Storage Class Bulk-Only Transport Revision 1.0</li> </ul>
Transfer rate	480 Mbps (High Speed)	12 Mbps (Full Speed)
Data format	NRZI	
Compatible connector	USB Series B	USB Series A
Max. cable length	2 [m] or less	

Note\* : External devices that can be connected to the USB device port are:  
 DSC compliant with the USB Direct Print Protocol specification Rev 1.0  
 DSC compliant with the CIPA DC-001-2003 (PictBridge) specifications

**Table 1-13. Device ID**

When IEEE 1284.4 is Enabled	When IEEE 1284.4 is Disabled
@EJL<SP>ID<CR><LF> MFG:EPSON; CMD:ESCPL2,BDC,D4,D4PX,ESCPRI; MDL: <i>Model Name</i> ; CLS:PRINTER; DES:EPSON<SP> <i>Model Name</i> ;	@EJL<SP>ID<CR><LF> MFG:EPSON; CMD:ESCPL2,BDC;ESCPRI; MDL: <i>Model Name</i> ; CLS:PRINTER; DES:EPSON<SP> <i>Model Name</i> ;

The “*Model Name*” is replaced as shown in the following table.

**Table 1-14. Model Names Indicated in the Device ID**

Destination	North America	Euro	Asia/Pacific
CX7300 series	Stylus CX7400	Stylus DX7400	Stylus CX7300
CX8300 series	Stylus CX8400	Stylus DX8400	Stylus CX8300
TX200 series	TBD	TBD	TBD
TX400 series	TBD	TBD	TBD

## 1.5.2 Memory Card Slots



**In the case of TX200/TX400 series; if you insert a Memory Stick DUO to the Memory Card Slot without using the adapter, make sure to turn off the printer first, then remove the card using tweezers.**

**Table 1-15. List of Supported Memory Card**

Priority	Slot	Compatible memory card	Standard	Max. capacity	Remarks
1	Memory Stick/ Memory Stick PRO	Memory Stick	“MemoryStick Standard” Format Specification Ver.1.42-00 compatible	128MB	Includes versions with memory select function
		MagicGate Memory Stick		128MB	Copy protection function is not supported
		MagicGate Memory Stick Duo			An adapter should be used
		Memory Stick PRO	Memory Stick PRO Format Specifications-without security specifications Ver.1.02-00 compatible	4GB	Copy protection function is not supported
		Memory Stick Duo	MemoryStick Duo Format Specification Ver.1.11-00 compatible		The Memory Stick Duo adapter should be used
		Memory Stick Pro Duo	MemoryStick PRO Duo Format Specification Ver.1.02-00 compatible		The Memory Stick Duo adapter should be used.
		Memory Stick micro	Memory Stick Micro Format Specification Ver.1.02-00 compatible		The Memory Stick adapter for standard size should be used.
	SD/MMC	SD (Security Digital)	SD Memory Card Specifications / PART1. Physical Layer Specification Ver. 2.0 compatible	2GB	
		miniSD/microSD			
		SDHC		8GB	Speed Class is not supported
		miniSDHC/microSDHC			The SD adapter should be used Speed Class is not supported
	MultiMediaCard MultiMediaCard Plus	MultiMediaCard Standard Ver. 4.1 compatible	64MB/4GB	Only MultiMediaCard Plus supports 4GB	
	xD-Picture card	xD-Picture card	xD-Picture Card Specification Ver.1.20 compatible	2GB	Type M/H supported
2	CF Type II	Compact Flash	CF+ and CompactFlash Specification Revision 3.0 compatible (CX7300/CX8300 series)	4GB	True-IDE compatible memory card only
			CF+ and CompactFlash Specification Revision 4.1 compatible (TX200/TX400 series)	32GB	
	Microdrive				

- Note:
- Memory Stick/PRO, SD/MMC and xD-Picture Card shares the same slot.
  - When cards are inserted in the two slots at once, the slot which will be accessed first is determined according to the priority shown in the table.
  - To select a card that has been inserted in a non-active slot, first remove the card in the active slot.
  - In memory card direct printing mode, the image files in the active slot are valid and have assigned frame numbers. The number of images will not change if a card is inserted in another nonselected slot.
  - When the card inserted in the slot is accessed from the PC, only one drive is displayed at a time as a removable disk\* and only the card that is in the active slot can be accessed via the removable disk. A card that has been inserted into a non-selected slot cannot be accessed.  
(This is for Windows. For Macintosh, the card in the active slot will be mounted on the desktop.)
  - Does not support 5V type of memory cards.
  - When a memory card is being accessed, do not touch the memory card.
  - For detailed information on the supported file system and formatting the memory card, refer to “1.7.2 Memory Card Direct Print Function (p. 31)”.

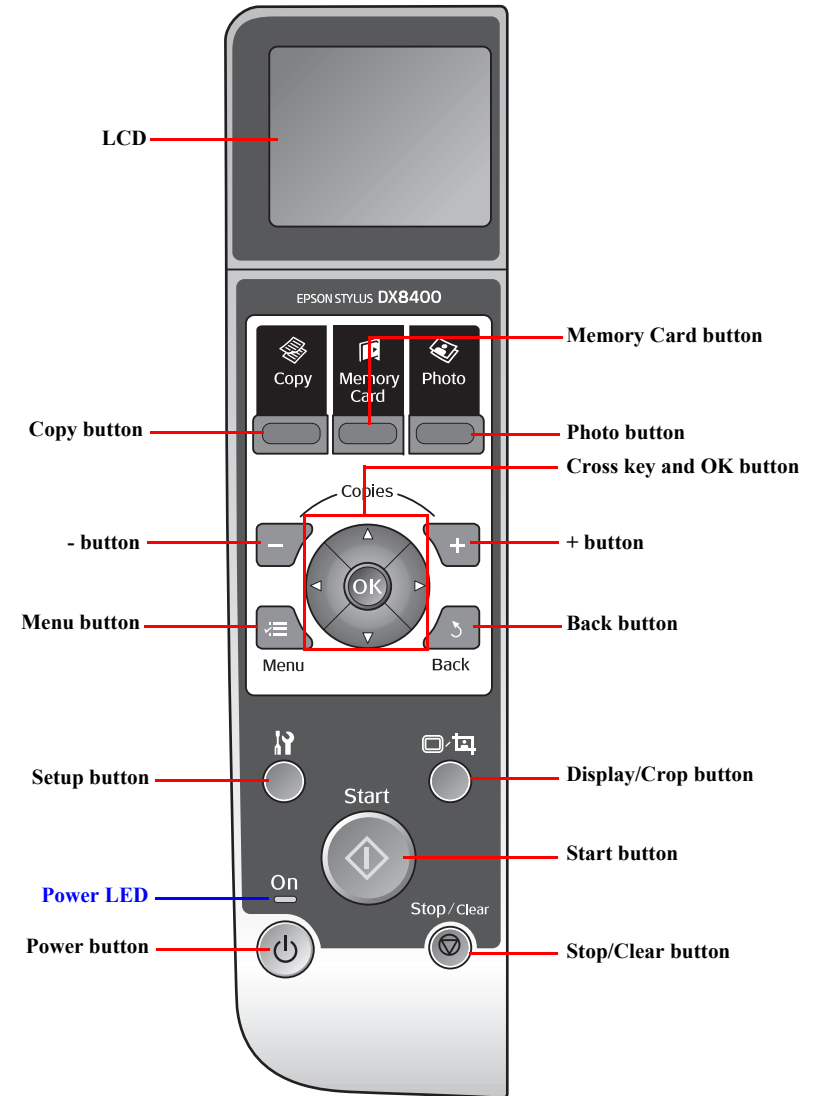
## 1.6 Control Panel

### 1.6.1 Operation Buttons & LEDs

□ CX8300/TX400 series (LCD-equipped model)

Table 1-16. CX8300/TX400 series Buttons & LEDs

Button/LED		Function
Button	Power	Turns the power ON/OFF.
	Start	Starts printing.
	Stop/Clear	<ul style="list-style-type: none"> <li>Stops operation and displays the menu screen.</li> <li>Stops printing and ejects paper.</li> <li>Returns the print settings in the current mode to their default and displays the Top screen. (Returns to the previous screen during printing maintaining the current settings)</li> </ul>
	Setup	Goes to the Setup mode that provides maintenance menu (head cleaning, head alignment, etc.) and various setting menu.
	Display/Crop	<ul style="list-style-type: none"> <li>Goes to the zoom setting screen for the selected image.</li> <li>Changes the image preview layout on the LCD.</li> </ul>
	Menu	Goes to the print setting menu screen.
	OK	Accepts the changed settings
	Back	Cancels the previous operation.
	Cross Key (Up/Down/Left/Right)	Selects a menu item or a setting value.
	+	Sets the number of copies.
	-	
	Copy	Goes to the stand alone Copy mode.
	Memory Card	Goes to the memory card direct print mode.
	Photo	Goes to the special mode that provides Reprint/Restore Photos function.
LED	Power (Green)	<ul style="list-style-type: none"> <li>Flashes at power ON/OFF.</li> <li>Flashes during some sequence is in progress.</li> <li>Flashes when an fatal error occurs.</li> <li>Lights when the status is other than above. (i.e. when in stand-by / in setting operation using the control panel)</li> </ul>
	Card Access (Green)	<ul style="list-style-type: none"> <li>Lights when a memory card is inserted.</li> <li>Flashes when a memory card is being identified or accessed.</li> </ul>



Note : The Card Access LED is provided near the memory card slot.

Figure 1-5. CX8300/TX400 series Control Panel

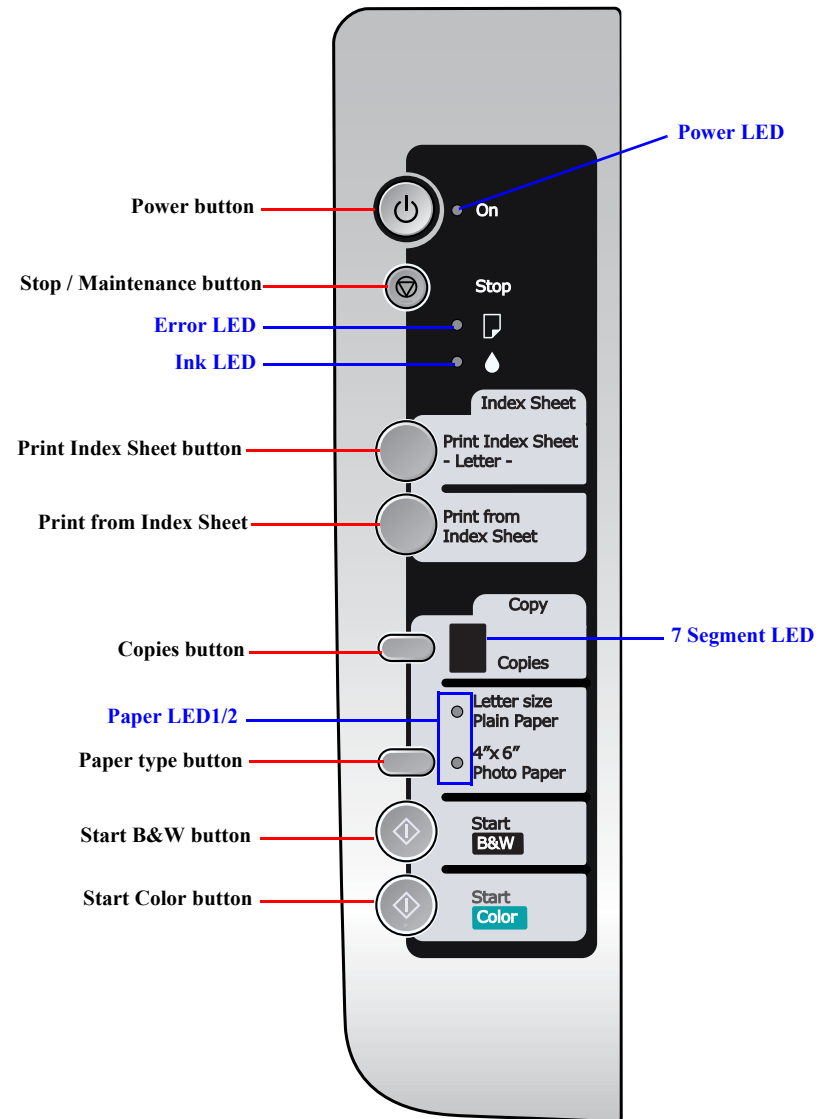
□ CX7300/TX200 series (LCD-non-equipped model)

The printer has the following buttons and LEDs on the control panel.

Table 1-17. CX7300/TX200 series Operation Buttons & LEDs

Button/LED		Function
Button	Power	Turns the power ON/OFF.
	Stop / Maintenance	[When printing] Stops printing, cancels the job, or cancels the error. [When not printing] Performs maintenance such as head cleaning and Ink replacement. Clears the settings.
	Print Index Sheet	Prints an index sheet.
	Print from Index Sheet	Starts reading an index sheet and prints photos stored in memory card.
	Copies	Sets a number of copies.
	Paper Type	Selects paper type and size.
	Start B&W	Starts B&W copying.
	Start Color	Starts color copying.
LED*	Power (Green)	<ul style="list-style-type: none"> <li>Flashes at power ON/OFF.</li> <li>Flashes during some sequence is in progress.</li> <li>Flashes when maintenance is performed or a fatal error occurs.</li> <li>Lights when the printer status is other than above. (standby / while the control panel is used for setting)</li> </ul>
	Error (Orange)	Flashes when a paper- related error occurs.
	Ink (Orange)	Flashes when an ink-related error occurs.
	7 Segments	Displays the number of copies, status, or error code.
	Paper LED 1 (Green)	Lights while plain paper is selected.
	Paper LED 2 (Green)	Lights while photo paper is selected.
	Card Access (Green)	<ul style="list-style-type: none"> <li>Lights while a memory card is inserted in the slot.</li> <li>Flashes while a memory card is accessed.</li> </ul>

Note \*: See Table 1-19 on page 22 and Table 1-20 on page 25 for details on the button functions, and Table 1-21 on page 26 for details on the LED functions.



Note : The Card Access LED is provided near the memory card slot.

Figure 1-6. CX7300/TX200 series Control Panel

## 1.6.2 Control Panel Functions in Each Mode

### 1.6.2.1 Control Panel Functions for CX8300/TX400 series

The table below shows the print setting menu items for each mode and their default, and when the settings are saved or returned to their default. Explanations on detailed control panel functions of the CX8300/TX400 series are omitted here, because the LCD displays the detailed instruction.

**Table 1-18. Timing of Saving or Initializing Control Panel Settings**

Mode	Print Setting	Default Value	Saving Timing	Initializing Timing*
Copy	Copy Type	Color	When the Start button is pressed	When the Stop/Clear button is pressed
	Layout	With Border		
	Number of copies	1		
	Zoom	Actual		
	Paper Type	Plain Paper		
	Paper Size	A4, Letter (for EAI)		
	Quality	Standard		
	Density	±0		
	Expansion	Standard		
Memory Card	Paper Type	Prem. Glossy	When the Start button is pressed	When the Stop/Clear button is pressed
	Paper Size	4x6 inch		
	Layout	Borderless		
	Quality	Standard		
	Expansion	Standard		
	Date	None		
	Bidirectional	On		
	Select (Print Index Sheet setting)	All Photos		
	Information (Print Index Sheet setting) (EAI only)	File Name		
Photo	Paper Type	Prem. Glossy	When the Start button is pressed	When the Stop/Clear button is pressed
	Paper Size	4x6 inch		
	Layout	Borderless		
	Expansion	Standard		
	Color Restoration	Off		
Camera Direct	Paper type	Prem. Glossy	When the settings are made in the PictBridge Setup of the Setup menu.	When the Stop/Clear button is pressed while making the settings.
	Paper size	4x6 inch		
	Layout	Borderless		
	Quality	Standard		
	Expansion	Standard		
	Date	None		
	Bidirectional	On		

Note \*: All the settings except "LCD Brightness" of Setup menu returns to their default when the "Restore Default Settings" of the Setup menu is executed by the OK button.

### 1.6.2.2 Control Panel and LED Functions for CX7300/TX200 series

This section explains the detailed functions of the operation buttons and LEDs of the CX7300/TX200 series that are not equipped with an LCD.

**Table 1-19. CX7300/TX200 series Buttons & LEDs Functions**

Button	Printer Status	Functions			Button Operation Disabled Cases
		During Normal Printing	During DPOF Printing	During Camera Direct Printing	
Power	Normal	<b>Turns the power OFF.</b> <b>(Turns the power ON when the power is OFF.)</b>	Same as the left column.	Same as the left column.	None
	Error				
Stop /Maintenance	Normal	<b>Stops printing and cancels the print/copy job.</b> At this time, the panel settings are not initialized but returned to the previous settings.	Same as the left column.	Same as the left column.	<ul style="list-style-type: none"> <li>• During power ON / OFF operation</li> <li>• During scanner operation from PC</li> <li>• During head cleaning</li> <li>• During ink cartridge replacement</li> </ul>
	Error	<ul style="list-style-type: none"> <li>• Cancels the error, stops printing, cancels the job, or ejects paper.</li> </ul> [When an ink-related error occurs]* <ul style="list-style-type: none"> <li>• Executes an ink cartridge replacement sequence when an ink end error, no ink cartridge error, or ink cartridge error occurs.</li> <li>• Moves the carriage to the ink check position when ink end error or no ink cartridge error occurs.</li> </ul>	Same as the left column.	Same as on the left except the cases below. <ul style="list-style-type: none"> <li>• When a camera direct error (camera recognition is failed) occurs, cancels the error and returns to the status before the error occurs.</li> <li>• When the camera direct error caused by the camera connected before the printer is powered on, returns to stand-by status (initial status at power-on)</li> </ul>	
Stop /Maintenance (when pressed for 3 seconds or more)	Normal	<b>Runs a head cleaning.</b>	Same as the left column.	Same as the left column.	<ul style="list-style-type: none"> <li>• When an ink-out error is occurring</li> <li>• When a no ink cartridge error or ink cartridge error is occurring</li> <li>• When an error other than above or the camera direct error is occurring</li> <li>• During printing</li> <li>• During scanner operation</li> <li>• During head cleaning</li> <li>• During ink cartridge replacement</li> <li>• When printing is being stopped or a print job is being canceled</li> </ul>
	Error	[When a no paper error, memory card error, or index sheet error occurred] Cancels the error and retained print job, and starts head cleaning.	Same as the left column.	<ul style="list-style-type: none"> <li>• Same as the left column in the case of paper-out error.</li> <li>• When a camera direct error (camera recognition is failed) occurs, cancels the error and returns to the status before the error occurs, and then runs a head cleaning.</li> <li>• When the camera direct error caused by the camera connected before the printer is powered on, returns to stand-by status (initial status at power-on), and then runs a head cleaning.</li> </ul>	

Note \* : If the carriage is at an ink check position, the carriage moves to ink check positions for another color in the order of cyan, magenta, yellow, and black (the colors not requiring ink check will be skipped). After ink check is completed, the carriage moves to the ink replacement position. If the carriage is at the ink cartridge replacement position, it moves to the home position.

Continued on next page

Table 1-19. CX7300/TX200 series Buttons & LEDs Functions

Button	Printer Status	Functions			Button Operation Disabled Cases
		During Normal Printing	During DPOF Printing	During Camera Direct Printing	
Print Index Sheet	Normal	<p><b>Starts printing an index sheet.*</b> The paper size / paper type are changed to A4 / plain paper automatically. Initializes the panel settings and turns off the 7-segment LED.</p>	Disabled	Disabled	<ul style="list-style-type: none"> <li>• During printing</li> <li>• During scanner operation</li> <li>• During head cleaning</li> <li>• During ink cartridge replacement</li> <li>• When an error except memory card error, index sheet error is occurring</li> <li>• When print data is spooled</li> <li>• When printing is being stopped or a print job is being canceled</li> <li>• When the button is pressed two or more times after a memory card error occurred.</li> </ul>
	Error	<ul style="list-style-type: none"> <li>• Displays a memory card error when no memory card or a non-supported formatted memory card is detected, or when no image data is found in the memory card.</li> <li>• When an index sheet error is occurring, cancels the error and retries to print the index sheet.</li> <li>• When a paper-out error is occurring, performs paper feed operation. If the paper is fed successfully, cancels the error and prints the index sheet.</li> <li>• When a paper jam error is occurring, performs paper ejection operation. If the paper is ejected successfully, cancels the error and prints the index sheet.</li> </ul>	Disabled	When a camera direct error is occurring, cancels the error and returns to the index sheet print process.	
Print from Index Sheet	Normal	<p><b>Reads an index sheet and starts printing images.</b></p>	Disabled	Disabled	<ul style="list-style-type: none"> <li>• During printing</li> <li>• During scanner operation</li> <li>• During head cleaning</li> <li>• During ink cartridge replacement</li> <li>• When print data is spooled</li> <li>• When printing is being stopped or a print job is being canceled</li> <li>• When the button is pressed two or more times after a memory card error occurred</li> </ul>
	Error	<p>Same as the [Print Index Sheet] button other than the cases below.</p> <ul style="list-style-type: none"> <li>• When the index sheet cannot be read normally, cancels the print job and displays an index sheet error.</li> <li>• When the button is pressed after an index sheet error is displayed, cancels the error display and resumes the print job.</li> </ul>	Disabled	When a camera direct error is occurring, cancels the error and starts reading the index sheet.	
Copies	Normal	<p><b>Sets the number of copies.</b> Default value is 1 copy. 1 to 9 sheets and “≡” (20 sheets continuously) can be set. Saves the set value when starting copying. Does not save when the power is Off. Returns the setting to the default when the power is turned Off or the mode is changed. The 7-segment LED displays the set number of copies and decreases the number each time a copy is made. When the copy job is finished, the number returns to the set value.</p>	<p>Cancels the DPOF mode and returns to standby mode. The set number of copies is returned to the default, and the paper type and size settings are returned to the previous ones.</p>	Disabled	<ul style="list-style-type: none"> <li>• During printing</li> <li>• During scanner operation</li> <li>• During head cleaning</li> <li>• During ink cartridge replacement</li> <li>• When an error is occurring</li> <li>• When print data is spooled</li> <li>• When printing is being stopped or a print job is being canceled</li> </ul>
	Error	Disabled	Disabled	When a camera direct error is occurring, cancels the error, and goes to the standby mode. The set number of copies is returned to the default, and the paper type and size settings are returned to the previous ones.	

Note \*: After printing an index sheet, the paper type and size settings are returned to the previous ones.

Continued on next page

Table 1-19. CX7300/TX200 series Buttons & LEDs Functions

Button	Printer Status	Functions			Button Operation Disabled Cases
		During Normal Printing	During DPOF Printing	During Camera Direct Printing	
<b>Paper Type</b>	Normal	<p><b>Sets the paper size / paper type.</b> Default is A4 (Letter for EAI), Plain Paper Saves the settings when the power is turned Off by the Power button, the modes is changed, or copying is started. Does not save when the power plug is disconnected.</p>	Same as the left column.	Same as the left column.	<ul style="list-style-type: none"> <li>• During printing</li> <li>• During scanner operation</li> <li>• During head cleaning</li> <li>• During ink cartridge replacement</li> <li>• When an error is occurring</li> <li>• When print data is spooled</li> <li>• When printing is being stopped or a print job is being canceled</li> </ul>
	Error	Disabled	Disabled	When a camera direct error is occurring, cancels the error, and goes to the standby mode. The set number of copies is returned to the default, and the paper type and size settings are returned to the previous ones.	
<b>Start B&amp;W</b>	Normal	<p><b>Starts copying in B&amp;W mode.</b> Saves the number of copies and paper type and size settings when starting copying and displays the saved settings after the copying is complete.</p>	Disabled	Disabled*	<ul style="list-style-type: none"> <li>• During printing</li> <li>• During scanner operation</li> <li>• During head cleaning</li> <li>• During ink cartridge replacement</li> <li>• When an ink error is occurring</li> <li>• When print data is spooled</li> <li>• When printing is being stopped or a print job is being canceled</li> </ul>
	Error	<ul style="list-style-type: none"> <li>• When a paper-out error is occurring, performs paper feed operation. If the paper is fed successfully, cancels the error and starts the copy job.</li> <li>• When a paper jam error is occurring, performs paper ejection operation. If the paper is ejected successfully, cancels the error starts the copy job.</li> </ul>	Same as the left column.	Same as the left column.	
<b>Start B&amp;W</b> (when pressed for 3 seconds or more)	Normal	<p><b>Starts autofit copying in B&amp;W mode.</b> Saves the number of copies and paper type and size settings when starting copying and displays the saved settings after the copying is complete.</p>	Disabled	Disabled*	<ul style="list-style-type: none"> <li>• During printing</li> <li>• During scanner operation</li> <li>• During head cleaning</li> <li>• During ink cartridge replacement</li> <li>• When an ink error is occurring</li> <li>• When print data is spooled</li> <li>• When printing is being stopped or a print job is being canceled</li> </ul>
	Error	<ul style="list-style-type: none"> <li>• When a paper-out error is occurring, performs paper feed operation. If the paper is fed successfully, cancels the error and starts the copy job.</li> <li>• When a paper jam error is occurring, performs paper ejection operation. If the paper is ejected successfully, cancels the error starts the copy job.</li> </ul>	Same as the left column.	Same as the left column.	
<b>Stop/Maintenance + Start B&amp;W</b>	Normal	<p><b>Starts monochrome draft copy. (A4 plain paper only)</b> Saves the number of copies and paper type and size settings when starting copying and displays the saved settings after the copying is complete.</p>	Disabled	Disabled*	<ul style="list-style-type: none"> <li>• During scanner operation</li> <li>• During head cleaning</li> <li>• During ink cartridge replacement</li> <li>• When printing is being stopped or a print job is being canceled</li> <li>• When an error is occurring</li> </ul>
	Error	Disabled	Disabled	Disabled	

Note \*: When in camera direct mode, starts printing according to requirements from the camera.

Continued on next page



Table 1-19. CX7300/TX200 series Buttons & LEDs Functions

Button	Printer Status	Functions			Button Operation Disabled Cases
		During Normal Printing	During DPOF Printing	During Camera Direct Printing	
<b>Start Color</b>	Normal	<b>Starts copying in color mode.</b> Saves the number of copies and paper type and size settings when starting copying and displays the saved settings after the copying is complete.	Disabled	Disabled*	<ul style="list-style-type: none"> <li>• During printing</li> <li>• During scanner operation</li> <li>• During head cleaning</li> <li>• During ink cartridge replacement</li> <li>• When an ink error is occurring</li> <li>• When print data is spooled</li> <li>• When printing is being stopped or a print job is being canceled.</li> </ul>
	Error	<ul style="list-style-type: none"> <li>• When a paper-out error is occurring, performs paper feed operation. If the paper is fed successfully, cancels the error and starts the copy job.</li> <li>• When a paper jam error is occurring, performs paper ejection operation. If the paper is ejected successfully, cancels the error starts the copy job.</li> </ul>	Same as the left column.	Same as the left column.	
<b>Start Color</b> (when pressed for 3 seconds or more)	Normal	<b>Starts autofit copying in color mode.</b> Saves the number of copies and paper type and size settings when starting copying and displays the saved settings after the copying is complete.	<b>Starts printing according to the DPOF setting.</b>	Disabled*	
	Error	<ul style="list-style-type: none"> <li>• When a paper-out error is occurring, performs paper feed operation. If the paper is fed successfully, cancels the error and starts the copy job.</li> <li>• When a paper jam error is occurring, performs paper ejection operation. If the paper is ejected successfully, cancels the error starts the copy job.</li> </ul>	Same as the left column.	Same as the left column.	
<b>Stop/Maintenance + Start Color</b>	Normal	<b>Starts color draft copy. (A4 plain paper only)</b> Saves the number of copies and paper type and size settings when starting copying and displays the saved settings after the copying is complete.	Disabled	Disabled*	<ul style="list-style-type: none"> <li>• During scanner operation</li> <li>• During head cleaning</li> <li>• During ink cartridge replacement</li> <li>• When printing is being stopped or a print job is being canceled</li> <li>• When an error is occurring</li> </ul>
	Error	Disabled	Disabled	Disabled	

Note \*: When in camera direct mode, starts printing according to requirements from the camera.

Table 1-20. CX7300/TX200 series Special Button Operations for Maintenance Functions

Button	Function	Remarks
<b>Stop / Maintenance &amp; Power</b> (Power On)	<b>Prints a nozzle check pattern.</b> After printing the pattern, returns to the standby state of normal print mode.	<ul style="list-style-type: none"> <li>• The nozzle check pattern printed by the printer is shown in <a href="#">Figure 1-11</a>.</li> <li>• If the Stop / Maintenance button is pressed while printing a nozzle check pattern, stops printing, eject paper, and turns the power OFF.</li> </ul>
<b>Copies &amp; Power</b> (Power On)	<b>Enters mechanism adjustment mode and prints a Head Alignment pattern.</b> After printing the pattern, goes to the adjustment value input mode.	<ul style="list-style-type: none"> <li>• See “1.7.5.8 Head Alignment (p. 40)” for details on Bi-D adjustment.</li> </ul>

Table 1-21. CX7300/TX200 series LED Functions

Printer Status	LED						Priority
	Power	Error	Ink	7 Segments	Paper 1/2	Card Access	
Power OFF (processing)	High-speed flashing	OFF	OFF	OFF	OFF	--	1
Fatal error (system error)	High-speed flashing	High-speed flashing	High-speed flashing	High-speed flashing of "E"	High-speed flashing (selected side)	--	2
Fatal error (mechanical error)	Flashing	Flashing	Flashing	Flashing of "E"	Flashing (selected side)	--	3
Maintenance request	Flashing	ON	ON	Flashing of "E"	Flashing (selected side)	--	4
Power ON (initializing)	Flashing	--	--	--	--	--	5
Reset request / Stop request / Job cancel request	ON for 1 second	ON for 1 second	ON for 1 second	ON for 1 second	ON for 1 second (selected side)	--	6
Paper jam error	--	Flashing	OFF	--	--	--	7
Ink out error / No ink cartridge error read error / write error	--	OFF	ON	--	--	--	8
Ink cartridge replacement is in progress	Flashing 2	OFF	Flashing 2	--	--	--	9
Ink sequence is in progress	Flashing	--	--	--	--	--	10
No paper error	--	ON	OFF	--	--	--	11
Multi-feed error	---	ON	OFF	--	--	--	11
Index sheet being printed	Flashing*1	--	--	OFF	ON (Paper 1 only)	--	12
Index sheet is being scanned & printed	Flashing*1	--	--	OFF	ON*2 (selected side)	--	12
DPOF printing	Flashing	--	--	ON of "d"	ON (selected side)	--	12
Copying	Flashing	--	--	Displays remaining number of copies*3	ON (selected side)	--	12
Camera direct printing	Flashing	--	--	ON of "P"	ON (selected side)	--	12
Printing from PC	Flashing	--	--	OFF	OFF	--	13
Scanner operation from PC	Flashing	--	--	OFF	OFF	--	13
Printing & job being canceled	Flashing	--	--	--	--	--	14
Memory card being recognized	Flashing	--	--	--	--	Flashing 3	15
Power ON (Print data processing)	Flashing	--	--	--	--	--	16
Hub connection error	--	Flashing 2	OFF	Flashing 2 of "H"	--	--	17
Camera direct error	--	Flashing 2	OFF	Flashing 2 of "P"	--	--	18
Memory card error	--	Flashing 2	OFF	Flashing 2 of "1"	OFF	--	19

Continued on next page

Table 1-21. CX7300/TX200 series LED Functions

Printer Status	LED						Priority
	Power	Error	Ink	7 Segments	Paper 1/2	Card Access	
Index sheet error (incorrect placement of the sheet)	--	Flashing 2	OFF	Flashing 2 of "2"	--	--	20
Index sheet error (unmatch between the sheet and memory card)	--	Flashing 2	OFF	Flashing 2 of "4"	--	--	21
Index sheet error (incorrect markings on the sheet)	--	Flashing 2	OFF	Flashing 2 of "3"	--	--	22
Ink level low error	--	--	Flashing	--	--	--	23
In copy mode	--	--	--	Displays remaining number of copies*3	ON (selected side)	--	24
In DPOF mode	--	--	--	ON of "d"	ON (selected side)	--	24
In camera direct mode	--	--	--	ON of "P"	ON (selected side)	--	24
Power ON (normal idle state)	ON	--	--	--	--	--	25
No memory card	--	--	--	--	--	OFF	--
Memory card recognized	--	--	--	--	--	ON	--
Memory card being accessed	--	--	--	--	--	Flashing 3	--
Power ON (panel low power mode)	ON	OFF	OFF	" " Low-speed flashing	OFF	--	--

Note \*1: Nothing changes in the normal stand-by status.

\*2: Both LEDs turn OFF in the normal stand-by status.

\*3: "≡" is displayed when continuous 20 sheets is selected.

Note : --: No change  
 Flashing: Repeats ON and OFF every 1.25 seconds.  
 Flashing 2: Repeats ON for 0.5 second, OFF for 0.5 second, ON for 0.5 second, and OFF for 1.0 second.  
 Flashing 3: ON and OFF according to the memory card access status.  
 High-speed flashing: Repeats ON and OFF every 0.5 second.  
 Low-speed flashing: Repeats ON and OFF every 2 seconds.

Note : See "3.3 Error Indications and Fault Occurrence Causes" (p.61) for remedies for errors.

### 1.6.2.3 Control Panel Power Saver Mode

If no operation is made on the control panel for approximately 13 minutes, both the CX8300/TX400 series and CX7300/TX200 series automatically enter control panel power saver mode. The details of control panel power save mode are shown below.

- **Conditions for not entering the control panel power save mode**
  - The printer or scanner is in operation
  - During printing or scanning from PC
  - Camera direct is in operation
  - Slide show is being displayed
  - An error is being displayed
  - Mechanical adjustment is being made in setup mode
  - Firmware is being updated
- **Conditions recovering from the control panel power save mode**
  - Any button other than the power button is pressed (when the power button is pressed, the power is turned OFF)
  - A memory card or a camera direct device is connected
  - Operation from PC (printing / scanning / maintenance)

**NOTE:** See “1.7.3.4 Operating Specifications during Connecting DSC (p.37)” for information on the panel operation during connecting a camera to the EXT.IF.

## 1.7 Specification for Each Function

### 1.7.1 Stand-alone Copy Function

#### 1.7.1.1 Supported Paper and Copy Mode

**Table 1-22. Supported Paper and Copy Mode for CX8300/TX400 series**

Paper Type	Size*1	Print Quality	Resolution	Dot Size	Bi-D	Micro Weave	Borderless
Plain paper	A4*1, Letter*1	Draft	360x120	Eco	ON	OFF	NA
		Standard	360x360	VSD1	ON	OFF	NA
		Best	720x720	VSD3	ON	ON	NA
Matte paper	A4*1, Letter*1	Standard	1440x720	VSD3	ON	ON	OK
Photo Paper	4x6, 5x7, A4*1, Letter*1	Standard	1440x720	VSD3	ON	ON	OK*2
Prem. Glossy	4x6, 5x7, A4*1, Letter*1	Standard	1440x720	VSD3	ON	ON	OK
Ultra Glossy	4x6, 5x7, A4*1, Letter*1	Standard	1440x720	VSD3	ON	ON	OK

Note \*1: The model for Latin supports both the letter and A4 sizes. The model for North America supports letter size only, and the other destination models support A4 size only.

\*2: Borderless printing of 5x7 size is not supported for EAI.

**Table 1-23. Supported Paper and Copy Mode for CX7300/TX200 series**

Paper Type	Size	Print Quality	Resolution	Dot Size	Bi-D	Micro Weave	Borderless
Plain paper	A4*1, Letter*1	Draft	360x120	Eco	ON	OFF	NA
		Standard	360x360	VSD1	ON	OFF	NA
Photo Paper (Photo Paper, Prem. Glossy, Ultra Glossy)	4x6	Standard	1440x720	VSD3	ON	ON	OK

Note \*1: The model for Latin supports both the letter and A4 sizes. The model for North America supports letter size only, and the other destination models support A4 size only.

#### 1.7.1.2 Stand-alone Copy Menu

The stand-alone copy mode menu for the CX8300/TX400 series and CX7300/TX200 series (settable items) are shown in the following tables.

**Table 1-24. Copy Menus for CX8300/TX400 series**

Menu	Function	
Number of copies	Sets the number of copies within the range of 1 to 99.	
Copy type	Selects either color or monochrome.	
Layout	Selects from the following two layouts: <ul style="list-style-type: none"> <li>• With Border (normal layout with 3mm margins)</li> <li>• Borderless (no margins)</li> </ul>	
Print setting	Paper type	Selects paper type from the options shown in <a href="#">Table 1-22</a> .
	Paper size	Selects paper size from the options shown in <a href="#">Table 1-22</a> .
	Quality	Selects print quality from the options shown in <a href="#">Table 1-22</a> .
	Zoom	Selects Actual or Auto Fit Page. Or reduction/enlargement ratio can be specified within the range of 25% to 400%.
Density	Selects from the nine density levels of -4 to +/-0 to +4.	
Expansion (for borderless print)	Selects the margins level (margins bleed off the edges of paper) from the Standard (100%), Mid. (50%) or Min. (0%).*	

**Table 1-25. Copy Settings for CX7300/TX200 series**

Setting Item	Operation and Function	
Number of copies	Sets the number of copies within the range of 1 to 99 using the Copies button.	
Copy type	Selects either color or monochrome with the Color button or B&W button.	
Layout	Selects print layout from the following three options: <ul style="list-style-type: none"> <li>• Standard (normal layout with 3mm margins)</li> <li>• Small margin (layout with 1.5mm margins)</li> <li>• Borderless (no margins)</li> </ul>	
Print setting	Paper type	Selects paper type and size from the options shown in <a href="#">Table 1-23</a> using the Paper Type button.
	Paper size	
	Quality	Selects print quality from the options shown in <a href="#">Table 1-23</a> .
	Zoom	Actual size is selected by default. Autofit can be set by holding down the B&W / Color button for 3 seconds or longer.

### 1.7.1.3 Relation Between Original and Copy

The scanning start position is located on the front right of the scan bed. The relations between the original placed face down and its copy are as follows.

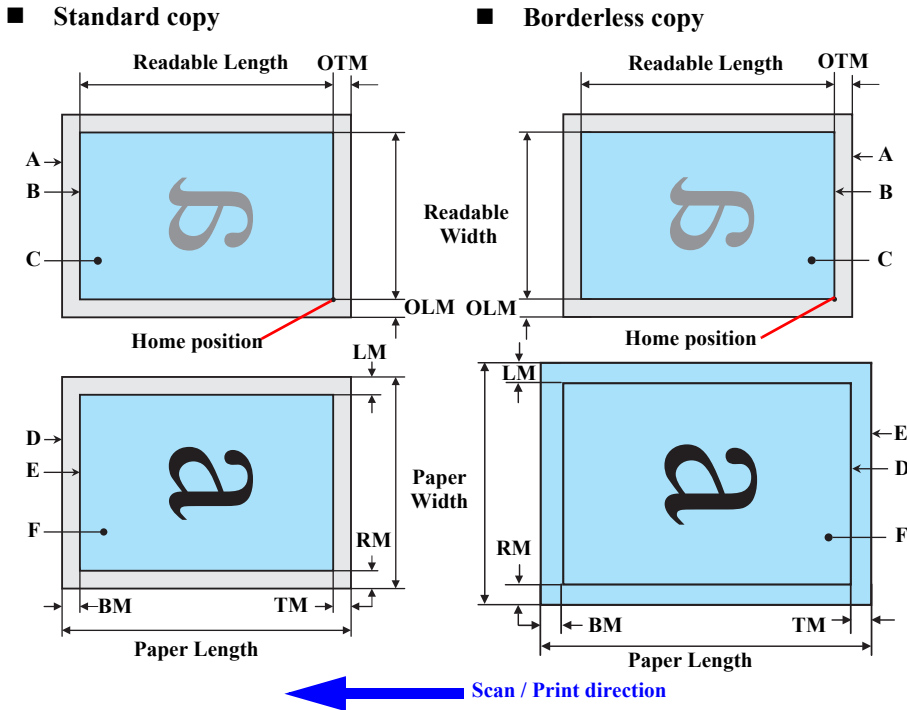


Figure 1-7. Relation Between Original and Copy (Borderless/With Borders)

### 1.7.1.4 Copy Speed

Table 1-26. Copy Speed

Copy Conditions (eMemo2, A4 size)		Model	
		CX8300/TX400 series	CX7300/TX200 series
Draft 360 x 120	Monochrome copy	T.B.D. cpm	T.B.D. cpm
	Color copy		
Default 360 x 360	Monochrome copy	T.B.D. cpm	T.B.D. cpm
	Color copy		T.B.D. cpm

#### Original Document

A	Scan bed	---
B	Scan area	“1-9 Scanning Range” (p.15)
C	Original (face down)	---
OTM	Top margin (out of scan range)	“1-9 Scanning Range” (p.15)
OLM	Left margin (out of scan range)	“1-9 Scanning Range” (p.15)

#### Copied Document

D	Copied paper	---
E	Print area	“1-7 Printing Area (Margins)” (p.15)
F	Copy	---
LM, RM	Left margin, Right margin*	“1-7 Printing Area (Margins)” (p.15)
TM, BM	Top margin, Bottom margin*	

## 1.7.2 Memory Card Direct Print Function

### 1.7.2.1 Supported Paper and Print Mode

Table 1-27. CX8300/TX400 series Supported Paper Type & Print Mode

Paper Type	Size	Print Quality	Resolution	Dot Size	Bi-D	Micro Weave	Borderless
Plain Paper	A4, Letter*1	Standard	360x360	VSD1	ON	OFF	NA
		Best	720x720	VSD3	ON	ON	NA
Matte Paper	A4	Standard	1440x720	VSD3	ON	ON	OK
Photo Paper	4x6, 5x7*2, A4, Letter*1	Standard	1440x720	VSD3	ON	ON	OK
Prem. Glossy	4x6, 5x7, 16:9wide*2, A4, Letter*1	Standard	1440x720	VSD3	ON	ON	OK
Ultra Glossy	4x6, 5x7, A4, Letter*1	Standard	1440x720	VSD3	ON	ON	OK

Note \*1: Letter size is supported for EAI only.

\*2: The Photo Paper 5x7 size and Prem. Glossy 16:9wide are not supported for EAI.

Table 1-28. CX7300/TX200 series Supported Paper Type & Print Mode

Paper Type	Size	Print Quality	Resolution	Dot Size	Bi-D	Micro Weave	Borderless
Plain Paper*1	A4, Letter*3	Standard	360x360	VSD1	ON	OFF	NA
Prem. Glossy *2	4x6, 5x7, 16:9wide*4, A4, Letter*3	Standard	1440x720	VSD3	ON	ON	OK

Note \*1: For printing an Index Sheet.

\*2: For printing images according to the information read from the Index Sheet.

\*3: Letter size is supported for EAI only.

\*4: The 16:9wide is not supported for EAI.

### 1.7.2.2 Supported File Type and Media Type

The followings describe the file system, media format, and file type supported by the memory card direct function.

Table 1-29. Supported File System, Types and Media Format

Item		Specification
File system		DCF Version 1.0 or 2.0 *1 compliant. Other than those does not ensure proper operation. File systems available with the card reader function are restricted by the host's specification.
Media format	Memory card	<ul style="list-style-type: none"> <li>• DCF Version 1.0 or 2.0 compliant</li> <li>• DOS FAT format (FAT12/FAT16/FAT32 *2) with single partition (basic partitioned)</li> </ul>
File type	JPEG (*.JPG)	Image files conform to Exif Version 2.21. (Exif version 1.0/2.0/2.1/2.2/2.21 are supported)
	Camera definition file (*.MRK)	Camera definition files used for DPOF mode. "MISC\AUTOPRINT.MRK" file is valid.

Note \*1: Refer to the Camera File System Standard; "DCF Version 2.0, JEIDA-CP-3461" for more details.

\*2: Available only when the memory card supports FAT32.



**The printer does not detect any files stored under the following directories or their sub-directories.**

- Directories containing system properties or hidden properties.
- "RECYCLED" (Windows directory for deleted files)
- "PREVIEW" (directories of CASIO DSC for thumbnail images)
- "SCENE" (directories of CASIO DSC for its Best Shot function)
- "MSSONY" (directories of SONY DSC for e-mail images, voice memos, movies, or non-compressed images)
- "DCIM\ALBUM\IMAGE" (directories of CASIO DSC for its album function)

### 1.7.2.3 Automatic Detection of Images in Memory Card

When a memory card is inserted in the card slot on the printer, or when a memory card is detected at power-on, the printer automatically searches for all images stored in the card. When the card is removed, the printer erases the information on the all detected files.

### 1.7.2.4 Specifications for Handling Image Data

Table 1-30. Specifications for Handling Image Data

Item	Specification	Remarks
Image size (pixel)	<ul style="list-style-type: none"> <li>• Horizontal: <math>80 \leq X \leq 9200</math></li> <li>• Vertical: <math>80 \leq Y \leq 9200</math></li> </ul>	---
Maximum number of images	Up to 999 images	When a memory card stores 1,000 or more images, the first 999 images are detected and become valid in the printer. The detecting order varies depending on the folder configuration in the card, so which images are included in the first 999 cannot be defined. However, images specified by camera definition files can be selected to be printed even when the total number of images has exceeded 999. Up to 999 camera defined image files can be specified.
Maximum number of copies	99 copies for each image. Up to 999 sheets in total.	---
Valid date and time	01/01/1980 00:00:00 to 12/31/2099 23:59:59	---
Thumbnail image data	Supports DCF Ver.1.0 or 2.0-compatible data (Exif format, 160x120 pixels)	Thumbnail images are used for the Print Index Sheet function.
File sorting	The printer sorts image files in ascending ASCII order based on their full-pathnames such as “\DCIM\100EPSON\EPSN0000.JPG”, and assigns a number to each of them.	<ul style="list-style-type: none"> <li>• The image number assigned by the printer may be different from that assigned by the camera.</li> <li>• If two or more files have the same full pathname, the sorting function may not operate properly. (existence of the same full-pathname is not allowed under DOS)</li> </ul>

Table 1-30. Specifications for Handling Image Data

Item	Specification	Remarks
Acquisition of date and time information	<p>The printer acquires date and time information included in image files in the order of precedence shown below.</p> <ol style="list-style-type: none"> <li>1. Shooting date and time information in digital camera standard format (Exif)</li> <li>2. Digitized date and time information in digital camera standard format (Exif)</li> <li>3. Date and time information in digital camera standard format (Exif)</li> <li>4. Date and time information applied on DOS-compliant file system.</li> <li>5. Fixed date and time information (01/01/1980, 00:00:00)</li> </ol>	Date and time information included in an image file is not always the shooting date and time. It changes each time the image is edited and restored. The printer acquires the latest date and time information.



### 1.7.2.5 Memory Card Direct Print Menu (CX8300/TX400 series)

The LCD-equipped CX8300/TX400 series provide the following menus in the memory card mode. CX7300/TX200 series supports the Print Index Sheet function.

**Table 1-31. Memory Card Mode Menu**

Menu Item	Function
View and Print Photos*1,3	Prints the selected images.
Print All Photos*1,3	Prints all images in a memory card. Specified number of copies is applied to the all images (the default is 1 copy). Specifying it for each of the images independently also can be made in the preview screen.
Print by Date*1	The date of the images are listed in the descending order with the number of images by date. Selecting date from the list selects the images that has the selected date information. Specified number of copies is applied to the selected images (the default is 1 copy). Specifying it for each of the images independently also can be made in the preview screen.
Print Index Sheet (Also available on CX7300/TX200 series)	<b>Print Index Sheet*2</b> Prints an index sheet that prints images in a memory card in thumbnail form. The number of images to be included in the sheet can be selected from the following four options. “All image” (default), “Latest 30”, “Latest 60”, “Latest 90”*3
	<b>Make Prints from Index Sheet</b> Scans the index sheet, and prints images according to markings written on the sheet.
Slide Show*4	Starts a slide show on the LCD. Images in a memory card is displayed one by one in the order sorted by the printer. Printing one of the images can be made from the paused screen.

- Note \*1: 0 to 99 copies can be specified for each of the images. Up to 999 copies in total.  
 \*2: For CX7300/TX200 series, press the [Print Index Sheet] button to print the index sheet. All images in a memory card are included in the sheet.  
 \*3: The images are listed in ASCII descending order.  
 \*4: While performing the slide show, displaying number of copies, printing from an external device or from a computer cannot be made.

### 1.7.2.6 Makes Prints from Index Sheet Function

Print settings

**Table 1-32. Print Settings**

Item	Print Index Sheet	Makes Prints from Index Sheet
Number of copies	---	According to the marking on the index sheet.
Paper Type	Plain paper	
Paper Size	A4	
Layout	---	
Quality	Standard	Standard
Expansion	---	According to the setting made by the control panel.
Date	YYYY.MM.DD (2007.09.21)*1	According to the setting made by the control panel. YYYY.MM.DD (2007.09.21)*1
BiDirectional	On	On
Print Index Sheet Setting-Select*2	According to the setting made by the control panel.	---

- Note \*1: EAI model: MMM.DD.YYYY (Sep. 21.2007)  
 \*2: CX8300/TX400 series only. CX7300/TX200 series do not support it.



Rules on reading Index Sheet markings

The user can specify images to be printed and their print settings shown in [Table 1-32](#) by putting marking on the Index Sheet. The printer reads the markings according to the following rules.

**Table 1-33. Rules on Reading Markings**

Item	Mark	Description	Remarks
Left edge (one each)		Reference position for reading markings.	An error occurs if these markings cannot be read due to ink stain or any other cause.
Right edge (one each)		Reference position for reading markings.	
Block code (36 pcs.)		Sheet information (memory card, page)	
Image selection (30 pcs. x 3)		Selects the image to be printed.	An error occurs if no image selection marking is read.
Paper type/size (4 pcs.)		Selects the paper type/size.	An error occurs if two or more markings are read for one image.

Table 1-33. Rules on Reading Markings

Item	Mark	Description	Remarks
Layout (2pcs.)		Selects the layout.	An error occurs if two or more markings are read for one image. If no marking is read, borderless layout is applied.
Date		Prints the date information	When this marking is read, the date is printed on the image.

- Note:
- About 50% or more range of the mark area must be marked out to be read by the printer.
  - For running out and excessive marking out, the two white/black search patterns shown above are superimposed on the mark, and judgement is made according to this matching ratio.
  - The judgement criteria is as follows;  
black matching: 80% or more, white matching: 50% or more.
  - The figure below shows the judgement example according to the rules described above.



□ Index Sheet errors

Table 1-34. Index Sheet Error List

Error Name	Description
Index sheet scan error (incorrect sheet setting)	The Index Sheet is not properly placed on the document glass.
Index sheet scan error (incorrect image selection marking)*	Image selection markings are not correct.
Index sheet scan error (incorrect paper selection marking)	Paper selection markings are not correct.
Index sheet scan error (unmatch between memory card and sheet)	The memory card may have been changed or some images may have been added or deleted after the Index Sheet is printed.

1.7.2.7 Print Layout

The memory card direct print function supports two print layouts for printing images; Borderless, and With Border. The Borderless layout is not allowed for some type of paper (refer to Table 1-27 and Table 1-28). And see “1.2.5 Printing Area” (p.15) for information on the print area and margins of “Borderless” and “With Border” layouts.

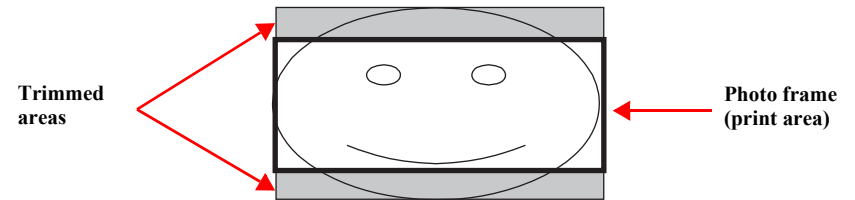
□ Trimming Function

A trimming function is provided as a means of coordinating an image with the types of photo frames handled by the printer. This function is always activated so that the image fits within the photo frames.

This function is described briefly below.

The printed photo frame and an image to be printed are matched in length along one side and the image is resized along the perpendicular side to fit the frame on that side. Any part of the image that does not fit within the photo frame is trimmed away (not printed).

- When an image is aligned vertically with the photo frame.



- When an image is aligned horizontally with the photo frame.

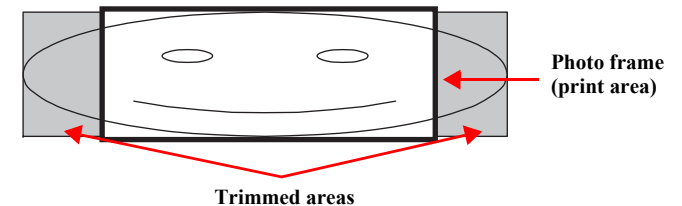


Figure 1-8. Trimming Function

□ Rules on Numbering and Rotating Images

The numbers shown in the figure below indicate the photo frame numbers used for the print layout. Horizontally oriented images are printed as shown by the numbers. Vertically oriented images, which has more pixels vertically than horizontally, the vertical photo data is allocated instead, and the number shown in the figure below is then rotated 90 degrees before being printed. In Index printing mode, the numbers are printed as they are shown below, regardless of the shape of the photo data.

However, when the photo data has an equal number of pixels vertically and horizontally the photos are printed without rotation, regardless of the layout.

**NOTE:** *The vertical photo data refers to when the photo data file itself is set for a vertical (portrait) orientation. Photo data is defined as the vertical photo data if it is taken by a digital camera with a portrait position detecting function.)*

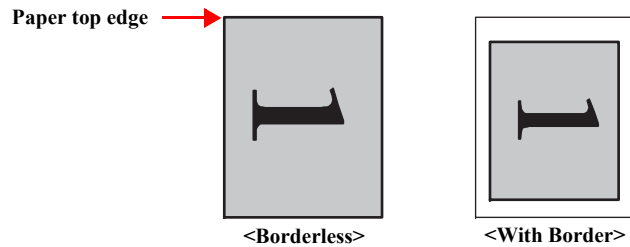


Figure 1-9. Rules on Numbering and Rotating Images

### 1.7.3 Camera Direct Print Function (USB Direct Print/PictBridge)

Printing operations (selecting images to be printed, making print settings, starting/canceling printing, and monitoring print process) can be carried out from a directly connected DSC (Digital Still Camera) that conforms to the standard described below.

#### 1.7.3.1 Available DSC

Table 1-35. Available DSC

USB Direct Print	PictBridge
DSCs conform to USB Direct Print Protocol Revision 1.0.	DSCs conform to CIPA DC-001-2003 Digital Photo Solutions for Imaging Devices (DPS version 1.0) or the Rev. 2.0.

#### 1.7.3.2 Print Settings Available from DSC

The following print settings can be made from the DSC. However, depending on the DSC, some of the settings may not be available.

Table 1-36. Print Settings Available from DSC

Item	USB Direct Print	PictBridge
How to specify images	Single Sheet / DPOF specified	Single Sheet / Multiple Sheet / DPOF specified
Paper type (this cannot be specified for CX7300/TX200 series)	Plain Paper/ Glossy Photo / Prem. Glossy / Matte	Plain Paper/ Prem. Glossy
Paper size	4x6, 5x7, Letter (EAI model only), A4 (CX7300/TX200 series for Euro: 4x6, A4) (CX7300/TX200 series for EAI: 4x6, Letter)	
Layout	Borderless With Borders (2-up, 4-up, 8-up are available when specified by DPOF)	Borderless With Borders (cannot be specified for CX7300/TX200 series)
Date	On / Off	
Quality	Not available	
Auto Correct	Not available	
Fit to Frame	Available only for a single sheet	Available
Print Image Framer	Yes / No	Not available
Control of printer	The following operations are available; Getting the printer status, starting a print job or canceling it immediately or after printing the current page is finished. (In the case of the USB Direct Print, resetting the printer is also available.)	

#### 1.7.3.3 General Operation Procedure



**Before connecting the DSC, check that the printer is in the following status.**

- No print job from a computer is processed or performed.
- Direct print from a memory card is not processed or performed.
- Stand alone copy using the scanner function is not operating.
- No paper out error or ink out error is occurring.

The DSC direct print procedure differs depending on the DSC specifications. The following explains common procedure.

1. Setting on the printer  
Before connecting a DSC with a USB cable, make the print settings such as paper type/size, layout setting on the printer. This may not be required for some DSCs.
2. Setting on the DSC  
Make the following settings on the DSC before connecting it to the printer. Some DSCs may require to first connect to the printer for making the settings.
  - When printing multiple images, specify images and number of copies using the DPOF and Multiple Sheet\* menus. The menus may not be available on some DSCs.  
Note\*: The Multiple Sheet setting is available when using PictBridge.
  - When printing a single image  
<USB Direct Print>  
Use the Single Sheet menu to specify an image and the number of copies. The menu may not be available on some DSCs.  
<PictBridge>  
Specify an image and the number of copies. Specifying the number of copies may not be available on some DSCs.
  - Select the paper type/size, layout, and make the Fit to Frame setting if necessary. These settings may not be available on some DSCs.
3. Starting to print  
When the print settings on both the printer and the DSC is completed, follow the procedure below to start printing.
  1. Connect the printer and the DSC with a USB cable. Using a USB cable included in the DSC package is recommended.
  2. Operate the DSC to start printing.
  3. Printing is carried out according to the settings made on the DSC. When some print settings have not been made on the DSC, the corresponding settings made on the printer are applied.

### 1.7.3.4 Operating Specifications during Connecting DSC

Table 1-37. Operations during Connecting DSC

Operation	Specifications
Connecting DSC (print start)	When a DSC is connected as described in “1.7.3.3 General Operation Procedure (p.36)” Step 3-(1), CX8300/TX400 series displays USB Direct Print or PictBridge logo on the LCD. On the CX7300/TX200 series, the Power LED flashes and “P” is displayed on the 7 seg LED.
Canceling printing	A print job can be canceled from the DSC. The [Stop/Clear setting] button on the CX8300/TX400 series, and the [Stop] button on the CX7300/TX200 series also cancels the print job.
After printing is completed	When performing memory card direct print after printing from a DSC, the USB cable connecting the DSC must be disconnected from the printer in advance.
Exclusion control	Print settings made on both the DSC and the printer can become impossible settings for the printer due to unsupported combination of paper type, paper size and layout. In such case, the print settings are automatically changed as follows.  <input type="checkbox"/> USB Direct Print The selected paper type is maintained, and the paper size and layout settings are changed to the default for the selected paper type.  <input type="checkbox"/> PictBridge The settings made on the DSC are maintained. Any print setting items that are not specified by the DSC are changed in accordance with the DSC settings. When the paper type is changed, changed to Prem. Glossy, when the paper size is changed, changed to 4x6 size. And when the layout is changed, changed to Borderless layout.

### 1.7.3.5 EXT.I/F (USB Host) Specifications for Connecting DSC

Table 1-38. Operations when USB Cable is Connected/Disconnected

Printer status	Connecting	Disconnecting
Standby	When the printer detects a DSC connected, it goes into the camera direct mode. If the printer failed to recognize the DSC normally, the printer displays a camera direct error.	When the DSC is disconnected after it is normally recognized by the printer, the printer returns to the standby mode.
An error is occurring	The printer does not go into the camera direct mode except when the error is memory card-related error, Index Sheet error, or Ink low error.	When a camera direct error has occurred, the printer recovers from the error and returns to the previous state (the state before the camera is connected). If the error occurs for the camera connected before the printer is turned on, the printer returns to the initial state after the power-on.
Panel power save mode	Same as when the printer is in standby mode.	The printer does not recover from the power save mode. When any button except the Power button is pressed, the printer returns to the camera direct mode. If the printer detect no camera at this time, it returns to the previous state (the state before the camera is connected)

Table 1-39. Handling Print Job Requirement from PC when Connecting DSC

Requirement from PC	EXT.IF (USB Host) DSC Connecting Status	
	Normally Connected	Camera Direct Error is Occurring
Print job	Returns “Busy” to the PC.	Cancels the error state and performs the job.
Scan job	Returns “Busy” to the PC.	Cancels the error state and performs the job.
Read memory card	Allows the access.	Allows the access.
Write memory card	Not allows the access. Notifies the PC that the operation is not available.	Allows the access.
Maintenance	Returns “Busy” to the PC.	Cancels the error and carries out the required task.

### 1.7.4 Reprint/Restore Photos Function (CX8300/TX400 series only)

CX8300/TX400 series offers the photo copy function. This function allows the user to copy their silver halide film-based pictures. The printer scans the pictures automatically detecting them as silver halide film-based picture, and makes a copy of them.

#### 1.7.4.1 Supported Paper Type and Print Mode

Table 1-40. Paper Type and Print Mode

Paper Type	Size	Quality	Resolution	Dot size	Bi-D	Micro Weave	Borderless
Matte paper	A4, Letter*1	Standard	1440x720	VSD3	ON	ON	OK
Photo Paper	4x6, 5x7*2, A4, Letter*1	Standard	1440x720	VSD3	ON	ON	OK
Prem. Glossy	4x6, 5x7, A4, Letter*1	Standard	1440x720	VSD3	ON	ON	OK
Ultra Glossy	4x6, 5x7, A4, Letter*1	Standard	1440x720	VSD3	ON	ON	OK

Note \*1: Letter size is supported for EAI only.

\*2: The Photo Paper 5x7 size is not supported for EAI.

#### 1.7.4.2 Reprint/Restore Photos Menu

Table 1-41. Reprint/Restore Photos Menu

Items	Function
Number of copies	Sets the number of copies within the range of 1 to 99.
Paper type	Selects paper type from the options shown in Table 1-40.
Paper size	Selects paper size from the options shown in Table 1-40.
Layout	Selects print layout from the following three options: <ul style="list-style-type: none"> <li>• Standard (normal layout with 3mm margins)</li> <li>• Borderless (no margins)</li> </ul>
Quality	Fixed to "Standard".
Expansion	Selects the margins level (margins bleed off the edges of paper) from the Standard (100%), Mid. (50%) or Min. (0%).
Color restoration	Selects from On or Off. The default is Off.

### 1.7.4.3 How to Place Silver Halide Pictures

The following explains how to place silver halide film-based pictures on the document glass of the printer.

- Available picture size: 30x40 mm to 127x178mm (5"x7")
- Lay the pictures on the glass face down.
  - The number of pictures available at one time is as follows:
    - 4x6 or smaller: up to 2 pictures
    - 5x7: up to 1 picture
- The following spaces are needed:
  - 5 mm or more space from the right and front edges of the document glass.
  - 5 mm or more space between pictures.
- The pictures must not be tilted.

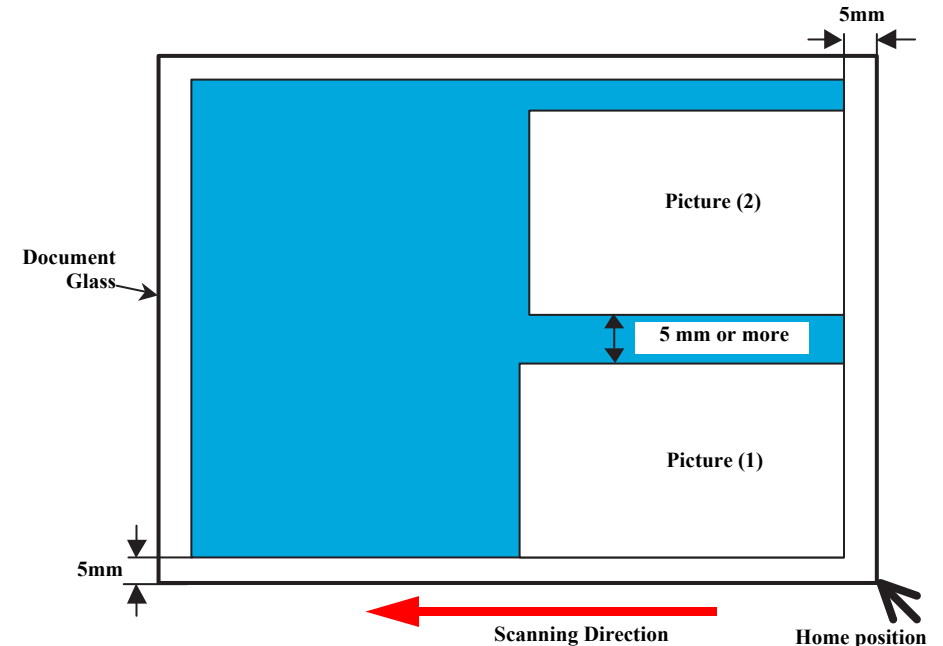


Figure 1-10. Laying Silver Halide Pictures

## 1.7.5 Setup Mode

CX8300/TX400 series go into the setup mode when the Setup button is pressed. CX7300/TX200 series go into the mode by special button operation. Various maintenance functions and configuration settings can be made in this mode.

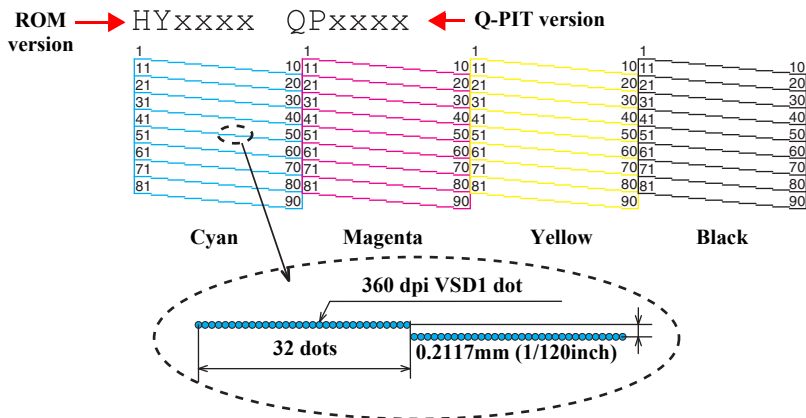
### 1.7.5.1 Ink Levels (CX8300/TX400 series only)

The current ink levels of each of the cartridges are displayed in bar chart by the rules described below. After displaying the ink levels, the next operation can be selected from the following two options; “End the ink levels display” or “Change Ink Cartridge”.

- The bar chart is displayed in the order of cyan, magenta, yellow, and black from the left.
- When initial filling is completed, or after replacing the cartridge, the ink level becomes 100% (full).
- The ink level is indicated in increment of 1%. Lower than 1% is rounded down.
- When the ink level becomes lower than 10%, “!” icon appears to notify the user of the ink low status.

### 1.7.5.2 Nozzle Check

A nozzle check pattern to check the Printhead nozzles status is printed. A head cleaning can be run if necessary. For CX7300/TX200 series, turn the power On while holding down the Stop button to print the nozzle check pattern.



Note : The numbers shown in the figure are nozzle numbers. The numbers and the color names are not printed on an actual nozzle check pattern. The ROM version sample shown in the figure is one for the CX8300 series. “ELxxxx” is printed for CX7300 series. “ERxxxx” is printed for TX200 series. “HRxxxx” is printed for TX400 series.

Figure 1-11. Nozzle Check Pattern

### 1.7.5.3 Head Cleaning

Runs a printhead cleaning. For CX7300/TX200 series, press the Stop button for more than three seconds to run the cleaning. The cleaning cannot be made when low ink level is detected. In such case, an ink low error is displayed instead of running the cleaning.

### 1.7.5.4 Change Ink Cartridge

CX8300/TX400 series runs the ink cartridge replacement sequence when “Change Ink Cartridge” option is selected in the Ink Levels display menu. And when an ink low or out error occurs, the user can run the replacement sequence by following the instructions displayed on the LCD. CX7300/TX200 series runs the sequence when the Stop button is pressed while an ink-related error is occurring.

### 1.7.5.5 LCD Brightness (CX8300 series only)

This allows the user to adjust the brightness of the LCD. The settable range is -10 (minimum) to +10 (maximum).

### 1.7.5.6 Display Format (CX8300/TX400 series only)

The layout to preview images on the LCD can be selected from the following options; 1-up with Info, 1-up without Info, 16-up. This setting is applied to preview images using the following functions of the memory card mode.

- Print All Photos
- View and Print Photos
- Print by Date
- Slide Show

### 1.7.5.7 PictBridge Setup (CX8300/TX400 series only)

The print settings to be used for the camera direct print (USB Direct Print/PictBridge) can be specified. When print settings (paper type, paper size, layout, quality, auto correct) are specified from the DSC, the DSC settings are applied and the settings made here are ignored.

For more details, see “1.7.3 Camera Direct Print Function (USB Direct Print/PictBridge) (p.36)”.

### 1.7.5.8 Head Alignment

The Head Alignment adjustment is provided to ensure the bi-directional print quality. For CX7300/TX200 series, turn the power On while holding down the Copies button to enter into the mechanical adjustment mode and print the Head Alignment adjustment pattern.

#### □ Adjustment procedure for CX7300/TX200 series

1. Load A4 sized plain paper on the ASF, and turn the power On while holding down the Copies button.
2. The Bi-D adjustment pattern is printed for each of the four dot sizes in the order of ECO color (#1), VSD1 color (#2), VSD2 color (#3), and VSD3 color (#4). When the printing is completed, the printer automatically goes into the adjustment mode.
3. The Paper LED1 lights and 7-seg LED flashes “5”. In this state, an adjustment value for the ECO color (#1) can be entered using the Copies button within the range of 1 to 9. Each press of the button increases the value, and returns to 1 after 9 is reached.
4. After entering a value for the ECO color (#1), press the Start B&W button to accept the value. Then the printer goes into the next VSD1 color (#2) mode. The Paper LED2 lights and 7-seg LED flashes “5” again. Enter the value for the VSD1 color (#2) and press the Start B&W button to accept the value. The printer goes into the next VSD2 color (#3) mode.
5. Repeat the same procedure as above (3) and (4) until the last VSD3 color (#4) is finished. In the VSD2 color (#3) mode, the Paper LED1 flashes, and in the VSD3 color (#4) mode, the Paper LED2 flashes.
6. When entering a value for the last VSD3 color (#4) is finished, the entered adjustment values are reflected on the printer. When finished, the Card access LED and the LEDs except the Paper LED2 flash (the 7-seg LED is Off) and the printer is automatically turned Off.

#### □ Adjustment procedure for CX8300/TX400 series

Follow the instructions displayed on the LCD to carry out the Head Alignment adjustment. As for the CX7300/TX200 series, the default value for each of the four modes is “5”, and can be changed within the range of 1 to 9.



- If the printer power is turned Off during printing the adjustment pattern or entering the adjustment value, the pattern print is canceled, and the values return to the default.
- While the adjustment is carried out, the printer does not go into the panel power save mode.



- If a paper out error occurs, load a paper and press the following button to cancel the error state.  
CX8300/TX400 series: Start button  
CX7300/TX200 series: Start Color button
- If a paper jam error occurs, press the following button to eject the paper. If the paper is ejected normally, the printer recovers from the error and prints the adjustment pattern.  
CX8300/TX400 series: Start button  
CX7300/TX200 series: Start Color button



CHAPTER

2

# OPERATING PRINCIPLES

## 2.1 Overview

This section describes the operating principles of the Printer Mechanism and Electrical Circuit Boards of EPSON Stylus CX7300/CX7400/DX7400/NX200/TX200/TX203/TX209/SX200/SX205 and Stylus CX8300/CX8400/DX8400/NX400/TX400/TX405/TX409/SX400/SX405.

EPSON Stylus CX7300/CX7400/DX7400/NX200/TX200/TX203/TX209/SX200/SX205 and Stylus CX8300/CX8400/DX8400/NX400/TX400/TX405/TX409/SX400/SX405 employs a newly developed printer mechanism that is different from the previous model, Stylus CX4900/CX4905/CX5000/DX5000/DX5050/CX5900/CX6000/DX6000/DX6050. The CIS for the scanner is the same as that of the previous models, however, the origin point is changed to front right from the far left due to the change in appearance.

### 2.1.1 Printer Mechanism

EPSON Stylus CX7300/CX7400/DX7400/NX200/TX200/TX203/TX209/SX200/SX205 and Stylus CX8300/CX8400/DX8400/NX400/TX400/TX405/TX409/SX400/SX405 printer mechanism consists of printhead, carriage mechanism, paper loading mechanism, paper feed mechanism, and ink system.

As the conventional models, EPSON Stylus CX7300/CX7400/DX7400/NX200/TX200/TX203/TX209/SX200/SX205 and Stylus CX8300/CX8400/DX8400/NX400/TX400/TX405/TX409/SX400/SX405 is equipped with two DC motors; one is used to drive the paper loading, paper feed mechanisms, and the pump mechanism that includes the carriage lock mechanism, and another one is used to drive the carriage mechanism. A paper is fed from the rear ASF unit by means of the LD roller and Retard roller and ejected to the front tray.

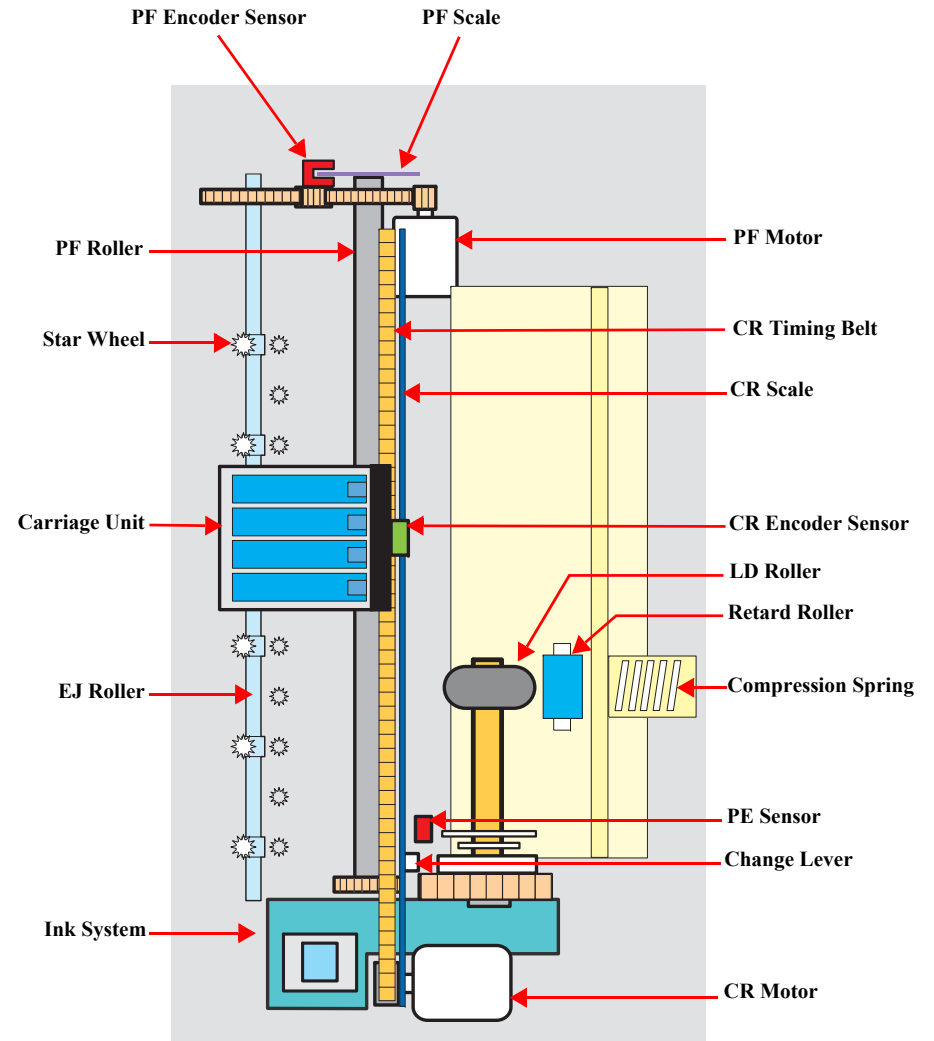


Figure 2-1. Printer Mechanism block diagram

## 2.1.2 Motors & Sensors

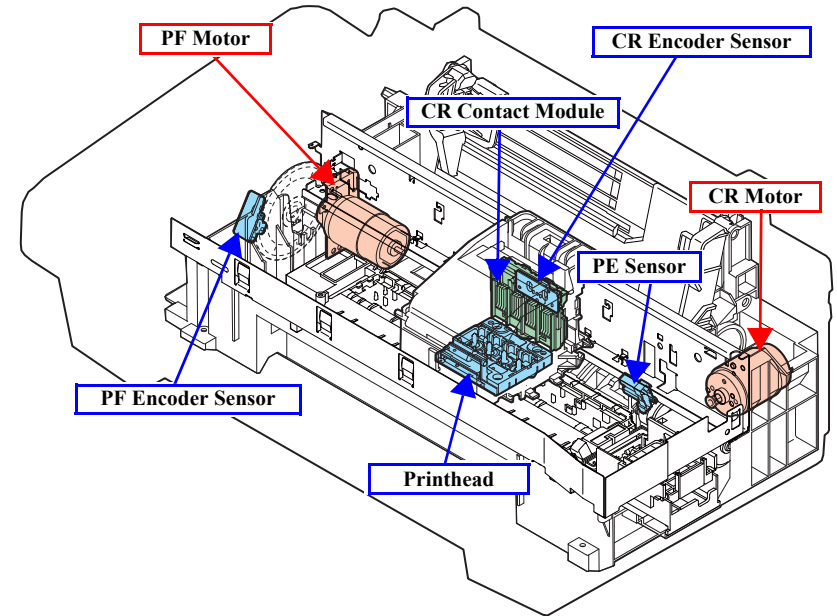
EPSON Stylus CX7300/CX7400/DX7400/NX200/TX200/TX203/TX209/SX200/SX205 and Stylus CX8300/CX8400/DX8400/NX400/TX400/TX405/TX409/SX400/SX405 printer mechanism is equipped with the following printhead, motors and sensors.

**Table 2-1. Printer Mechanism Motors & Sensors**

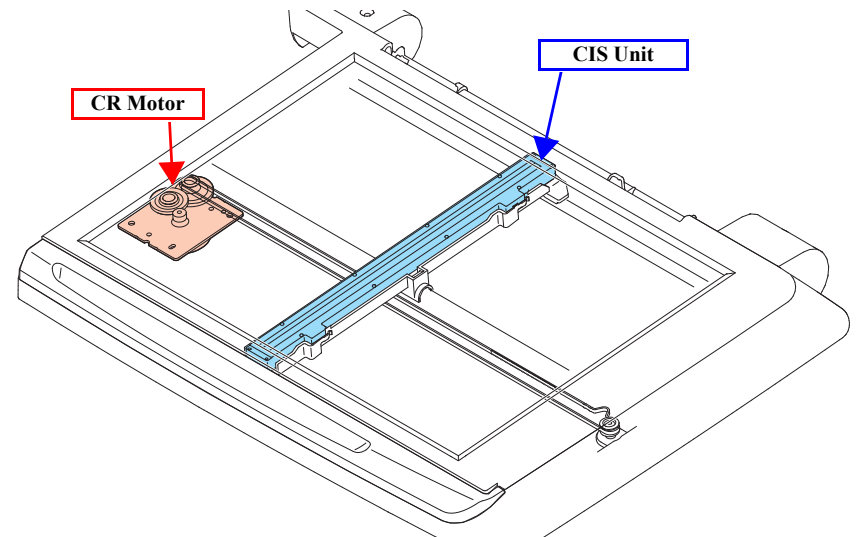
No.	Name	Specification
1	Printhead	D4 Turbo2 head (4 colors x 90 nozzles)
2	CR Motor	Type: DC motor Drive voltage: 42VDC +/- 5% (DRV IC voltage) Coil resistance: 28.8Ω +/- 10% Inductance: 20.1mH (1KHz) Drive method: PWM, constant-current chopping
3	PF Motor	Type: DC motor Drive voltage: 42VDC +/- 5% (DRV IC voltage) Coil resistance: 21.2Ω +/- 10% Inductance: 17.2 mH (1kHz) Drive method: PWM, constant-current chopping
4	PE Sensor	Purpose : Detection of paper top and bottom edge, for control to set paper at the print start position Type: Photo interrupter
5	CR Contact Module	CSIC board
6	CR Encoder Sensor	Type: Photo interrupter Resolution: 180 pulse/inch
7	PF Encoder Sensor	Type: Photo interrupter Resolution: 180 pulse/inch

**Table 2-2. Scanner Mechanism CIS & Motor**

No.	Name	Specification
1	CIS Unit	Resolution: 10200 pixel 16 bit per pixel (input), 8bit per pixel (output)
2	CR Motor	Type: 2-phase 96-pole PM type stepping motor Voltage: 42VDC +/- 10% (DRV IC voltage) Coil resistance: 43Ω +/- 10% (OKI)/48Ω +/- 10% (MITSUMI) (at 25C) Inductance: 24.5mH +/- 20% (OKI)/29mH +/- 20% (MITSUMI) (at 1KHz, 1Vrms) Drive method: PWM



**Figure 2-2. Motors & Sensors in Printer Mechanism**



**Figure 2-3. CIS Unit and CR Motor in Scanner Mechanism**

### 2.1.3 Printhead

D4-CHIPS Turbo2 type printhead is employed, which produces variable sized dot and economy dot. The printhead configuration is as follows.

- Nozzle configuration
  - Black: 90 nozzles x 1
  - Color: 90 nozzles x 3 (cyan, magenta, yellow)

The nozzle layout as seen from behind the printhead is shown below.

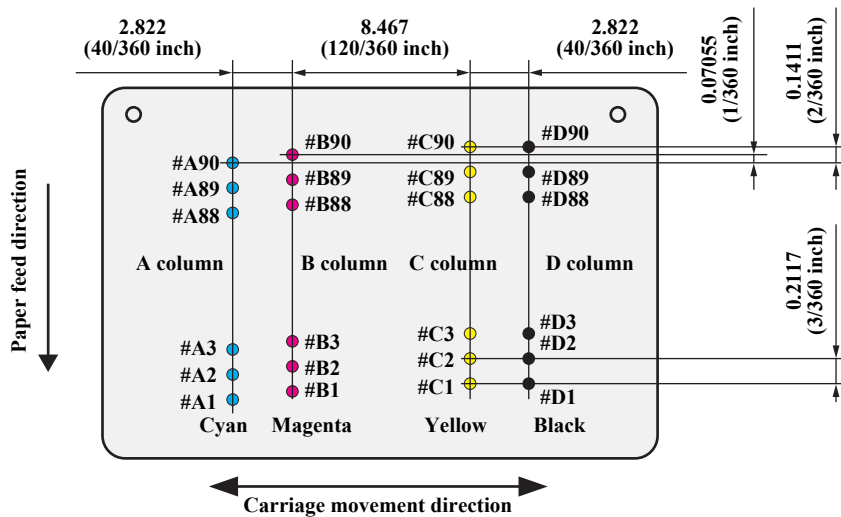


Figure 2-4. Nozzle Layout

The basic operating principles of the printhead, which plays a major role in printing, are the same as the previous printer; on-demand method which uses PZT (Piezo Electric Element). In order to reduce unit-to-unit variation in ink droplet size, the printhead has its own Head ID (16-digits code for EPSON Stylus CX7300/CX7400/DX7400/NX200/TX200/TX203/TX209/SX200/SX205 and Stylus CX8300/CX8400/DX8400/NX400/TX400/TX405/TX409/SX400/SX405) which corrects PZT drive voltage for the printhead.

Therefore, whenever the printhead, main board, or the printer mechanism must be replaced with a new one, the Head ID of the new printhead needs to be written into the EEPROM using the Adjustment Program. The printer generates appropriate PZT drive voltage based on the Head ID information.

Following explains the basic components of the Printhead.

- PZT
 

PZT is an abbreviation of Piezo Electric Element. Based on the drive waveform generated on the main board, the PZT selected by the nozzle selector IC on the printhead pushes the top of the ink cavity, which has ink stored, to eject the ink from each nozzle on the nozzle plate.
- Nozzle Plate
 

The plate with nozzle holes on the printhead surface is called Nozzle Plate.
- Filter
 

This filter is located beneath the ink supply needle which supply ink to the printhead from the ink cartridge. The filter is preventing dirt or dust from getting into the printhead. Any dirt or dust may interrupt normal ink flow or can cause nozzle clog adversely affecting the print quality.
- Ink Cavity
 

The ink absorbed from the ink cartridge goes through the filter and then is stored temporarily in this tank called “ink cavity” until PZT is driven.

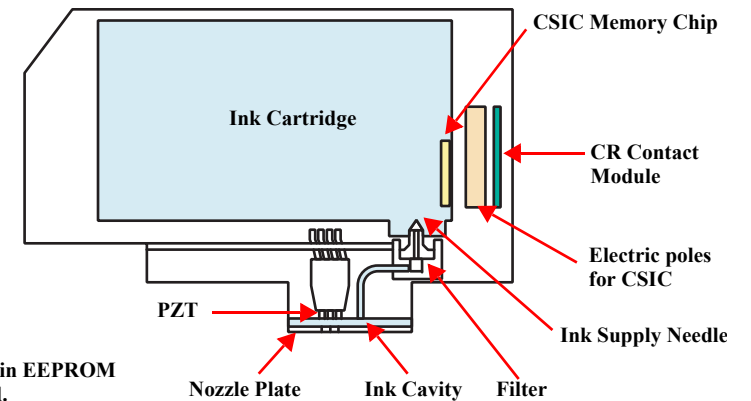


Figure 2-5. Printhead Mechanism

### 2.1.3.1 Printing Process

This section explains how the printhead of the on-demand inkjet printer fires ink drop from each of the nozzles.

1. When not firing ink drop  
When the printing signal is not output from the C690 main board, or the PZT drive voltage is not applied, the PZT does not change its shape. Therefore, the PZT does not push the ink cavity. The ink pressure inside the ink cavity is kept normal. (refer to [Figure 2-6 \(p.45\)](#) “When not firing ink drop”)
2. When firing ink drop  
When the print signal is output from C690 main board, the nozzle selector IC provided on the printhead transmits the data in 1-byte unit. Based on the drive voltage generated on the main board, the PZT selected by the nozzle selector IC pushes the top of the ink cavity. By this operation, the ink stored in the ink cavity is ejected from nozzles. (refer to [Figure 2-6 \(p.45\)](#) “When firing ink drop”)

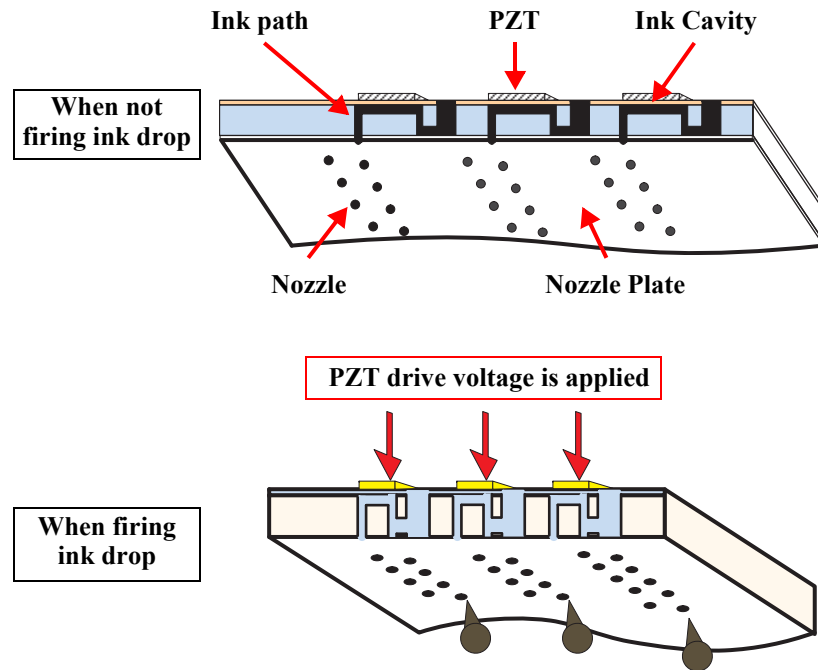


Figure 2-6. How to Fire Ink Drop

### 2.1.3.2 Printing Method

EPSON Stylus CX7300/CX7400/DX7400/NX200/TX200/TX203/TX209/SX200/SX205 and Stylus CX8300/CX8400/DX8400/NX400/TX400/TX405/TX409/SX400/SX405 offers printing with variable sized dot or printing with economy sized dot.

- Variable dot mode  
This mode is developed to improve the print quality on Epson designated paper. Three sizes of dot; micro, middle, and large are automatically selected and used for printing according to the print data, basically the same as conventional models. Superior quality can be achieved on the Epson paper.
- Economy dot mode  
Fixed larger dot is used for printing in economy mode, which enables fast printing with lower resolutions.

## 2.1.4 Carriage Mechanism

The carriage mechanism components include the carriage unit (including printhead, CR encoder sensor), CR motor, timing belt, and CR scale.

The operating principles of the carriage mechanism are described below.

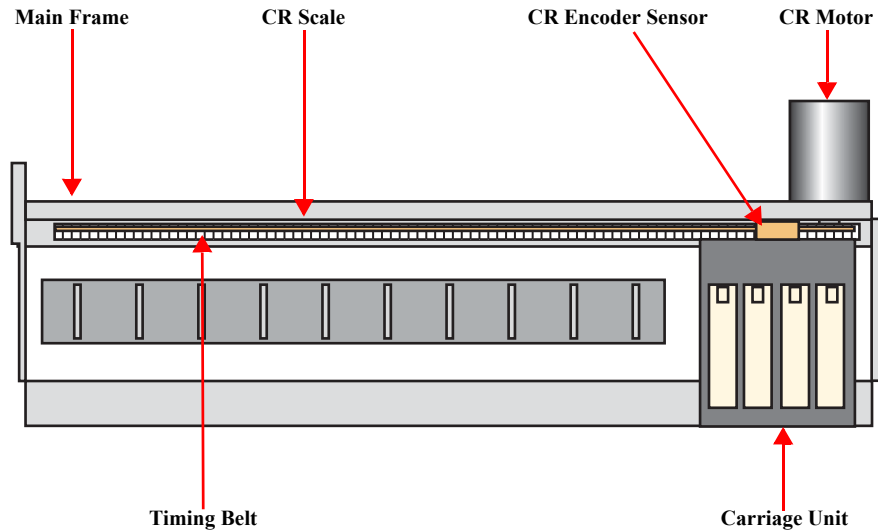


Figure 2-7. Carriage Mechanism

### 2.1.4.1 CR Motor Control

This printer employs closed-loop control, via the CR motor and an encoder, to control the carriage speed and position. Since the CR motor is DC motor, the printer controls the motor in the following methods in order to ensure stable print quality.

- Heat control  
The heat control over the CR motor is carried out based on the electrical characteristic of the motor such as torque constants, coil resistance and power supply voltages.
- CR motor drive dispersion measurement sequence  
Variations in torque constant, coil resistance and power supply voltage of the motor are measured in a CR motor drive dispersion measurement sequence when

the CR mechanical load is in the initial state and saved into the EEPROM. According to the variations measured in the sequence, the voltage is corrected to make the drive current value constant reducing an individual difference.

- CR measurement sequence  
To set the appropriate drive voltage for the CR motor in accordance with variation of the CR motor mechanical load, the printer runs a CR measurement sequence and stores the measured data into the EEPROM at power-on or in an ink cartridge replacement sequence. A fatal error occurs if the printer detects that too much load is applied to the CR motor.

The above control and sequences enable to correct the drive voltage for the CR motor based on the mechanical load and the electrical characteristic of the motor. According to the corrected drive voltage, heating value of the motor is calculated. The printer automatically provides wait time per CR path during printing when the predetermined heating value is reached.

### 2.1.4.2 Carriage Home Position Detection

Like the previous model, the carriage home position is detected by the CR motor drive electric current and carriage speed/position signals sent from the CR encoder. The detection sequence performed at power-on is described below.

1. Drives the CR motor to move the carriage until it contacts with the right frame, and then stops the CR motor. The carriage position is set as a position specified number of counts rightward from the home position.
2. Moves the carriage again to the carriage lock position to check the lock for proper operation.
3. The printer starts to monitor the carriage position through the CR encoder.

The printer causes a fatal error if too much load on the CR motor is detected due to obstruction on the carriage path or if no carriage position information is obtained due to CR encoder or CR scale failure.

## 2.1.5 Paper Loading/Paper Feed Mechanism

The paper loading/feed mechanism are driven and controlled by the PF motor (DC motor) and the PF encoder.

The PF motor drive force is transmitted to the LD roller and the PF roller via the gears in the mechanism. In the loading mechanism, paper is fed to the PF roller from the ASF unit, and the feed mechanism transports the paper during printing and ejects it.

The rotational direction of the PF motor switches between the loading and feed operations as shown in the table below.

**Table 2-3. Rotational Direction of PF Motor & ASF Operations**

Rotational Direction*	Operations
Clockwise	<ul style="list-style-type: none"> <li>Releases the change lever from the clutch mechanism.</li> </ul>
Counterclockwise	<ul style="list-style-type: none"> <li>Feeds a paper into the printer and transports it.</li> <li>Locks the clutch mechanism with the change lever.</li> </ul>

Note "\*": Rotational direction of the PF motor pinion gear as seen from the left side of the printer.

Figure 2-8 shows how the PF motor drive is transmitted to the LD roller and the PF roller. (The numbers in the figure indicate the sequence of the drive transmission.)

The PE sensor detects the paper top and bottom edges during the loading and feeding operations. When the sensor could not detect the top edge of paper during the loading operation, the printer causes a paper out error. And when the sensor could not detect the bottom edge of paper during feeding operation, the printer causes a paper jam error. For more details on the errors, see [Chapter 3 "TROUBLESHOOTING" \(p58\)](#).

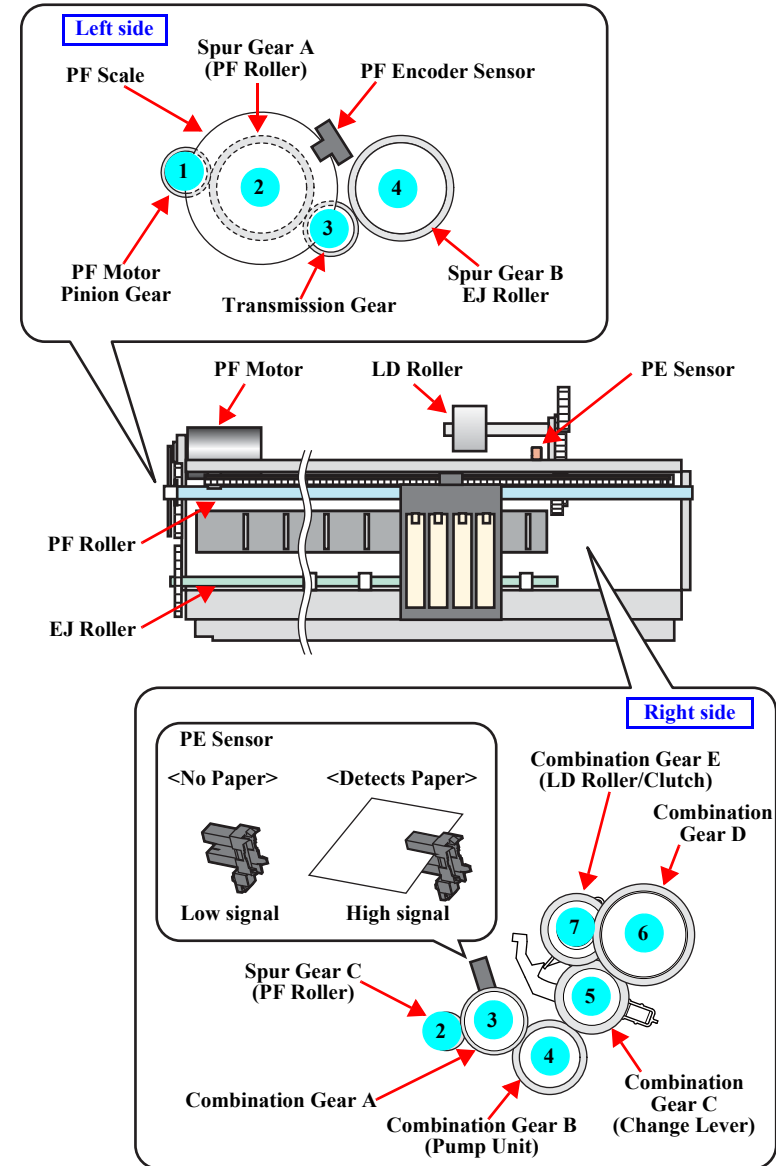


Figure 2-8. Paper Loading/Feed Mechanism

### 2.1.5.1 Paper Loading Mechanism (ASF Unit)

The paper loading mechanism loads paper from the ASF unit and feeds paper to the PF roller. The ASF unit includes the hopper, change lever, LD roller shaft, and clutch mechanism.

The change lever and the clutch mechanism play an important role in the paper loading operation as described below.

1. ASF home position detection function

The change lever and the clutch mechanism are used to detect the ASF home position.

The counterclockwise rotation of the PF motor brings the change lever to engage with the clutch mechanism. The ASF home position is detected by the engagement of the change lever at the beginning of the paper loading operation. At this time, paper is not fed to the PF roller because the PF motor drive force is not yet transmitted to the LD roller shaft.

2. Paper loading function

When the change lever is disengaged from the clutch mechanism by the counterclockwise rotation of the PF motor pinion gear, the printer changes to the paper loading state from the ASF home position detection state. The PF motor drive force is transmitted to the LD roller, and paper is fed from the ASF unit.

The rotation of the two cams on the LD roller feeds paper into the printer.

- Larger cam: moves the hopper
- Smaller cam: moves the paper back lever

When the first sheet of paper has been fed, the second sheet is returned to the standby position by the hopper and the paper back lever, which are moved by the cams.

The following sections explain the paper loading sequence and operations of each component.

#### STEP1: ASF HOME POSITION

The counterclockwise rotation of the PF motor pinion gear (as seen from the left of the printer) causes the change lever to push down on the clutch lever, and the clutch lock tab is disengaged from the clutch gear as shown in Figure 2-9. This cuts the PF motor drive transmission to the LD roller shaft, and the shaft does not move at all. At the same time, the hopper is pushed down by the two cams on the LD roller shaft, and the paper back lever is set at the position to prevent paper from being fed. The “ASF home position” indicates all of the above statuses.

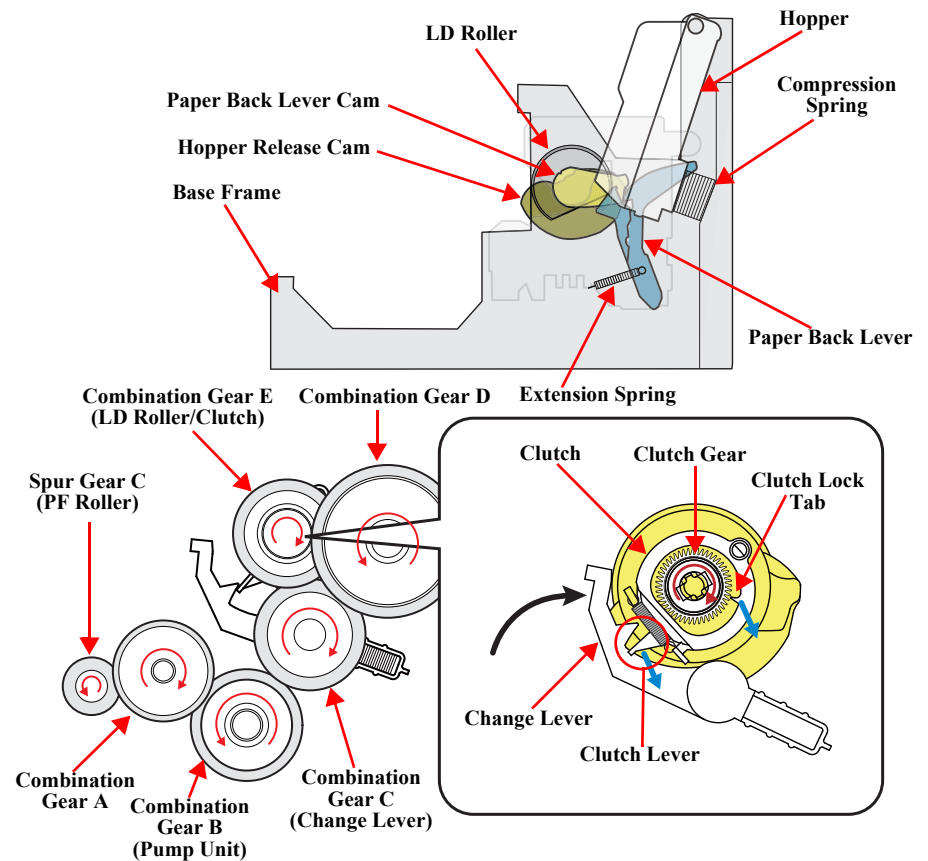


Figure 2-9. ASF Home Position



**STEP2: RELEASING CLUTCH LEVER TO DRIVE LD ROLLER**

When the PF motor pinion gear starts clockwise rotation (as seen from the left side), the change lever is moved toward the front of the printer to release the clutch lever. This causes the clutch to engage with the gear by being pulled by the extension spring. The clutch gear engages with the clutch lock tab and the PF motor drive force is now can be transmitted to the LD roller shaft.

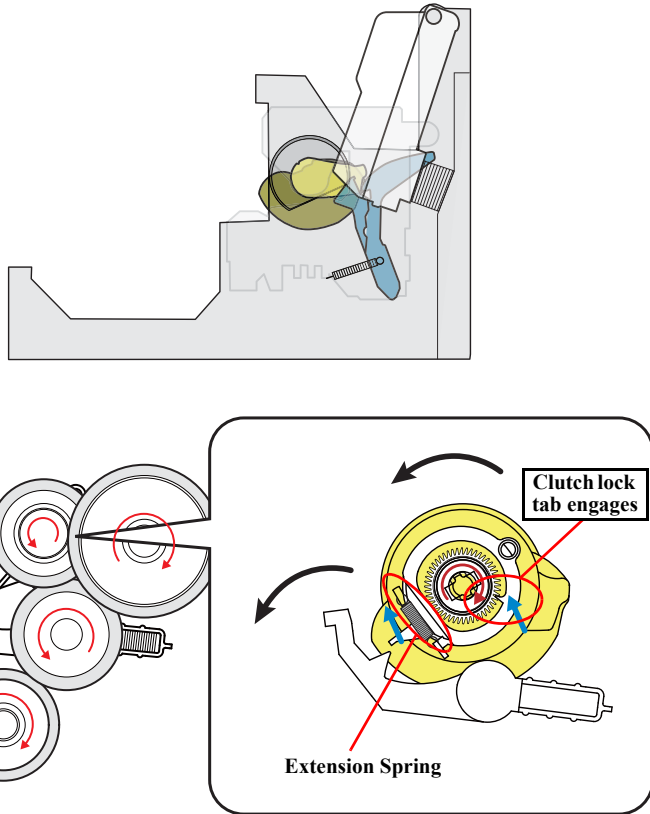


Figure 2-10. Releasing Clutch Lever

**STEP3: FEEDING PAPER FROM ASF**

After the engagement of the clutch, the PF motor pinion gear starts counterclockwise rotation (as seen from the left side) and the drive force is transmitted to the LD roller shaft via the clutch lock tab and the clutch gear. When the LD roller starts to rotate, the paper back lever is returned to its standby position, and the hopper is released from the cams by being pushed by the spring. This causes paper to be caught between the hopper and the LD roller, and the further rotation of the LD roller feeds the paper into the printer.

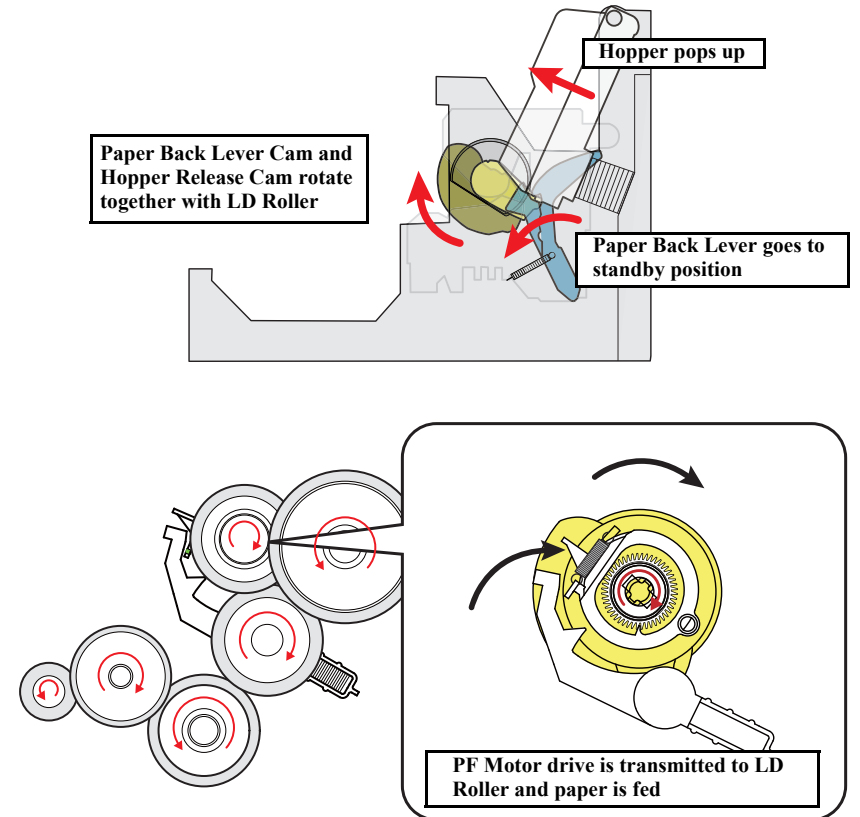
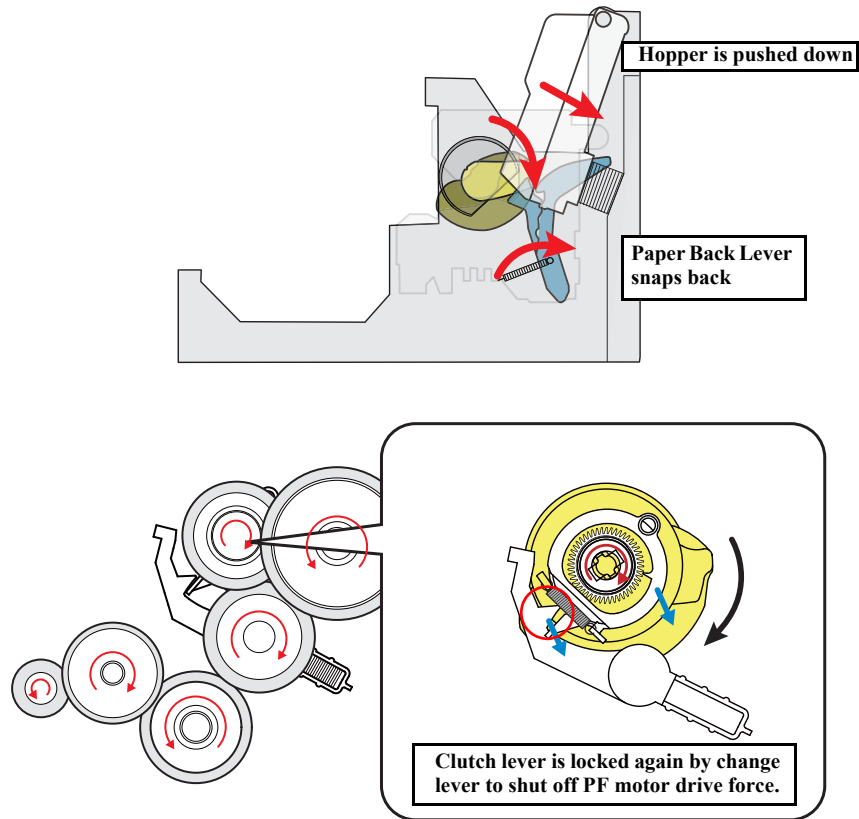


Figure 2-11. Feeding Paper from ASF

**STEP4: ENDING PAPER LOADING OPERATION**

Continuous counterclockwise rotation of the LD roller (as seen from the left side) feeds paper to the PF roller. The LD roller rotation causes the hopper release cam and the paper back lever cam to push down the hopper and the paper back lever respectively. The paper back lever returns paper to the standby position to prevent multiple sheets of paper from being fed at once.

When the LD roller and the clutch reach the ASF home position shown in “Step1” on the previous page, the clutch lever is locked again by the change lever. This causes the PF motor drive force not to be transmitted to the paper loading mechanism and to be transmitted only to the paper feeding mechanism.



**Figure 2-12. Ending Paper Loading Operation**

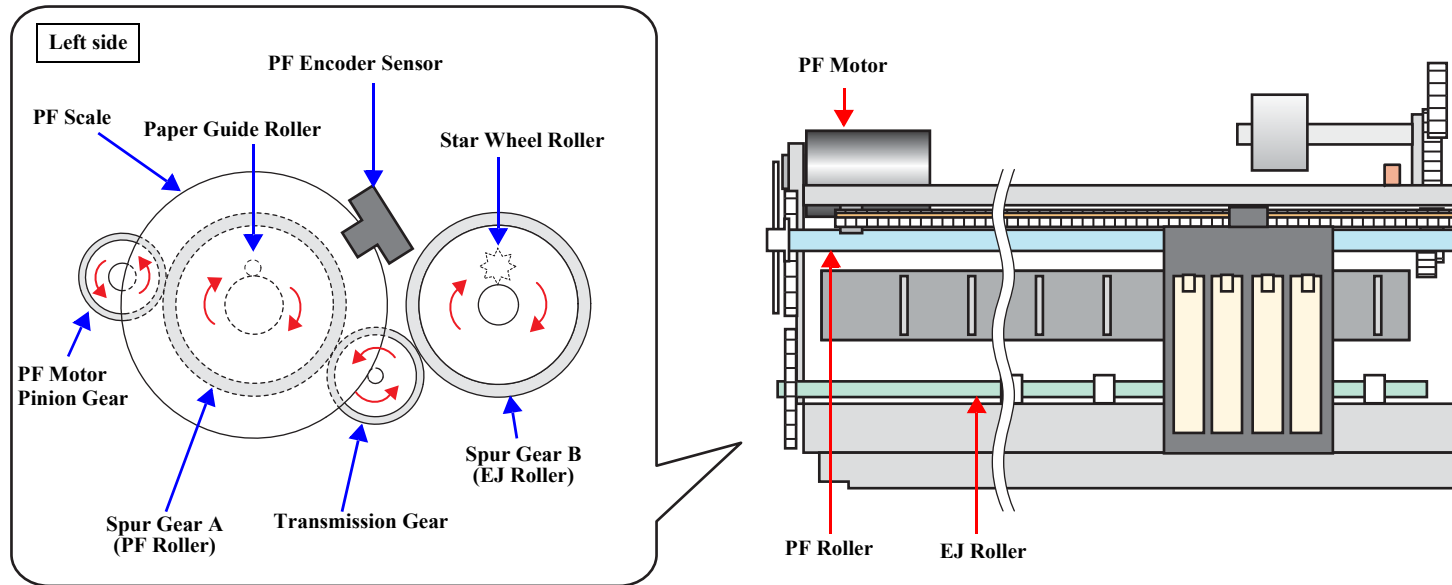
### 2.1.5.2 Paper Feed Mechanism

The major components of the paper feed mechanism are the PF motor, PF roller, EJ (paper eject) roller, PE sensor, PF encoder sensor, and PF scale. The sheet of paper fed from the ASF unit is nipped between two rollers to be transported during printing and to be ejected.

1. The first two rollers used for feeding the paper are the PF roller and the paper guide roller mounted on the upper paper guide unit. The PF motor drive force is transmitted to the paper guide roller via the PF roller.
2. The next two rollers are the EJ roller and the star wheel roller mounted on the Star Wheel Holder Assy. The PF motor drive force is transmitted to the star wheel roller via the EJ roller.

The figure below shows how the PF motor pinion gear drive force is transmitted to the PF roller, EJ roller, paper guide roller and the star wheel roller.

When the PF motor pinion gear starts counterclockwise rotation (as seen from the left side), the sheet of paper fed from the ASF unit to the PF roller is transported and ejected from the printer by the PF roller/paper guide roller combination and the EJ roller/star wheel roller combination.



PF Motor Drive Transmission Path (as seen from the left side of the printer)

- PF motor pinion gear (CCW) → Spur gear A (PF roller) (CW) → Transmission gear (CCW) → Spur gear B (EJ roller) (CW)

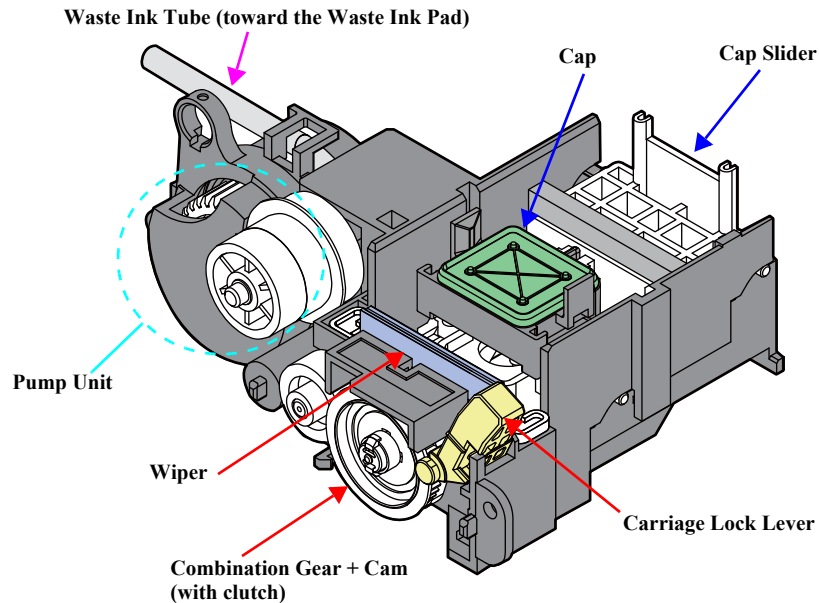
Figure 2-13. Paper Feed Mechanism

## 2.1.6 Ink System Mechanism

The ink system mechanism includes the cap mechanism and the pump mechanism. And the capping mechanism includes the carriage lock mechanism and the wiping mechanism. The table below describes the function of each mechanism.

**Table 2-4. Function of Each Mechanism in Ink System**

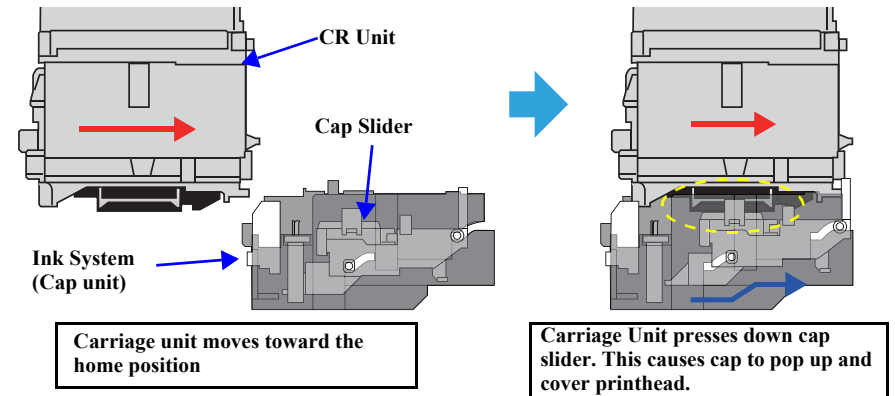
Mechanism	Function
Capping mechanism	Covers the printhead with the cap to prevent ink evaporation when the printer is in standby mode or when the printer is off.
Wiping mechanism	Wipes dust or ink stain off the printhead nozzle surface.
Pump mechanism	Drains ink from the ink cartridges, ink cavity, and the cap and sends it to the waste ink pad.
Carriage lock mechanism	Locks the carriage unit with the carriage lock lever while the unit is in the home position.



**Figure 2-14. Ink System Mechanism**

### 2.1.6.1 Capping Mechanism

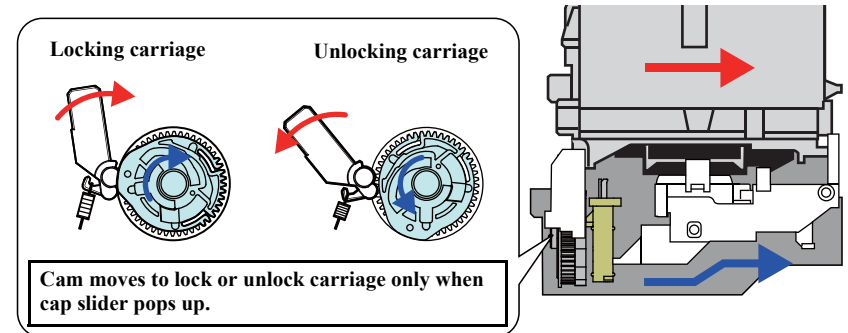
The capping mechanism incorporates the wiping mechanism, however, the two mechanisms operate independently. Capping the printhead is performed by the carriage movement as the conventional models (such as Stylus CX4900/CX5000/CX6000) do.



**Figure 2-15. Capping Mechanism**

### 2.1.6.2 Carriage Lock Mechanism

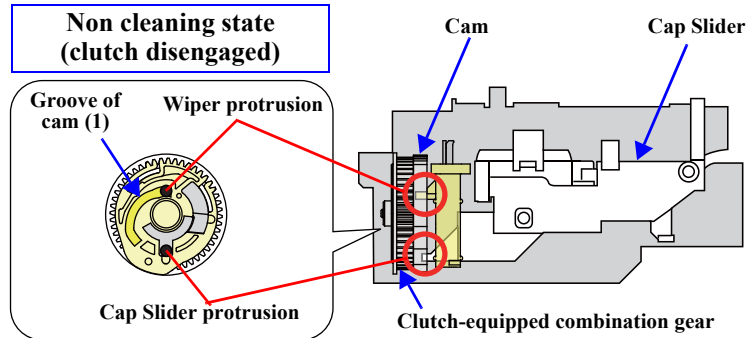
The carriage lock mechanism is activated by the capping operation. Locking or unlocking the carriage is performed by the PF motor drive force that is transmitted via the cam of the clutch-equipped combination gear. (See *"Wiping Mechanism (p53)"* for more explanation about the cap slider and the cam operations)



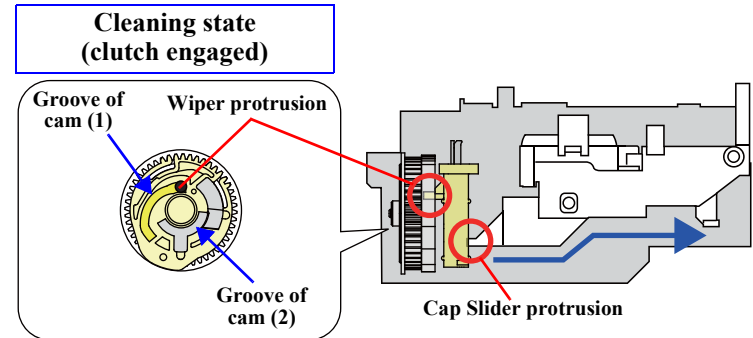
**Figure 2-16. Carriage Lock Mechanism**

### 2.1.6.3 Wiping Mechanism

The wiping mechanism is activated by the capping operation. The mechanism moves the wiper into- and out-of position for cleaning the head using the PF motor drive force that is transmitted via the cam of the clutch-equipped combination gear.

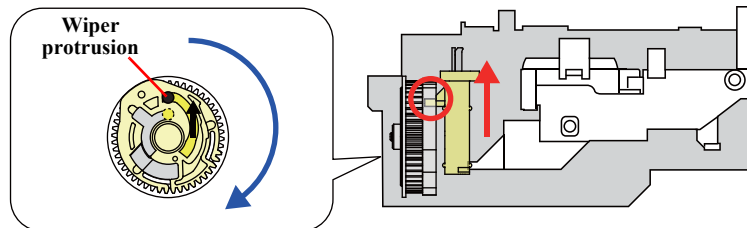


In the non-cleaning state, the cap slider protrusion secures the cam and the clutch of the combination gear is disengaged. Therefore, the PF motor drive force is not transmitted to the cam.



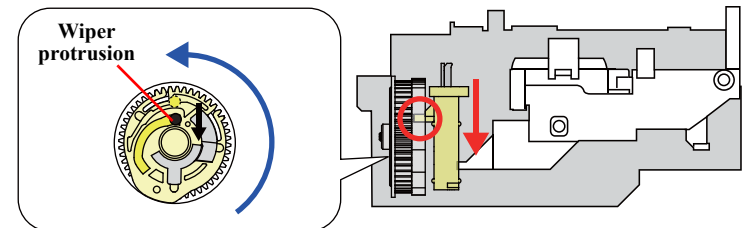
When the cap slider pops up, its protrusion is disengaged from the groove of cam (2). Therefore, the clutch is engaged causing the cam to rotate together with the combination gear.

#### PF motor CW rotation: Moves the Wiper Upward

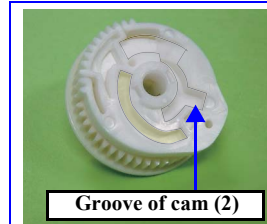


The clockwise rotation of the PF motor rotates the cam in clockwise direction to move the wiper upward to clean the head.

#### PF motor CCW rotation: Moves the Wiper Downward



The counterclockwise rotation of the PF motor rotates the cam in counterclockwise direction to move the wiper downward, which is out-of-position for cleaning.



Groove (2) of the cam is designed so that the cap slider protrusion cannot be set into the groove unless the wiper is moved downward. This prevents the slider protrusion from being engaged with the groove when the slider is moved downward without the wiper moved downward.

Figure 2-17. Wiping Mechanism

### 2.1.6.4 Pump Unit Mechanism

The PF motor drives the pump unit mechanism as well as the paper loading/feed mechanisms. The motor drive force is always transmitted to the pump unit. (It is also transmitted to the LD roller via the clutch mechanism and the change lever.)

The rotational direction of the PF motor changes the pump unit operations as shown in the following table.

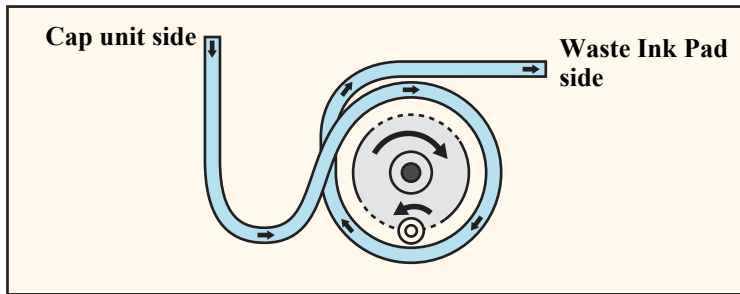
**Table 2-5. PF Motor Rotational Direction & Pump Unit Operation**

Rotational Direction*	Function
Clockwise	• Releases the pump
Counterclockwise	• Draws (suctions) ink

Note "\*": The rotational direction as seen from the right side of the printer.

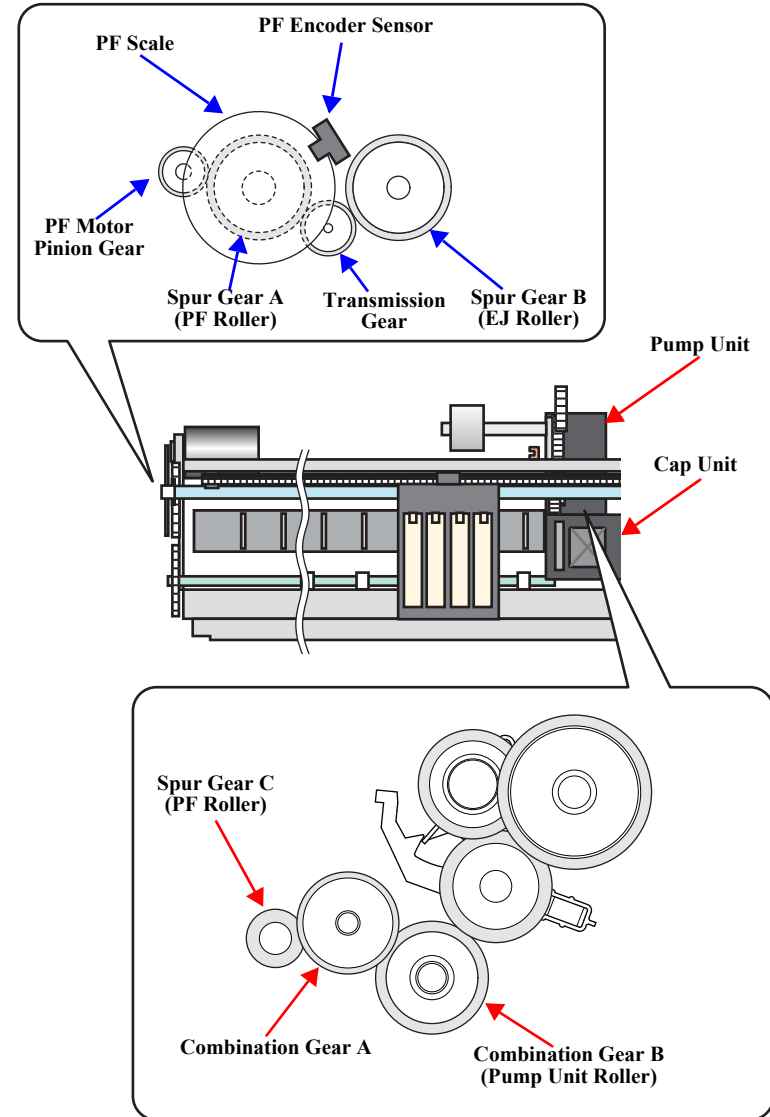
- Ink drawing operation  
The pump unit draws ink out of the ink cartridges and ink cavity, and sends it to the waste ink pad by means of a pressure to the ink tube applied by the pump unit roller.

The following figure illustrates an overview of the pump unit mechanism operation.



Note : The PF motor rotational direction is as seen from the right side of the printer.

**Figure 2-18. Pump Mechanism**



**Figure 2-19. PF Motor Drive Transmission to Pump Unit**

## 2.1.7 Ink Sequence

### □ Initial ink charge

When the printer power is turned On first time after purchase, the initial ink charge is automatically carried out to fill the ink cavity in the printhead with ink. The initial ink charge flag in the EEPROM is cleared when the initial charge is completed successfully. EPSON Stylus CX7300/CX7400/DX7400/NX200/TX200/TX203/TX209/SX200/SX205 and Stylus CX8300/CX8400/DX8400/NX400/TX400/TX405/TX409/SX400/SX405 requires about 120 seconds at maximum for the initial ink charge. If the power is turned Off during the process, the printer automatically runs a CL3 at the next power-on.

### □ Manual Cleaning

EPSON Stylus CX7300/CX7400/DX7400/NX200/TX200/TX203/TX209/SX200/SX205 and Stylus CX8300/CX8400/DX8400/NX400/TX400/TX405/TX409/SX400/SX405 offers three types of manual head cleaning (CL1, CL2, and CL3) that can be run from the control panel. They delete air bubbles in ink, clear nozzle clogging, or to eject foreign materials.

CL1, CL2, and CL3 are performed in that order when the cumulative print time has not reached 9 minutes regardless of the number of print paths counted since the last CL. When 9 minutes has reached or exceeded, only CL1 is executed.

In the case that any of the ink cartridges has almost run out or completely run out of ink, the LED flashes or light and the manual cleaning is disabled.

### □ Timer Cleaning

Like the previous printers, this printer does not have lithium battery which is used for the backup power source for Timer IC. So, this printer manages the printer off period or cleaning cycle by using the following method.

The printer driver sends the timer command (time data) to the printer before printing. The command is generated based on the PC's timer and it consists of year, month, date, hour, minute and second. As soon as the printer receives the timer command, the printer stores the command in the EEPROM and compares it with the latest CL time which has been stored in the EEPROM. When the time difference exceeds the predetermined time period, the printer automatically runs the timer cleaning and stores the date and time of the cleaning in the EEPROM.

### □ Flushing

The following two types of flushing is carried out automatically.

#### ■ Pre-printing flushing

Reduces viscosity of ink inside the nozzles before starting printing.

#### ■ Periodic flushing

Reduces viscosity of ink inside the nozzles during printing.

## 2.2 Scanner Mechanism

The major components of the scanner mechanism of EPSON Stylus CX7300/CX7400/DX7400/NX200/TX200/TX203/TX209/SX200/SX205 and Stylus CX8300/CX8400/DX8400/NX400/TX400/TX405/TX409/SX400/SX405 are the scanner carriage unit and the scanner motor.

### 2.2.1 Scanner Carriage Mechanism

#### 2.2.1.1 Scanner Carriage Unit Overview

The Scanner Carriage Unit is constructed of a CIS Board (including linear CCD), Rod Lens Array, LED (light source), etc.

□ CIS Board

CIS Board contains the sensing elements that are placed across the entire width of an original. The sensing elements, which does not install a color filter, read an original through the Rod Lens Array by turning on red, green, and blue light-emitting diodes (LEDs) alternately. It is not the CIS Board but the Main Board that converts the analog light signal read by the Rod Lens Array into digital signal.

□ Rod Lens Array

A number of rod-shaped lenses, which are arranged on the sensing elements, are also placed across the entire width of an original. These lenses read the light reflected from the original that is produced by the light source (LEDs) and pass the information to the sensing elements. Compared to conventional CCD method, this optical system allows the focal length (distance between sensor and image scanned) to be shallow. Therefore, an original to be scanned should be brought close to the document glass. The optical system, in addition, is 1:1, (there is no optical reduction or enlargement) and this results in a scanner offering the solid performance in terms of accuracy.

□ LED

Three color LEDs (the three colors being red, green, and blue) illuminate the line to be scanned in the document. Unlike cold cathode fluorescent lamp used in CCD method, using LEDs requires no warm-up time and allows the CIS to be highly power efficient.

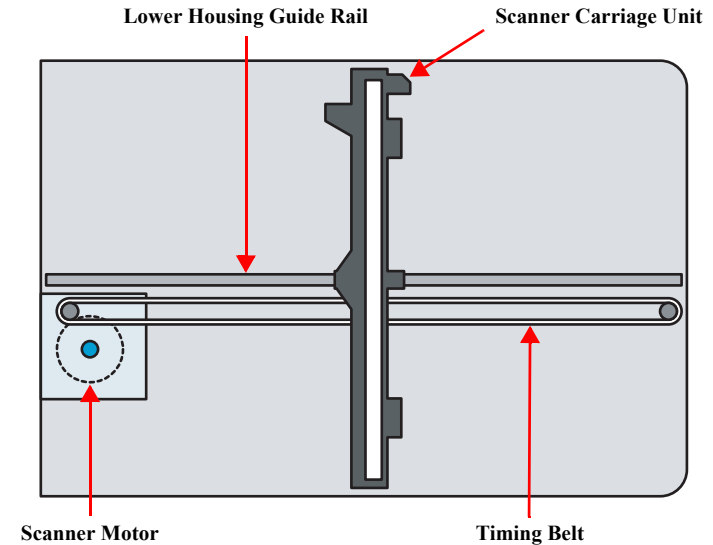


Figure 2-20. Scanner Mechanism

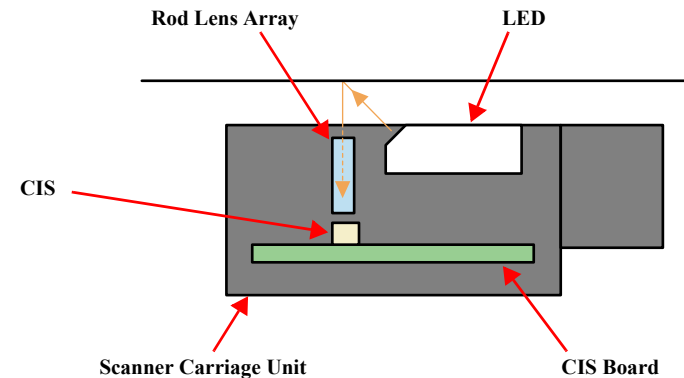


Figure 2-21. Scanning image



### 2.2.1.2 Scanner Carriage Unit Movement Overview

Scanning image is performed in the main scan direction (=1 line) by the CIS board and in the sub-scan direction (=several lines) combined with Scanner Carriage Unit movement. (refer to the figure below) The CIS board can scan 1 line in main scan direction (parallel to the Scanner Carriage Unit) by one time. When scanning next lines after the second line in sub-scan direction, CR driving moves the Scanner Carriage Unit, and scan the other lines. The scanned data is sent to the control board. The scanned data for “n” lines and “n-1” line are processed consecutively.

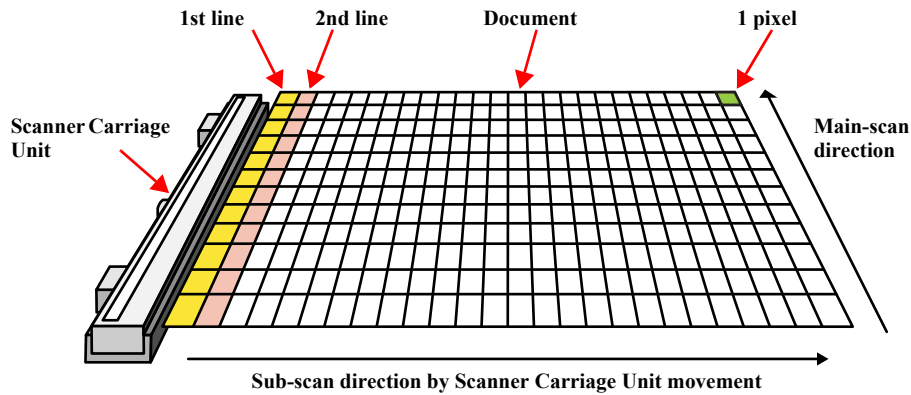


Figure 2-22. Scanner Carriage Unit movement

Drive of the Scanner Motor is transferred to the Scanner Carriage Unit by the Scanner Timing Belt. The Scanner Carriage Unit slides in the secondary scanning direction. The Scanner Motor uses a stepping motor and drives using open loop control.

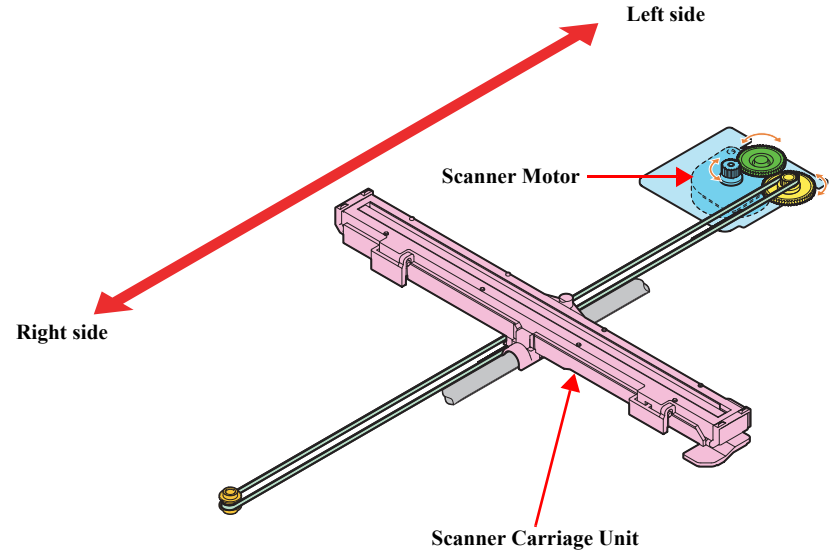


Figure 2-23. Scanner Carriage Unit Mechanism

CHAPTER

3

# TROUBLESHOOTING

### 3.1 Overview

This chapter describes how to solve problems.



- Be careful to avoid electric shocks when checking the electrical circuit boards (C690 MAIN and C687 PSE/PSB boards) while the power is turned on.
- Touching an FET, transistor or heat sink with one hand while touching a metal part of the mechanism with the other hand could result in an electric shock, so carefully avoid this.
- After initial filling of ink has been repeated several times, immediate moving or tilting of the printer could result in leaking of ink that has not been completely absorbed by the Waste Ink Pad. When initial filling of ink has been repeated several times, check the ink remaining in the tip of the Waste Ink Tube and the waste ink not absorbed by the Waste Ink Pad before moving the printer.



- Disassembly and reassembly of parts is often required when identifying the causes of problems. The parts should be disassembled and re-assembled correctly while referring to “DISASSEMBLY/ASSEMBLY” (p.90) so that the operation and status of each check item can be correctly verified.
- Some individual part and units may require adjustment once they are removed or replaced. If removing or replacing parts which have specific instructions for adjustment included in “DISASSEMBLY/ASSEMBLY” (p.90), be sure to make these adjustments after repairing the problem location.
- In this chapter, the product names are called as follows:

Notation	Product name
CX7300 series	Stylus CX7300/CX7400/DX7400
TX200 series	Stylus NX200/TX200/TX203/TX209/SX200/SX205
CX8300 series	Stylus CX8300/CX8400/DX8400
TX400 series	Stylus NX400/TX400/TX405/TX409/SX400/SX405

#### 3.1.1 Specified Tools

This printer does not require any specified tools for troubleshooting.

#### 3.1.2 Preliminary Checks

Before starting troubleshooting, be sure to verify that the following conditions are all met:

- The power supply voltage must be within the specification limits. (Measure the voltage at the wall socket.)
- The power code must be free from damage, short circuit or breakage, or miswiring in the power code.
- The printer must be grounded properly.
- The printer should not be located in a place where it can be exposed to too high or low temperature, too high or low humidity, or abrupt temperature change.
- The printer should not be located near waterworks, near humidifiers, near heaters or near flames, in a dusty atmosphere or in a place where the printer can be exposed to blast from an air conditioner.
- The printer should not be located in a place where volatile or inflammable gases are produced.
- The printer should not be located in a place where it can be exposed to direct rays of the sun.
- The printer must be placed on a strong and steady level table (without an inclination larger than five degrees).
- Any vibrating equipment must not be placed on or under the printer.
- The paper used must conform to the specification.
- There is no error in handling of the printer.
- Check the inside of the printer, and remove foreign matters if any, such as paper clips, staples, bits of paper, paper dust or toner.
- Clean the inside of the printer and the rubber rolls.

## 3.2 Troubleshooting

### 3.2.1 Motor and Sensor Troubleshooting

□ Motors

The resistance values for the CR motor and the PF motor are given below, however, the values cannot be used to check the motors status since they are DC motor and the resistance between the electric poles varies. Visually check the motors for abnormal operation and if it is hard to judge, replace the motor.

**Table 3-1. Motor resistance and check point**

Motor	Motor Type	Drive Voltage	Resistance
CR motor	DC motor with bras	DC 42V ± 5%	28.8Ω ± 10%
PF motor			21.2Ω ± 10%
Scanner motor	2-phase, 96-pole PM stepping motor		43.0Ω ± 10%*1 or 48.0Ω ± 10%*2

Note \*1: Manufactured by Oki Electric Industry Co., Ltd.  
 Manufactured by MITSUMI ELECTRIC CO., LTD.

□ Sensors

**Table 3-2. Sensor check point**

Sensor name	Check point	Signal level	Switch mode
PE Sensor	CN24/Pin 1 and 2	Less than 0.4V	Off: No paper
		More than 2.4V	On: Detect the paper

### 3.3 Error Indications and Fault Occurrence Causes

This section describes how the printer indicates an error / warning status with LEDs / LCD, or on the screen of the printer driver when a problem arises during various operations; power-on sequence, paper feeding, ink drawing, printing, and so on.

#### 3.3.1 Error Indication Method

You can handle most of the troubles with the messages/instructions shown on the LCD panel or the window of “EPSON Status Monitor 3” (when connected to the PC).

- For CX8300/TX400 series

Error messages are displayed on the LCD panel.

- See [Figure 1-5. “CX8300/TX400 series Control Panel” \(p.19\)](#).

- For CX7300/TX200 series

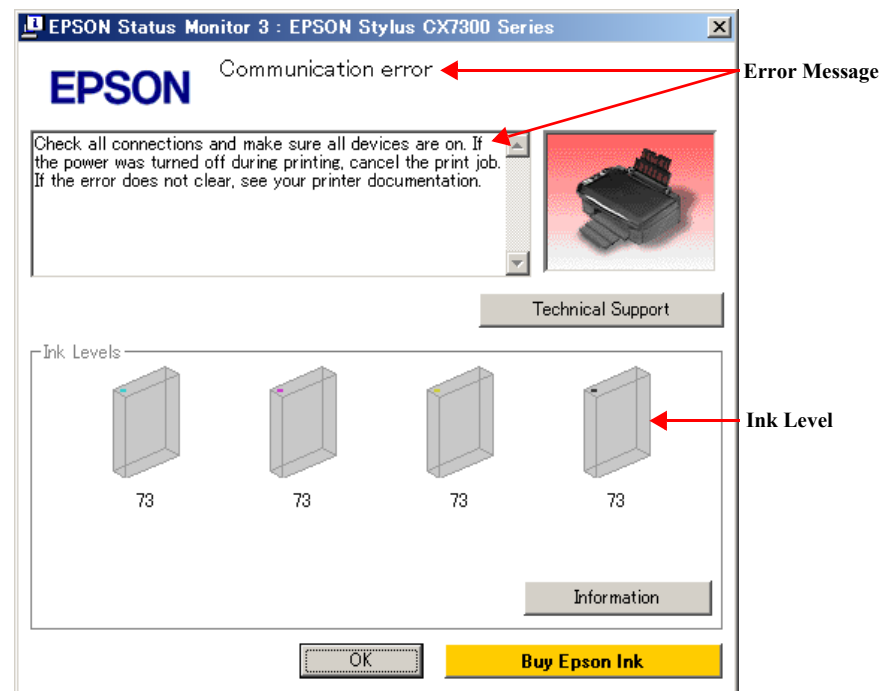
Error status can be checked with the status of the LEDs or the message shown on the windows of “EPSON Status Monitor 3”.

- See [Figure 1-6. “CX7300/TX200 series Control Panel” \(p.20\)](#).

**Table 3-3. LEDs Status (CX7300/TX200 series)**

LED Status	Meaning
--	No change
ON	Lights normally
Blink 1	Flashes: 1.25sec On + 1.25sec Off
Blink 2	Flashes: 0.5sec On + 0.5sec Off + 0.5sec On + 1.0sec Off
Blink 3	Flashes: 0.5sec On + 0.5sec Off

- Message box on the window of “EPSON Status Monitor 3”



**Figure 3-1. Error Indication on EPSON Status Monitor 3**

**Table 3-4. Error Indications and Fault Occurrence Causes**

Error Name	CX8300/TX400 series	CX7300/TX200 series				STM3 Message	Error Cause	Reference
	LCD Message	LED Indications						
		Power	Error	Ink	Paper 1/2			
Fatal error (scanner)	A scanner error has occurred. See your documentation	Blink 3	Blink 3	Blink 3	Blink 3 (selected side LED)	-	RAM trouble occurs. System trouble occurs.	Table 3-5. (p65)
Fatal error (printer mechanism)	A printer error has occurred. Turn off the printer, then press On button to turn on. See your documentation.	Blink 1	Blink 1	Blink 1	Blink 1 (selected side LED)	Delete all print jobs and turn the printer off. Remove any foreign objects from inside the printer. After a few minutes, turn the printer back on.	Mechanical trouble occurs.	
Maintenance error (waste ink overflow)	Waste ink pad in the printer is saturated. Contact your dealer to replace it.	Blink 1	ON	ON	Blink 1 (selected side LED)	Parts inside your printer are near the end of their service life. See your printer documentation.	The waste ink counter exceeds to capacity.	Table 3-6. (p71)
Paper jam error	Paper jam. Open the scanner unit and remove the paper. Press the Start button to eject the paper inside. See your documentation.	--	Blink 1	OFF	--	Click the How to button for instructions on removing jammed paper.	Paper stays in the paper path after paper ejection.	Table 3-7. (p71)
CSIC Error Incorrect I/C	Cannot recognize ink cartridges. Make sure ink cartridges are installed correctly.	--	OFF	ON	--	Black: XXXX* <sup>1</sup> Color: XXXX* <sup>1</sup> ..... Epson recommends the genuine Epson cartridges listed above. Click the How to button for ink cartridge installation instructions.	Ink is out in some I/C or no I/C is set or incorrect I/C is set.	Table 3-8. (p74)
Ink cartridge cover open error	Ink cartridge cover is open. Open the scanner unit and close the ink cartridge cover.							
Replace Ink Cartridge	Press the OK button to replace the cartridges.							
Paper out error	Paper out. Load paper and press the Start button.	--	ON	OFF	--	Reload the paper, then press the Start button on the printer or click the Continue button if it appears on the screen. To cancel all print jobs, click the Cancel button.	Failure to load paper to print.	Table 3-9. (p75)

Table 3-4. Error Indications and Fault Occurrence Causes

Error Name	CX8300/TX400 series	CX7300/TX200 series				STM3 Message	Error Cause	Reference
	LCD Message	LED Indications						
		Power	Error	Ink	Paper 1/2			
Double feed error	Multi-page feed error. Remove and reload the paper, then press the Start button.	--	ON	OFF	--	A page has not been printed, multiple pages have been fed into the printer at once, or the wrong paper size has been fed into the printer. Remove and reload the paper. Press the Start button if necessary.	Double feed during double sided printing.	Table 3-17. (p79)
Memory card error	Cannot recognize the memory card or disk.	--	Blink 2	OFF	OFF	--	That memory card is not available with this unit. Or no image can be found in that card when memory card print is started.	Table 3-12. (p77)
Index sheet error 1 (No index sheet)	There is no index sheet or it is not positioned correctly. Check it and try again.	--	Blink 2	OFF	--	--	The direction of order sheet is opposite. No index sheet is recognized correctly.	Table 3-13. (p78)
Index sheet error 2 (Incorrect marking)	Photos are not selected or the ovals are marked incorrectly. Please correct and try again.	--	Blink 2	OFF	--	--	When there is a mismatch in the content of the order sheet (When it is not marked though the selection is necessary.)	Table 3-14. (p78)
Index sheet error 3 (Incorrect card)	The contents of the memory card have changed. Print a new index sheet and try again.	--	Blink 2	OFF	--	--	The different card or updated card is found for that sheet.	Table 3-15. (p78)
DSC Direct error	Cannot recognize the device.	--	Blink 2	OFF	--	--	A device not supported is connected to the port for the connection of external memory devices. The DSC demands the current larger than mechanical limit.	Table 3-11. (p77)

Table 3-4. Error Indications and Fault Occurrence Causes

Error Name	CX8300/TX400 series	CX7300/TX200 series				STM3 Message	Error Cause	Reference
	LCD Message	LED Indications						
		Power	Error	Ink	Paper 1/2			
Head cleaning (Ink low error)	Replace ink cartridge before cleaning Printhead.			Blink 1		Black: XXXX*1 Color: XXXX*1 ..... You may continue printing, or click the How to button to change the ink cartridge now.	Head cleaning was attempted in the Ink low status.	Table 3-10. (p77)
Pre-scanning error (photo) (CX8300/TX400 series only)	No photos could be recognized. Make sure the photos are positioned correctly. For details, see your manual.	--	--	--	--	--	Photos cannot be recognized.	Table 3-16. (p79)
Communication error	--	--	--	--	--	Check all connections and make sure all devices are on. If the power was turned off during printing, cancel the print job. If the error does not clear, see your printer documentation.	The printer cannot communicate with the PC properly.	Table 3-18. (p80)

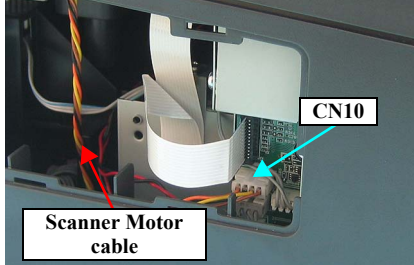
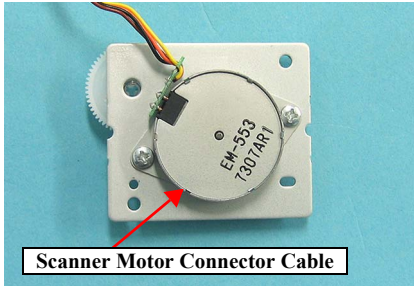
Note \*1: The “XXXX” represents the part number of the Ink Cartridge.



### 3.3.2 Troubleshooting by Error Message

The following tables provide troubleshooting procedures. Confirm the error message indicated on the LCD or the STM3 screen on the PC's display, and verify it in the following list and the figures at the end of this chapter for the corresponding troubleshooting remedy. If some parts need to be replaced or repaired, make sure to follow the procedure given in Chapter 4 "Disassembly / Assembly".

**Table 3-5. Check point for Fatal error according to each phenomenon**

Occurrence timing CR position	Detailed phenomenon	Defective unit/part name	Check point	Remedy
<ul style="list-style-type: none"> <li>• Power on</li> <li>• Anywhere</li> </ul>	The Scanner Unit does not initialize when the power is turned on.	Scanner Motor	1. Check if the Scanner Motor cable is connected to CN10 on the Main Board.  	1. Connect the Scanner Motor cable to CN10 on the Main Board.
			2. Check if the coil resistance of the Scanner Motor is about $43\Omega^{*1}$ or $48\Omega^{*2}$ by using the tester ( <i>refer to Table 3-1</i> ).  	2. Replace the Scanner Motor with a new one.
			3. Check if the Scanner Motor Connector Cable is damaged.	3. Replace the Scanner Motor with a new one.

Note \*1: Manufactured by Oki Electric Industry Co., Ltd.  
 \*2: Manufactured by MITSUMI ELECTRIC CO., LTD.

Table 3-5. Check point for Fatal error according to each phenomenon

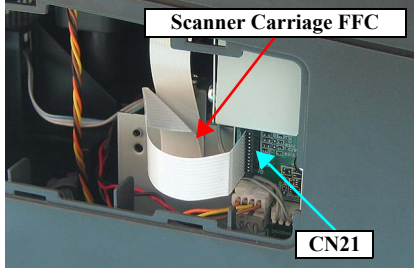
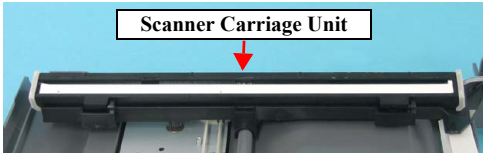
Occurrence timing CR position	Detailed phenomenon	Defective unit/part name	Check point	Remedy
<ul style="list-style-type: none"> <li>• Power on</li> <li>• Anywhere</li> </ul>	The Scanner Unit does not initialize when the power is turned on.	Scanner Carriage FFC	1. Check if the Scanner Carriage FFC is connected to CN21 on the Main Board.  	1. Connect the Scanner Carriage FFC to CN21 on the Main Board.
			2. Check if the Scanner Carriage FFC is damaged.	2. Replace the Scanner Carriage FFC with a new one.
		Scanner Carriage Unit	1. Check if the Scanner Carriage Unit is damaged.  	1. Replace the Scanner Carriage Unit with a new one.

Table 3-5. Check point for Fatal error according to each phenomenon

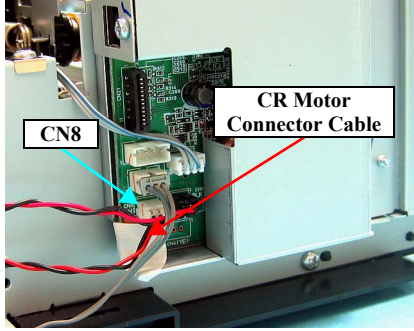
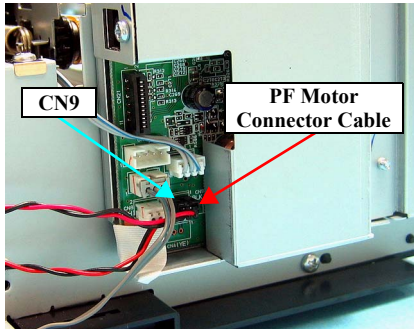
Occurrence timing CR position	Detailed phenomenon	Defective unit/part name	Check point	Remedy
<ul style="list-style-type: none"> <li>• Power on</li> <li>• Anywhere</li> </ul>	<p>When turning on the power, the CR Motor does not operate at all.</p>	<p>CR Motor</p>	<p>1. Check if the CR Motor Connector Cable is connected to CN8 on the Main Board.</p>  <p>2. Check if the CR Motor Connector Cable is not damaged.</p> <p>3. Check if the CR Motor operates.</p>	<p>1. Connect the CR Motor Connector Cable to CN8 on the Main Board.</p> <p>2. Replace the CR Motor with a new one.</p> <p>3. Replace the CR Motor with a new one.</p>
	<p>When turning on the power, the PF Motor does not operate at all</p>	<p>PF Motor</p>	<p>1. Check if the PF Motor Connector Cable is connected to CN9 on the Main Board.</p>  <p>2. Check if the PF Motor Connector Cable is not damaged.</p> <p>3. Check if the PF Motor operates.</p>	<p>1. Connect the PF Motor Connector Cable to CN9 on the Main Board.</p> <p>2. Replace the PF Motor with a new one.</p> <p>3. Replace the PF Motor with a new one.</p>

Table 3-5. Check point for Fatal error according to each phenomenon

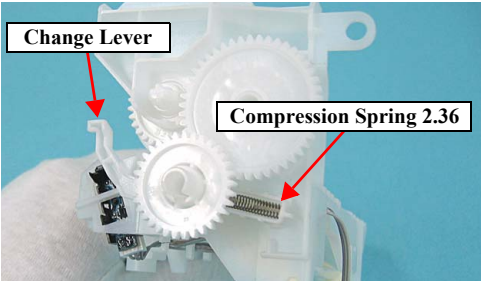
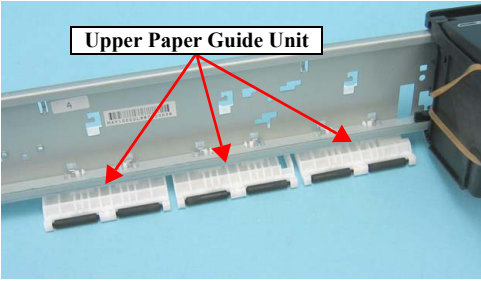
Occurrence timing CR position	Detailed phenomenon	Defective unit/part name	Check point	Remedy
<ul style="list-style-type: none"> <li>• Power on</li> <li>• Anywhere</li> </ul>	When turning on the power, the Carriage Unit collides to the Change Lever located to the front side of the printer.	PF Motor	<ol style="list-style-type: none"> <li>1. Check if the PF Motor Connector Cable is connected to CN9 on the Main Board.</li> <li>2. Check if the PF Motor Connector Cable is not damaged.</li> <li>3. Check if the PF Motor operates.</li> </ol>	<ol style="list-style-type: none"> <li>1. Connect the PF Motor Connector Cable to CN9 on the Main Board.</li> <li>2. Replace the PF Motor with a new one.</li> <li>3. Replace the PF Motor with a new one.</li> </ol>
		ASF Unit	<ol style="list-style-type: none"> <li>1. Check if the Compression Spring 2.36 does not come off in the Change Lever.</li> </ol> 	<ol style="list-style-type: none"> <li>1. Replace the ASF Unit with a new one.</li> </ol>
	The Carriage Unit collides with the Upper Paper Guide Unit when power is turned on.	Upper Paper Guide Unit	<ol style="list-style-type: none"> <li>1. Check if the Paper Guide Upper Unit is correctly assembled.</li> </ol> 	<ol style="list-style-type: none"> <li>1. Reassemble the Upper Paper Guide Unit to the Main Frame correctly.</li> </ol>

Table 3-5. Check point for Fatal error according to each phenomenon

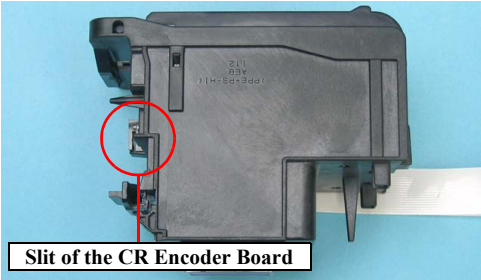
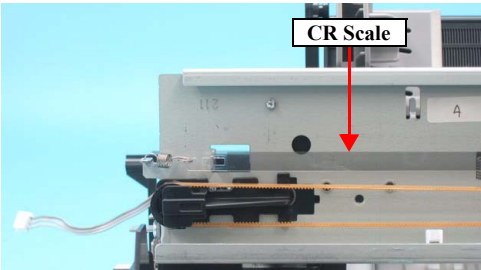
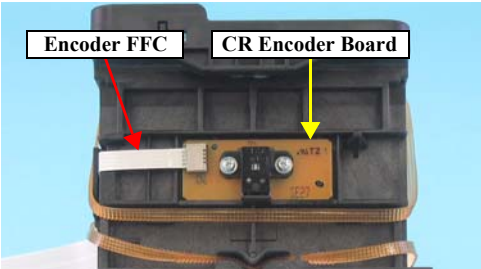
Occurrence timing CR position	Detailed phenomenon	Defective unit/part name	Check point	Remedy
<ul style="list-style-type: none"> <li>• Power on</li> <li>• Anywhere</li> </ul>	When turning on the power, the Carriage Unit collides to the right side of the Main Frame.	CR Scale	1. Check if the CR Scale does not come off or it properly passes through the slit of the CR Encoder Board. 	1. Reassemble the CR Scale correctly. * If the problem is not solved, replace the Main Board with a new one.
			2. Check if the CR Scale is not damaged or contaminated. 	2. Replace the CR Scale with a new one or clean it completely.
		CR Encoder Board	1. Check if the Encoder FFC is connected to the CR Encoder Board. 	1. Connect the Encoder FFC to the CR Encoder Board.
		2. Check if the Encoder FFC is not damaged.	2. Replace the Encoder FFC with a new one.	
		3. Check if the CR Encoder Board is not damaged.	3. Replace the CR Encoder Board with a new one.	

Table 3-5. Check point for Fatal error according to each phenomenon

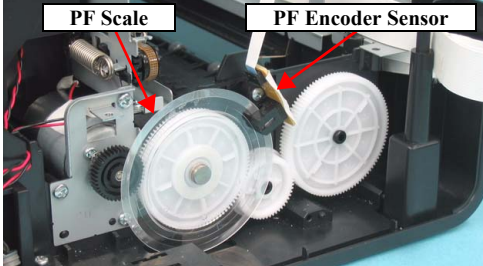
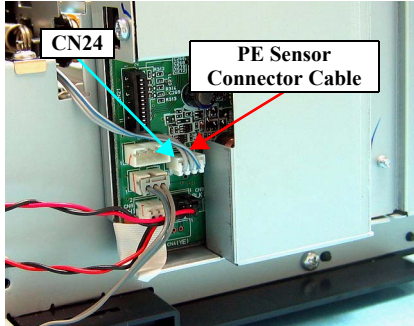
Occurrence timing CR position	Detailed phenomenon	Defective unit/part name	Check point	Remedy
<ul style="list-style-type: none"> <li>Power on</li> <li>Anywhere</li> </ul>	The eject rollers are rotating at high speed when power is turned on. (For about 1 cycle.)	PF Scale/PF Encoder Sensor	1. Check if the PF Scale is not damaged or contaminated.  The diagram shows the internal mechanism of the printer's paper feed system. A white gear labeled 'PF Scale' is positioned next to a 'PF Encoder Sensor'. Red arrows point to the sensor and the scale.	1. Replace the PF Scale with a new one.
			2. Check if the PF Encoder Sensor is not damaged.	2. Replace the PF Encoder Sensor with a new one.
<ul style="list-style-type: none"> <li>Operation</li> <li>Anywhere</li> </ul>	The Scanner Carriage Unit does not operate.	Lower Scanner Housing	1. Check if the grease is applied enough on the surface of the Guide Rail of the Lower Scanner Housing.	1. Apply the grease on the surface of the Guide Rail of the Lower Scanner Housing after wiping the old grease with a dry, soft cloth. (Refer to Chapter 6 “MAINTENANCE” (p.151))
	A paper feeding sequence failed to feed the paper, but a paper ejection sequence is performed.	ASF Unit	1. Check if the PE Sensor Connector Cable is connected to CN24 on the Main Board.	1. Connect the PE Sensor Connector Cable to CN24 on the Main Board.
			 The diagram shows the internal main board of the printer. A green cable labeled 'PE Sensor Connector Cable' is being plugged into a connector labeled 'CN24'.	2. Reassemble the Scanner Carriage Unit.
2. Check if the PE Sensor Connector Cable is not damaged.	2. Replace the ASF Unit with a new one.			
3. Check if the PE Sensor is not damaged.	3. Replace the ASF Unit with a new one.			

Table 3-6. Check point for the Maintenance request according to each phenomenon

Occurrence timing CR position	Detailed phenomenon	Defective unit/part name	Check point	Remedy
<ul style="list-style-type: none"> <li>• Operation</li> <li>• –</li> </ul>	An error is indicated on the LED and STM or LCD.	Waste Ink Pads	---	1. Change the Waste Ink Pads and initialize the Waste Ink Pad Counter. (Refer to <a href="#">Chapter 5 “ADJUSTMENT” (p.141)</a> )

Table 3-7. Check point for Paper jam error according to each phenomenon

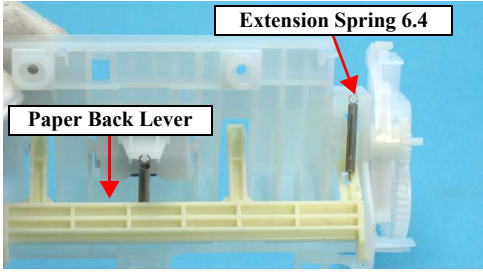
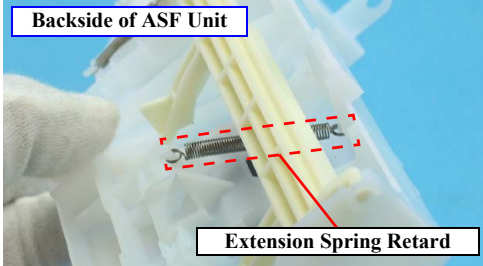
Occurrence timing CR position	Detailed phenomenon	Defective unit/part name	Check point	Remedy
<ul style="list-style-type: none"> <li>• Operation</li> <li>• Outside HP</li> </ul>	A paper feeding sequence failed to feed the paper, but a paper ejection sequence is performed.	ASF Unit	<ol style="list-style-type: none"> <li>1. Check if the ASF Unit is properly installed.</li> <li>2. Check if the Paper Back Lever operates correctly in the paper loading sequence.</li> </ol> 	<ol style="list-style-type: none"> <li>1. Install the ASF Unit properly.</li> <li>2. Set the Extension Spring 6.45 between the ASF Frame and the Paper Back Lever.</li> </ol>
	Paper is being resent during paper feeding operation.	ASF Unit	<ol style="list-style-type: none"> <li>1. Check if the Extension Spring Retard operates correctly in the paper loading sequence.</li> </ol> 	<ol style="list-style-type: none"> <li>1. Set the Extension Spring Retard between the Retard Roller Unit and the ASF Frame.</li> </ol>

Table 3-7. Check point for Paper jam error according to each phenomenon

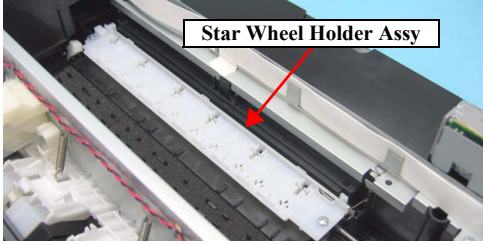
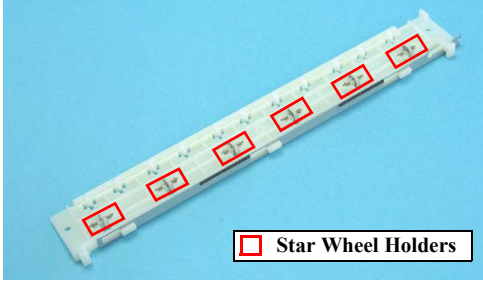
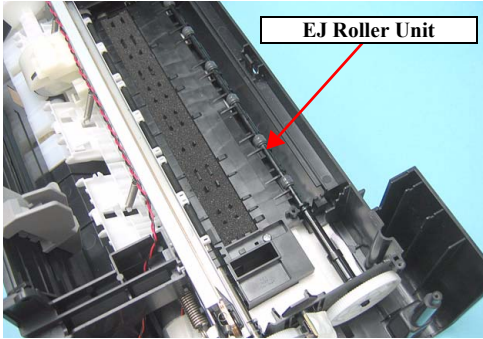
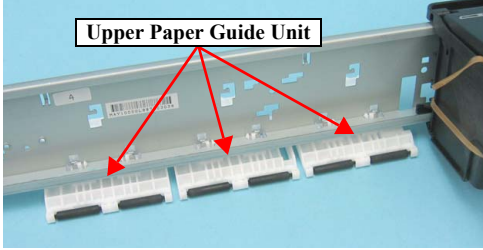
Occurrence timing CR position	Detailed phenomenon	Defective unit/part name	Check point	Remedy
<ul style="list-style-type: none"> <li>• Operation</li> <li>• -</li> </ul>	The top edge of paper does not go through between the EJ Roller Unit and the Star Wheel.	Star Wheel Holder Assy*	1. Check if the Star Wheel Holder Assy is correctly assembled.  	1. Reassemble the Star Wheel Holder Assy correctly.
			2. Check if the Star Wheel Holders does not come off.  	2. Reassemble the Star Wheel Holders correctly.
		EJ Roller Unit*	1. Check if the EJ Roller Unit is correctly assembled.    2. Check if the Spur Gear 51.5 is not damaged.	1. Reassemble the EJ Roller Unit correctly.  2. Replace the EJ Roller Unit with a new one.



Table 3-7. Check point for Paper jam error according to each phenomenon

Occurrence timing CR position	Detailed phenomenon	Defective unit/part name	Check point	Remedy
<ul style="list-style-type: none"> <li>• Operation</li> <li>• —</li> </ul>	The top edge of paper is not loaded to the PF Roller Unit.	Upper Paper Guide Unit*	1. Check if the Upper Paper Guide Unit is correctly assembled. 	1. Reassemble the Upper Paper Guide Unit to the Main Frame correctly.

Note \* : In case that the paper jam error occurs in each operation, the jammed paper contacts the nozzle surface of the Printhead and the Printhead may be damaged.

Table 3-8. Check point for CSIC error / Incorrect Ink Cartridge according to each phenomenon

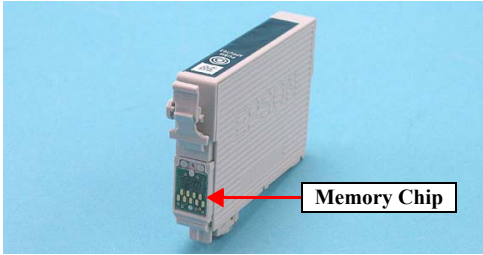
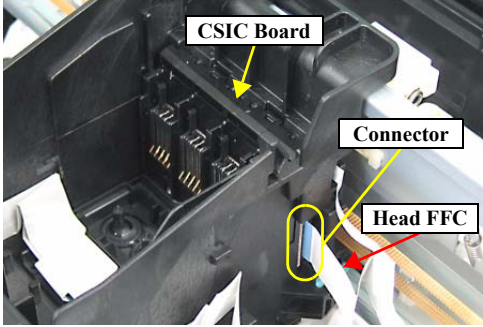
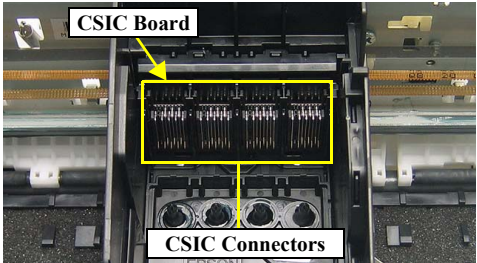
Occurrence timing CR position	Detailed phenomenon	Defective unit/part name	Check point	Remedy
<ul style="list-style-type: none"> <li>• Power on</li> <li>• Inside HP</li> </ul>	After the printer detects that the carriage is at the home position, an error is displayed.	Ink Cartridge	1. Check if Ink Cartridge is properly installed. 2. Check if the Memory Chip is not disconnected or not chipped. <div style="text-align: center; margin-top: 10px;">  <p>Memory Chip</p> </div>	1. Install the Ink Cartridge properly. 2. Replace the Ink Cartridge with a new one.
		CSIC Board	1. Check if the Head FFC is connected to connector on the CSIC Board. <div style="text-align: center; margin-top: 10px;">  <p>CSIC Board Connector Head FFC</p> </div>	1. Connect the Head FFC to connector on the CSIC Board.
		CSIC Connector	2. Check if the CSIC Board is not damaged. 3. Check if the CSIC Connector is not damaged. <div style="text-align: center; margin-top: 10px;">  <p>CSIC Board CSIC Connectors</p> </div>	2. Replace the CSIC Board with a new one. 1. Replace the CSIC Board with a new one.

Table 3-9. Check point for Paper out error according to each phenomenon

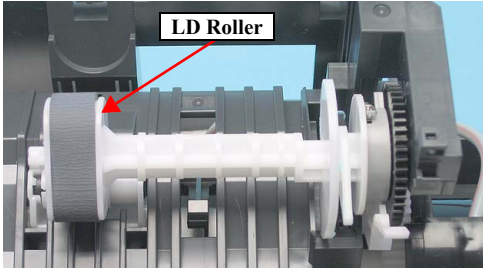
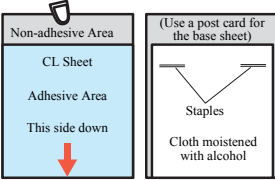
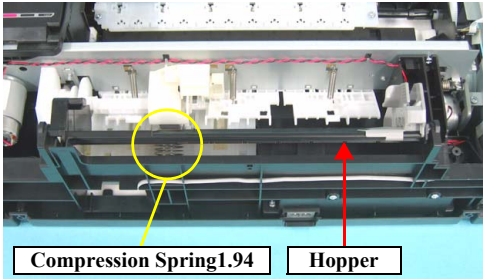
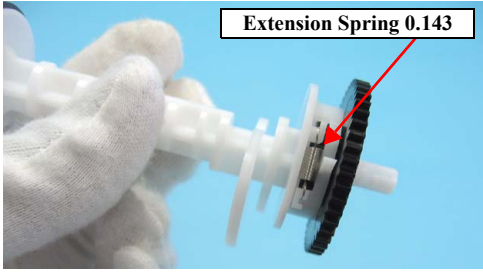
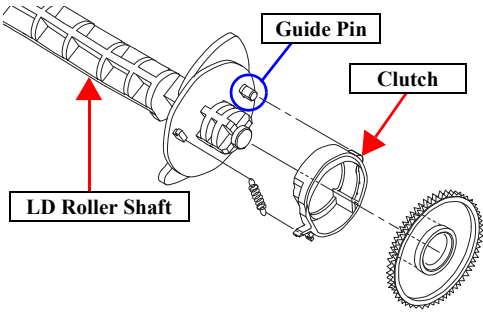
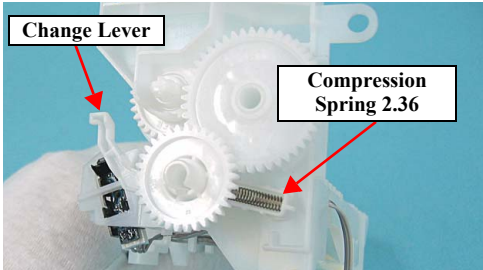
Occurrence timing CR position	Detailed phenomenon	Defective unit/part name	Check point	Remedy
<ul style="list-style-type: none"> <li>• Operation</li> <li>• -</li> </ul>	<p>The LD Roller cannot pick up paper although the LD Roller attempt to rotate correctly.</p>	<p>ASF Unit</p>	<p>1. Check if any paper dust is not adhered to the surface of the LD Roller.</p> 	<p>1. Set a cleaning sheet in the ASF Unit up side down. Then holding the top edge, try to load the paper from the Printer driver. The micro pearl on the LD Roller surface is removed. To remove severe smear, staple a cloth moistened with alcohol to a post card and clean the roller in the same manner.</p>  <p>*If the problem is not solved, replace the ASF unit with new one.</p>
	<p>The Hopper does not operate during the paper loading sequence although the LD Roller rotates to load paper from the ASF Unit.</p>	<p>ASF Unit</p>	<p>1. Check if the Hopper operates correctly in the paper loading sequence.</p> 	<p>1. Reassemble the Compression Spring 1.94 between the Base Frame and the Hopper.</p>

Table 3-9. Check point for Paper out error according to each phenomenon

Occurrence timing CR position	Detailed phenomenon	Defective unit/part name	Check point	Remedy
<ul style="list-style-type: none"> <li>• Operation</li> <li>• -</li> </ul>	The drive of the PF Motor is not transmitted to the LD Roller Shaft.	ASF Unit	1. Check if the Extension Spring 0.143 does not come off in the Clutch mechanism.  	1. Reassemble the Extension Spring 0.143 in the Clutch mechanism.
			2. Check if the positioning hole of the Clutch does not come off from the guide pin of the LD Roller Shaft.  	2. Reassemble the positioning hole of the Clutch on the guide pin of the LD Roller Shaft.
			3. Check if the Clutch tooth is not damaged.	3. Replace the ASF Unit with a new one.
			4. Check if the Clutch is not damaged.	4. Replace the ASF Unit with a new one.
			5. Check if the Compression Spring 2.36 does not come off in the Change Lever.  	5. Replace the ASF Unit with a new one.

**Table 3-9. Check point for Paper out error according to each phenomenon**

Occurrence timing CR position	Detailed phenomenon	Defective unit/part name	Check point	Remedy
<ul style="list-style-type: none"> <li>• Operation</li> <li>• –</li> </ul>	The LD Roller is not set to the ASF home position and paper is always loaded from the ASF Unit during the paper loading sequence.	ASF Unit	1. Check if the tip of the Change Lever is not damaged.	1. Replace the ASF Unit with a new one.

**Table 3-10. Check point for Head Cleaning error (Ink low error) according to each phenomenon**

Occurrence timing CR position	Detailed phenomenon	Defective unit/part name	Check point	Remedy
<ul style="list-style-type: none"> <li>• Operation</li> <li>• –</li> </ul>	Head Cleaning is not carried out.	Ink Cartridge	1. Check if the ink remains in the Ink Cartridge. 2. Check if the Ink Cartridge can be used by installing it to other printer.	1. Replace the Ink Cartridge with a new one. 2. Replace the Ink Cartridge with a new one.

**Table 3-11. Check point for DSC Direct error according to each phenomenon**

Occurrence timing CR position	Detailed phenomenon	Defective unit/part name	Check point	Remedy
<ul style="list-style-type: none"> <li>• Operation</li> <li>• –</li> </ul>	The Digital Camera (as a USB device) cannot be recognized and an error is indicated.	USB Cable	1. Check if the USB Cable is damaged.	1. Replace the USB Cable with a new one.
		Digital Camera	2. Confirm whether the digital camera is compatible with the printer.	2. Replace the digital camera with a compatible one.

**Table 3-12. Check point for Memory Card error according to each phenomenon**

Occurrence timing CR position	Detailed phenomenon	Defective unit/part name	Check point	Remedy
<ul style="list-style-type: none"> <li>• Operation</li> <li>• –</li> </ul>	The Memory Card cannot be recognized and an error is indicated.	Memory Card	1. Check if the Memory Card is compatible with the printer. 2. Check if the Memory Card is damaged. 3. Check if a memory card that the adaptor is needed is inserted into the slot without using the adaptor.	1. Replace the Memory Card with a compatible one. 2. Replace the Memory Card with a new one. 3. Turn off the printer, then remove the card using tweezers or a similar tool.
		Main Board Unit	1. Check if the Memory Card slot pins on the Main Board is bent or broken.	1. Replace the Main Board Unit with a new one.

**Table 3-13. Check point for Index Sheet 1 error (No index Sheet) according to each phenomenon**

Occurrence timing CR position	Detailed phenomenon	Defective unit/part name	Check point	Remedy
<ul style="list-style-type: none"> <li>• Operation</li> <li>• –</li> </ul>	This error occurs when attempting to print using the Index Sheet.	Document Cover	1. Check if the Document Cover is open.	1. Close the Document Cover.
		Index Sheet	1. Check if the Index Sheet is set in the wrong way.	1. Set the Index Sheet correctly.
			2. Check if the Index Sheet's standard position is clean.	2. Reprint the Index Sheet.
Scanner Housing Upper	1. Check if the Document Glass is clean.	1. Clean the Document Glass.		



**Table 3-14. Check point for Index Sheet error 2 (incorrect marking) according to each phenomenon**

Occurrence timing CR position	Detailed phenomenon	Defective unit/part name	Check point	Remedy
<ul style="list-style-type: none"> <li>• Operation</li> <li>• –</li> </ul>	This error occurs when attempting to print using the Index Sheet.	Index Sheet	1. Check if the checkboxes on the Index Sheet are properly marked out.	1. Mark it out properly.

**Table 3-15. Check point for Index Sheet error 3 (incorrect card) according to each phenomenon**

Occurrence timing CR position	Detailed phenomenon	Defective unit/part name	Check point	Remedy
<ul style="list-style-type: none"> <li>• Operation</li> <li>• –</li> </ul>	This error is generated when attempting to print from Index Sheet.	Index Sheet	1. Check if the Index Sheet was printed from the inserted Memory Card.	1. Change the Index Sheet to the one printed from the inserted Memory Card.
		Memory Card	1. Check if the Memory Card storing the Index Sheet data is inserted.	1. Insert Memory Card storing the Index Sheet data.
			2. Check if the Memory Card is damaged.	2. Replace the Memory Card with a new one.

**Table 3-16. Check point for Pre-scanning error (photo) according to each phenomenon (CX8300/TX400 series only)**

Occurrence timing CR position	Detailed phenomenon	Defective unit/part name	Check point	Remedy
<ul style="list-style-type: none"> <li>• Operation</li> <li>• –</li> </ul>	No photos cannot be recognized and an error is indicated.	Photo	1. Check if the photo is set correctly.	1. Set the photo correctly.

**Table 3-17. Check point for Double feed error according to each phenomenon**

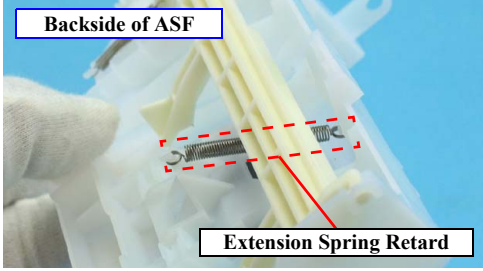
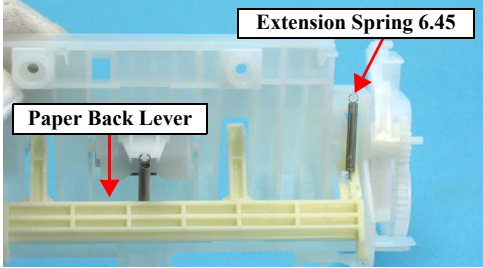
Occurrence timing CR position	Detailed phenomenon	Defective unit/part name	Check point	Remedy
<ul style="list-style-type: none"> <li>• Operation</li> <li>• –</li> </ul>	After both surfaces were printed, the paper was ejected but an error is displayed.	ASF Unit	<p>1. Check if the Extension Spring Retard operates correctly in the paper loading sequence.</p>  <p>2. Check if the Paper Back Lever operates correctly in the paper loading sequence.</p> 	<p>1. Set the Extension Spring Retard between the Retard Roller Unit and the ASF Frame.</p> <p>2. Set the Extension Spring 6.45 between the ASF Frame and the Paper Back Lever.</p>





Table 3-18. Check point for Communication error according to each phenomenon

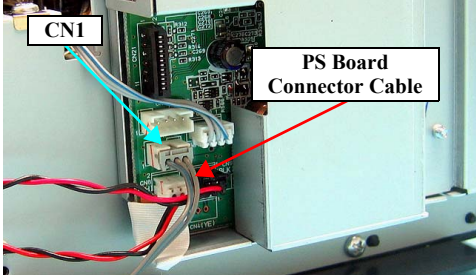
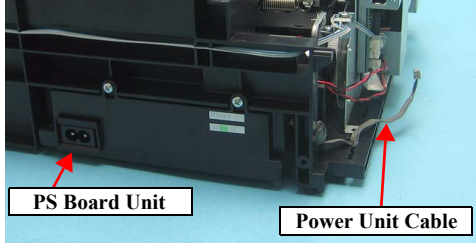
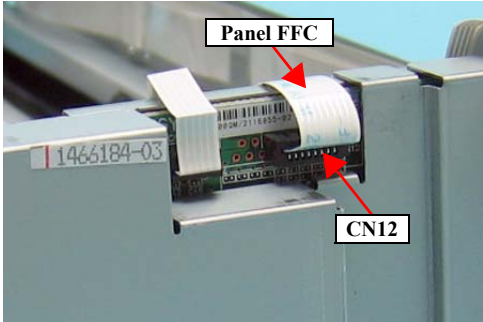
Occurrence timing CR position	Detailed phenomenon	Defective unit/part name	Check point	Remedy
<ul style="list-style-type: none"> <li>• Power on</li> <li>• Anywhere</li> </ul>	<p>When turning on the power, the printer does not operate at all.</p>	<p>PS Board Unit</p>	<p>1. Check if the PS Board Connector Cable is connected to CN1 on the Main Board.</p>  <p>2. Check if the PS Board Connector Cable/PS Board is not damaged.</p> 	<p>1. Connect the PS Board Connector Cable to CN1 on the Main Board.</p> <p>2. Replace the PS Board Unit with new one. * If the problem is not solved, replace the Main Board with new one.</p>

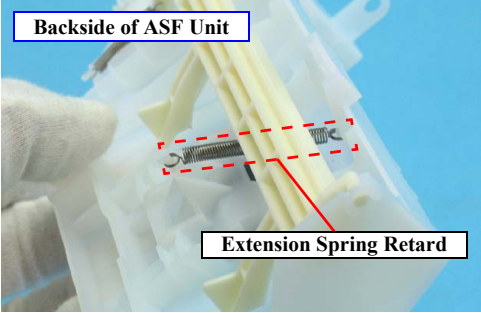
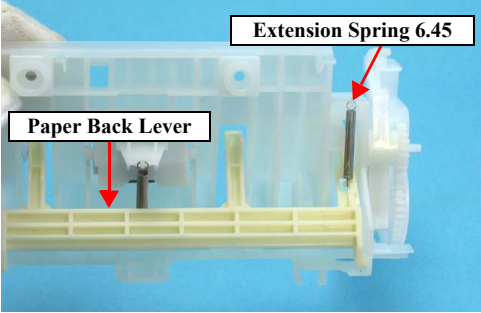
Table 3-18. Check point for Communication error according to each phenomenon

Occurrence timing CR position	Detailed phenomenon	Defective unit/part name	Check point	Remedy
<ul style="list-style-type: none"> <li>• Power on</li> <li>• -</li> </ul>	When turning on the power, the power on sequence is performed correctly. But, when any printer job is sent to the printer, a communication error is indicated with STM3.	USB Cable	1. Check if the USB Cable is connected between the printer and the PC.	1. Connect the USB Cable to the printer and the PC.
		Main Board Unit	1. Check if an correct model name is stored into the address of the EEPROM on the Main Board. 2. Check if the Panel FFC is connected to CN12 on the Main Board. 	1. Use the Adjustment Program to write the correct value to the EEPROM address. 2. Connect the Panel FFC to CN12 on the Main Board.

### 3.3.3 Superficial Phenomenon-Based Troubleshooting

This section explains the fault locations of the error states (print quality and abnormal noise) other than the error states (LED and STM3) in the previous section.

**Table 3-19. Check point for the error that multiple sheets of paper are always loaded without LEDs and STM3**

Occurrence timing CR position	Detailed phenomenon	Defective unit/part name	Check point	Remedy
<ul style="list-style-type: none"> <li>• Operation</li> <li>• –</li> </ul>	<p>The LEDs and STM3 are not indicating error conditions. But, multiple sheets of paper are always loaded from the ASF Unit.</p>	<p>ASF Unit</p>	<ol style="list-style-type: none"> <li>1. Check if the Extension Spring Retard operates correctly in the paper loading sequence.</li> </ol>  <ol style="list-style-type: none"> <li>2. Check if the Paper Back Lever operates correctly in the paper loading sequence.</li> </ol> 	<ol style="list-style-type: none"> <li>1. Set the Extension Spring Retard between the Retard Roller Unit and the ASF Frame.</li> <li>2. Set the Extension Spring 6.45 between the ASF Frame and the Paper Back Lever.</li> </ol>

**Table 3-20. Check point for the abnormal noise**

Occurrence timing CR position	Detailed phenomenon	Defective unit/part name	Check point	Remedy
<ul style="list-style-type: none"> <li>• Anytime</li> <li>• Anywhere</li> </ul>	The abnormal noise occurs at the first power on timing and during each operation although the printing operation is performed.	Carriage Unit	1. Check if the grease on the Carriage Path is sufficient.	1. Wipe off the remaining grease on the Carriage path and lubricate it on its frame.
		ASF Unit	1. Check if the Change Lever moves smoothly.	1. Replace the ASF Unit with a new one.
	The Carriage Unit collides to the Upper Paper Guide Unit during each operation.	Upper Paper Guide Unit	1. Check if the Upper Paper Guide Unit is attached securely. (check if it interferes with the Carriage Unit)	1. Reassemble the Upper Paper Guide to the Main Frame.

**Table 3-21. Check point for the defective scanned image quality**

Print Quality State	Detailed phenomenon	Defective unit/part name	Check point	Remedy
<ul style="list-style-type: none"> <li>• Scanned image is not clear.</li> </ul>	There are dusts or the like on the Document Glass. (white dots appear on the scanned image)	Upper Scanner Housing	1. Check if there is any foreign material on the Document Glass.	1. Remove the foreign material from the Document Glass. (Refer to <a href="#">Chapter 6 “MAINTENANCE” (p.151)</a> .)
	There are dusts or the like on the LED inside the Rod Lens Array. (vertical stripes appear on the scanned image)	Scanner Carriage Unit	1. Check if there is not foreign material on the LED.	1. Remove the foreign material from the Document Glass (blow away the dusts).
	The LED of Scanner Carriage Unit does not light up.	Scanner Carriage Unit	1. Check if the LED lights up.	1. Replace the Scanner Carriage Unit with a new one.

Table 3-22. Check point for the defective printing quality

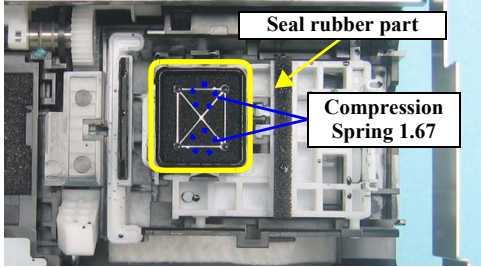
Print Quality State	Detailed phenomenon	Defective unit/part name	Check point	Remedy
• Dot missing and mixed colors	Ink is scarcely ejected to the Cap from the Printhead.	Ink System Unit (Cap Unit)	1. Check if there is not any foreign material/damage around the seal rubber part on the Cap Unit.	1. Remove the foreign material around the seal rubber parts carefully.
				
		2. Check if the Compression Spring 1.67 is correctly mounted on the Cap Unit.	2. Replace the Ink System Unit with a new one.	
	Ink is ejected to the Cap from the Printhead, but the printer does not recover from the error after cleaning or ink change.	Printhead	1. Check if it returns to normal by performing CL operation or replacing the Ink Cartridge.	1. Perform CL operation and the Ink Cartridge replacement specified times. If it doesn't work, change the Printhead with a new one.
			2. Check if the Printhead is not damaged.	2. Replace the Printhead with a new one.
		Cleaner Blade	1. Check if the Cleaner Blade does not have paper dust or bending.	1. Replace the Ink System Unit with a new one.
Main Board		1. Check if the Main Board is not damaged.	1. Replace the Main Board with a new one.	

Table 3-22. Check point for the defective printing quality

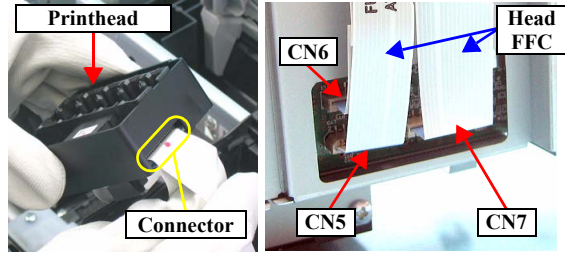
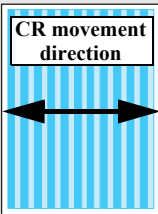
Print Quality State	Detailed phenomenon	Defective unit/part name	Check point	Remedy	
<ul style="list-style-type: none"> <li>White streak / abnormal discharge</li> </ul>	Ink is ejected to the Cap from the Printhead, but printing is not done at all after cleaning or ink change, or abnormal discharge occurs.	Head FFC	1. Check if the Head FFC is securely connected to the Printhead Connectors and the Main Board Connectors (CN5, CN6, and CN7). 	1. Connect the Head FFC to the Printhead and the Main Board Connectors.	
				2. Check if the Head FFC is not damaged.	2. Replace the Head FFC with a new one.
		Printhead	1. Check if it returns to normal by performing CL operation or replacing the Ink Cartridge.	1. Perform CL operation and the Ink Cartridge replacement specified times. If it doesn't work, change the Printhead with a new one.	
		Main Board Unit	1. Check if the Main Board is not damaged.	1. Replace the Main Board Unit with a new one.	
<ul style="list-style-type: none"> <li>White streak / color unevenness occurrence</li> </ul>	Vertical banding appears against the CR movement direction. And, it looks like uneven printing.  [Note] If the problem is not solved, replace the CR Motor with a new one.	Adjustment	1. For printing in the Bi-D mode, check if Bi-D Adjustment has been performed properly.	1. Perform Bi-D Adjustment to correct print start timing in bi-directional printing. (Refer to Chapter 5 "ADJUSTMENT" (p.141).)	
		Printhead	1. Check if the Nozzle Check Pattern is printed properly.	2. Perform Head Cleaning and check the Nozzle Check Pattern. (Refer to Chapter 5 "ADJUSTMENT" (p.141).) If the problem is not solved, replace the Printhead with a new one.	
		Main Frame	1. Check if there is any foreign material on the Carriage path.	1. Remove foreign material from surface of the Carriage path.	
2. Check if the Main Frame is deformed.	2. Replace the Main Frame with a new one.				
			3. Check if the grease is enough on the Carriage path of the Main Frame.	3. After wiping the grease G-71 on the Carriage path with a dry, soft cloth, coat it with grease. (Refer to Chapter 6 "MAINTENANCE" (p.151).)	

Table 3-22. Check point for the defective printing quality

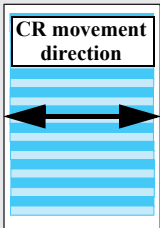
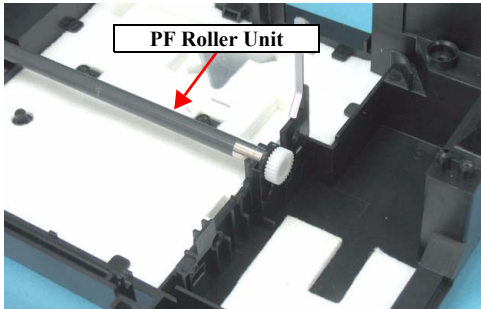
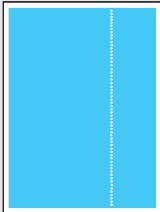
Print Quality State	Detailed phenomenon	Defective unit/part name	Check point	Remedy
• White streak / color unevenness occurrence	Micro banding appears horizontally against the CR movement direction and it appears with the same width.   [Note] If the problem is not solved, replace the PF Motor with a new one.	Printer driver & exclusive paper	1. Check if the suitable paper is used according to the printer driver setting.	1. Use the suitable paper according to the printer driver setting.
		Printhead	1. Check if the Nozzle Check Pattern is printed correctly.	1. Perform the Head Cleaning and check the Nozzle Check Pattern. (Refer to Chapter 5 “ADJUSTMENT” (p.141).) If the problem is not solved, replace the Printhead with a new one.
		PF Roller Unit	1. Check if there is not any foreign material on the surface of the PF Roller Unit.	1. Clean the surface of the PF Roller Unit carefully with the soft cloth.
			2. Check if the PF Roller Unit is not damaged.	2. Replace the PF Roller Unit with a new one.
	The Star wheel mark against the CR movement direction.  	Star Wheel Holder Assy	1. Check if the Star Wheel Holder does not come off.	1. Reassemble the Star Wheel Holder correctly.
			2. Check if the surface of the Star Wheel Holder Assy is flat.	2. Replace the Star Wheel Holder Assy with a new one.
Printing is blurred.		Printer driver & exclusive paper	1. Check if the suitable paper is used according to the printer driver setting.	1. Use the suitable paper according to the printer driver setting.
		Printhead	1. Check if the correct Head ID is stored into the EEPROM by using the Adjustment Program.	1. Input 16-digit code of the Head ID into the EEPROM by using the Adjustment Program.

Table 3-22. Check point for the defective printing quality

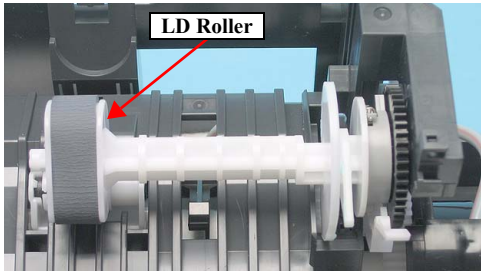
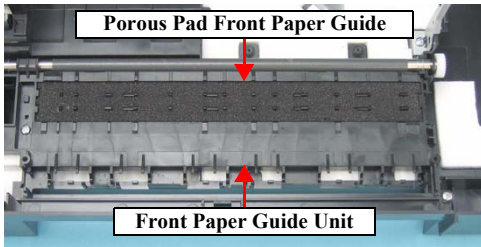
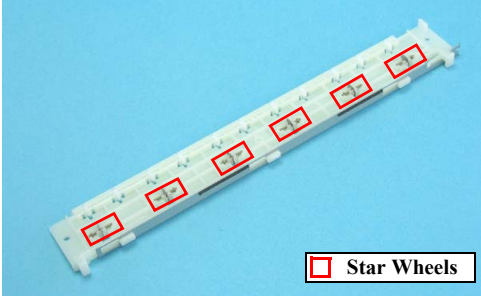
Print Quality State	Detailed phenomenon	Defective unit/part name	Check point	Remedy
• Print start position slip	The printing operation is correctly performed. But, the top margin is insufficient than usual one.	ASF Unit	1. Check if any paper dust is not adhered to the surface of the LD Roller. 	1. Set a cleaning sheet in the ASF up side down. Then holding the top edge, try to load the paper from the Printer driver. The micro pearl on the LD Roller surface is removed. To remove severe smear, staple a cloth moistened with alcohol to a post card and clean the roller in the same manner. As for the cleaning sheet, refer to “Check point for Paper out error according to each phenomenon” (p.75). * If the problem is not solved, replace the ASF Unit with a new one.
• Ink stain of paper	Ink stain occurs at the back, top end or bottom end of the print paper.	Front Paper Guide	1. Check if the Front Paper Guide Unit is free from ink stain. 	1. Clean the Front Paper Guide Unit with a soft cloth.
			2. Check if heaps of ink are not formed on Porous Pad Front Paper Guide.	2. Replace the Front Paper Guide Assy with a new one.
		EJ Roller Unit	1. Check if the EJ Roller Unit is free from ink stain.	1. Clean the EJ Roller Unit with a soft cloth.
		PF Roller Unit	1. Check if the PF Roller Unit is free from ink stain.	1. Clean the PF Roller Unit with a soft cloth.



Table 3-22. Check point for the defective printing quality

Print Quality State	Detailed phenomenon	Defective unit/part name	Check point	Remedy
• Ink stain of paper	Ink sticks to other than the print area of the paper, resulting in contamination.	Printhead	1. Check if the Printhead Cover does not have the ink drop.	1. Clean the Printhead Cover carefully with a soft cloth.
		Upper Paper Guide Unit	1. Check if the Upper Paper Guide Unit is free from ink stain.	1. Clean the Upper Paper Guide Unit with a soft cloth.
		Star Wheel Holder Assy	1. Check if the Star Wheels is free from ink stain. 	1. Clean the Star Wheels with a soft cloth.

**CHAPTER**

**4**

**DISASSEMBLY/ASSEMBLY**

## 4.1 Overview



In this chapter, the product names are called as follows:

Notation	Product name
CX7300 series	Stylus CX7300/CX7400/DX7400
TX200 series	Stylus NX200/TX200/TX203/TX209/SX200/SX205
CX8300 series	Stylus CX8300/CX8400/DX8400
TX400 series	Stylus NX400/TX400/TX405/TX409/SX400/SX405

This section describes procedures for disassembling the main components of EPSON Stylus CX7300/TX200/CX8300/TX400 series. Unless otherwise specified, disassembled units or components can be reassembled by reversing the disassembly procedure. Procedures which, if not strictly observed, could result in personal injury are described under the heading “WARNING”. “CAUTION” signals a precaution which, if ignored, could result in damage to equipment. Important tips for procedures are described under the heading “CHECK POINT”. If the assembly procedure is different from the reversed disassembly procedure, the correct procedure is described under the heading “REASSEMBLY”. Any adjustments required after reassembly of components or parts are described under the heading “ADJUSTMENT REQUIRED”. When you have to remove any components or parts that are not described in this chapter, refer to the exploded diagrams in the appendix.

Read the following precautions before disassembling and assembling.

### 4.1.1 Precautions

See the precautions given under the heading “WARNING” and “CAUTION” in the following columns when disassembling or assembling EPSON Stylus CX7300/TX200/CX8300/TX400 series.



- Disconnect the power cable before disassembling or assembling the printer.
- If you need to work on the printer with power applied, strictly follow the instructions in this manual.
- Always wear gloves for disassembly and reassembly to protect your eyes from ink. If any ink gets in your eyes, wash your eyes with clean water and consult a doctor immediately.
- Always wear gloves for disassembly and reassembly to avoid injury from sharp metal edges.
- To protect sensitive microprocessors and circuitry, use static discharge equipment, such as anti-static wrist straps, when accessing internal components.
- Never touch the ink or wasted ink with bare hands. If ink comes into contact with your skin, wash it off with soap and water immediately. If you have a skin irritation, consult a doctor immediately.



- When transporting the printer after installing the ink cartridge, pack the printer for transportation without removing the ink cartridge and be sure to secure the Ink Cartridge to the printer cover with tape tightly to keep it from moving.
- Use only recommended tools for disassembling, assembling or adjusting the printer.
- Observe the specified torque when tightening screws.
- Apply lubricants as specified. (See Chapter 6 “MAINTENANCE” (p151) for details.)
- Make the specified adjustments when you disassemble the printer. (See Chapter 5 “ADJUSTMENT” (p141) for details.)
- when reassembling the Waste Ink Tube, make sure that the tip of waste ink tube is placed in the correct position, otherwise ink may leak.
- When using compressed air products; such as air duster, for cleaning during repair and maintenance, the use of such products containing flammable gas is prohibited.

### 4.1.2 Tools

Use only specified tools to avoid damaging the printer.

**Table 4-1. Tools**

Name	EPSON Tool Code*
(+) Phillips screwdriver #1	1080530
(+) Phillips screwdriver #2	---
Flathead screwdriver	---
Flathead Precision screwdriver #1	---
Tweezers	---
Longnose pliers	---
Acetate tape	1003963
Nippers	---

Note \*: All of the tools listed above are commercially available.  
EPSON provides the tools listed with EPSON tool code.

### 4.1.3 Work Completion Check

If any service is made to the printer, use the checklist shown below to confirm all works are completed properly and the printer is ready to be returned to the user.

**Table 4-2. Work Completion Check**

Classification	Item	Check Point	Status
Printer Unit	Self-test	Is the operation normal?	<input type="checkbox"/> OK / <input type="checkbox"/> NG
	ON-line Test	Is the printing successful?	<input type="checkbox"/> OK / <input type="checkbox"/> NG
	Printhead (Nozzle check pattern print)	Is ink discharged normally from all the nozzles?	<input type="checkbox"/> OK / <input type="checkbox"/> NG
	Carriage Mechanism	Does it move smoothly?	<input type="checkbox"/> OK / <input type="checkbox"/> NG
		Is there any abnormal noise during its operation?	<input type="checkbox"/> OK / <input type="checkbox"/> NG
		Is the CR Motor at the correct temperature? (Not too hot to touch?)	<input type="checkbox"/> OK / <input type="checkbox"/> NG
	Paper Feeding Mechanism	Is paper advanced smoothly?	<input type="checkbox"/> OK / <input type="checkbox"/> NG
		No paper jamming?	<input type="checkbox"/> OK / <input type="checkbox"/> NG
		No paper skew?	<input type="checkbox"/> OK / <input type="checkbox"/> NG
		No multiple feeding?	<input type="checkbox"/> OK / <input type="checkbox"/> NG
		No abnormal noise?	<input type="checkbox"/> OK / <input type="checkbox"/> NG
		Is the paper path free of any obstructions?	<input type="checkbox"/> OK / <input type="checkbox"/> NG
		Is the PF Motor at correct temperature?	<input type="checkbox"/> OK / <input type="checkbox"/> NG

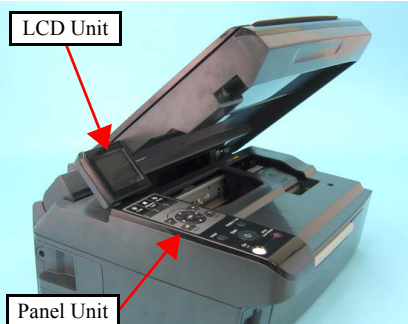

Table 4-2. Work Completion Check

Classification	Item	Check Point	Status
Scanner unit	Mechanism	Is glass surface dirty?	<input type="checkbox"/> OK / <input type="checkbox"/> NG
		Is any foreign substance mixed in the CR movement area?	<input type="checkbox"/> OK / <input type="checkbox"/> NG
	CR mechanism	Does CR operate smoothly?	<input type="checkbox"/> OK / <input type="checkbox"/> NG
		Does CR operate together with scanner unit?	<input type="checkbox"/> OK / <input type="checkbox"/> NG
		Does CR make abnormal noise during its operation?	<input type="checkbox"/> OK / <input type="checkbox"/> NG
LED	Does LED turn on normally? And is white reflection test done near home position?	<input type="checkbox"/> OK / <input type="checkbox"/> NG	
ON-line Test	ON-line Test	Is the operation normal?	<input type="checkbox"/> OK / <input type="checkbox"/> NG
Copy	Copy	Is the local copy action normal?	<input type="checkbox"/> OK / <input type="checkbox"/> NG
Adjustment	Specified Adjustment	Are all the adjustment done correctly	<input type="checkbox"/> OK / <input type="checkbox"/> NG
Lubrication	Specified Lubrication	Are all the lubrication made at the specified points?	<input type="checkbox"/> OK / <input type="checkbox"/> NG
		Is the amount of lubrication correct?	<input type="checkbox"/> OK / <input type="checkbox"/> NG
Function	ROM Version	Version:	<input type="checkbox"/> OK / <input type="checkbox"/> NG
Packing	Ink Cartridge	Are the ink cartridges installed correctly?	<input type="checkbox"/> OK / <input type="checkbox"/> NG
	Waste Ink pad	Are the waste ink pads adequate to absorb?	<input type="checkbox"/> OK / <input type="checkbox"/> NG
	Protective materials	Is the printer carriage placed at the capping position?	<input type="checkbox"/> OK / <input type="checkbox"/> NG
Others	Attachments, Accessories	Have all the relevant items been included in the package?	<input type="checkbox"/> OK / <input type="checkbox"/> NG

### 4.1.4 Procedural Differences between the Models

Some parts that are installed to CX7300/TX200 series and CX8300/TX400 series differ from each other because of the difference in the Panel Unit. The explanations in this chapter are based on CX8300/TX400 series. When reassembling the CX7300/TX200 series, refer to the table below to make sure the differences between the models.

**Table 4-3. Differences between Models**

Item	Description	CX8300/TX400 series	CX7300/TX200 series	Reference
Panel Unit	You need to follow different steps to remove the Panel Unit.	 <p>The diagram shows the top of the printer with the lid open. A red arrow points from a box labeled 'LCD Unit' to the top of the control panel. Another red arrow points from a box labeled 'Panel Unit' to the front edge of the control panel.</p>	 <p>The diagram shows the top of the printer with the lid open. A red arrow points from a box labeled 'Panel Unit' to the front edge of the control panel.</p>	<ul style="list-style-type: none"> <li>■ CX8300/TX400 series <a href="#">Panel Unit/LCD Unit (p103)</a></li> <li>■ CX7300/TX200 series <a href="#">Panel Unit (CX7300/TX200 series) (p139)</a></li> </ul>

## 4.2 Disassembly Procedures

For disassembling each unit, refer to the pages in the following flowchart.

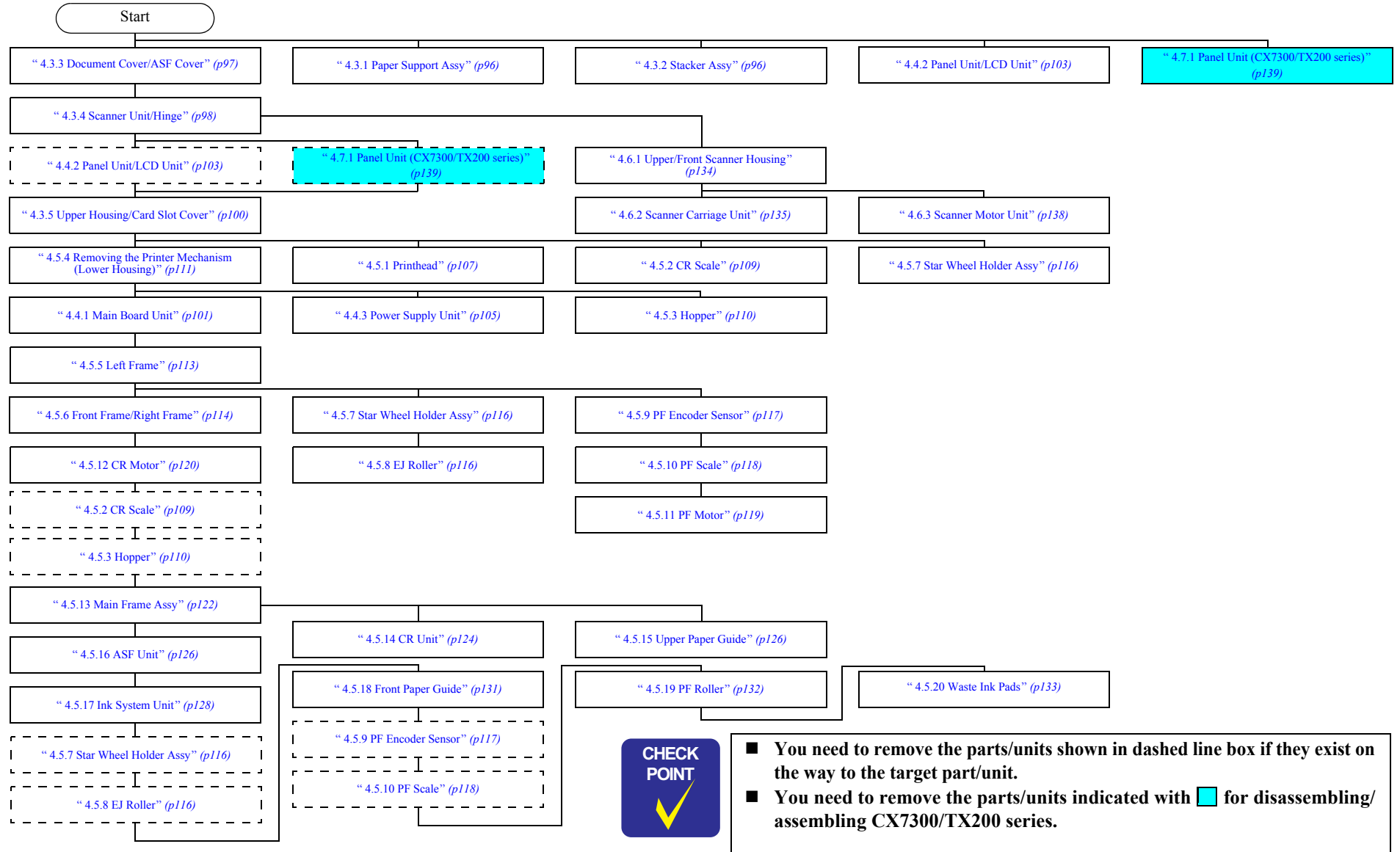


Figure 4-1. Disassembling Flowchart

## 4.3 Removing the Housing

### 4.3.1 Paper Support Assy

- Parts/Components need to be removed in advance: None
- Removal procedure
  1. Release the guide pins (x2) that secure the Paper Support Assy and remove it from the Upper Housing.

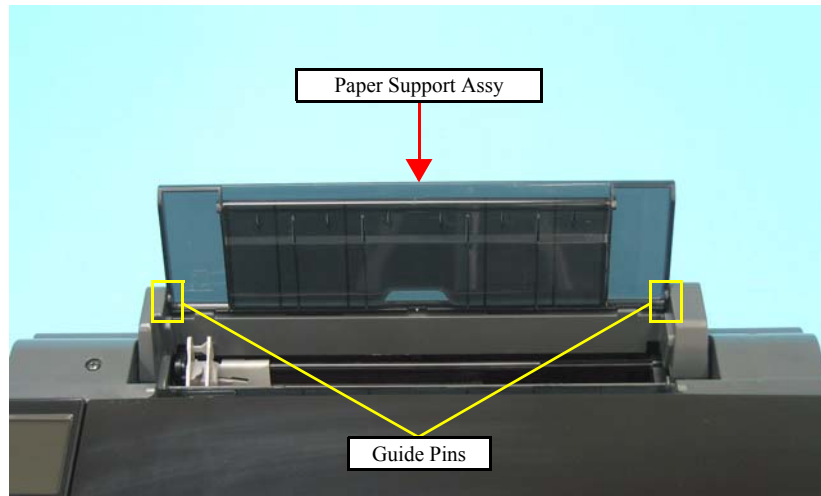


Figure 4-2. Removing the Paper Support Assy

### 4.3.2 Stacker Assy

- Parts/Components need to be removed in advance: None
- Removal procedure
  1. Open the Stacker Assy.
  2. Release the Stacker Assy while pressing in the hook (x1) on the left with a flathead precision screwdriver or a similar tool, and then remove it.

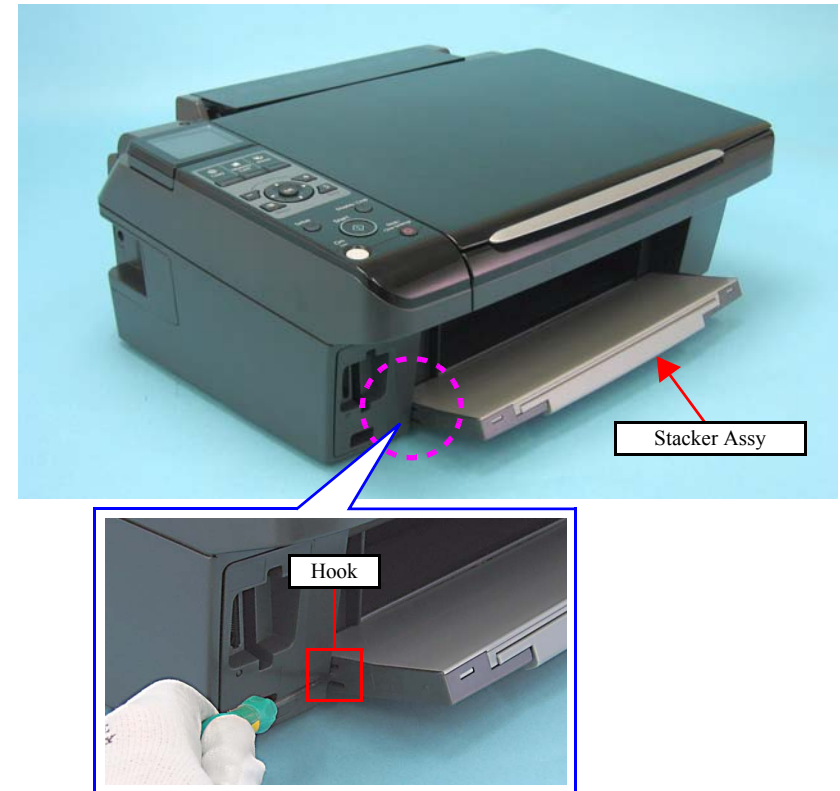


Figure 4-3. Removing the Stacker Assy



### 4.3.3 Document Cover/ASF Cover

□ Parts/Components need to be removed in advance: None

□ Removal procedure

■ Document Cover

1. Open the Paper Support Assy
2. Bend the Document Cover, and remove the Document Cover by releasing the guide pins on both sides from the Scanner Unit.



Figure 4-4. Removing the Document Cover

■ ASF Cover

1. Release the both guide pins of the ASF Cover from the holes of the Scanner Unit, and remove the ASF Cover.

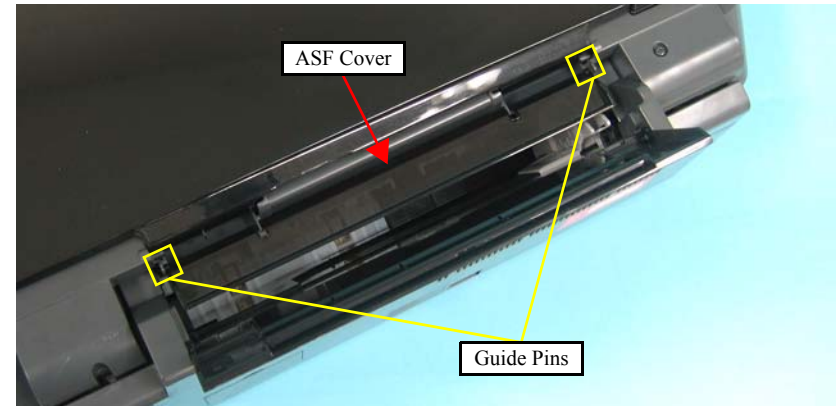


Figure 4-5. Removing the ASF Cover

### 4.3.4 Scanner Unit/Hinge

- Parts/Components need to be removed in advance

Document Cover/ASF Cover

- Removal procedure

1. Remove the screw (x1) that secures the USB Cover.
2. Pull the USB Cover at its screwing part, and remove it by sliding it to the left (in the direction of the arrow).

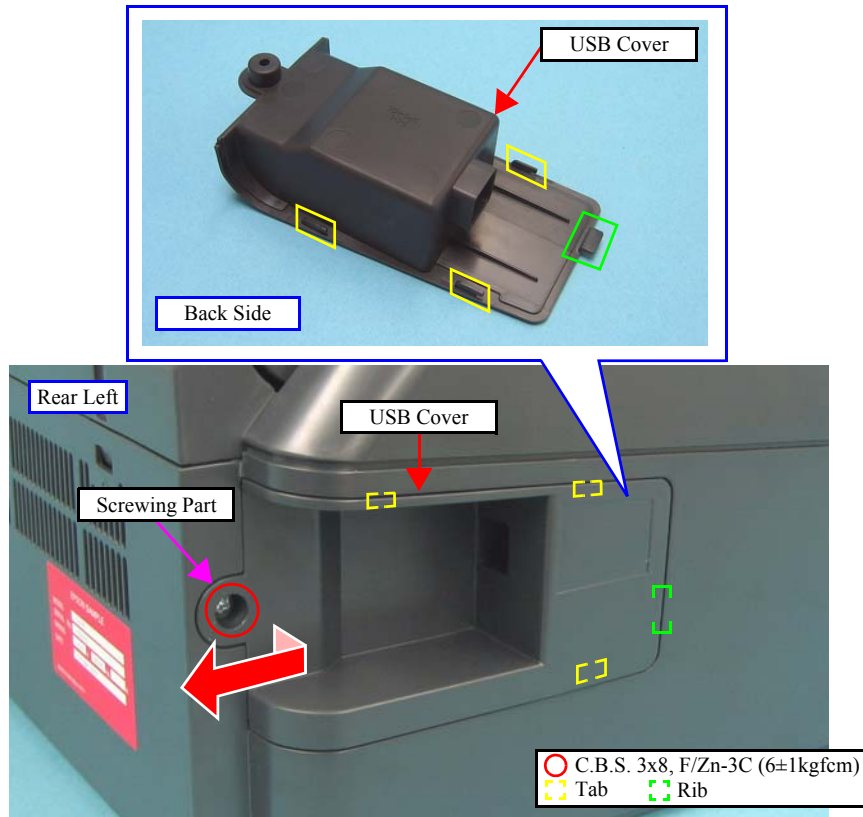


Figure 4-6. Removing the USB Cover



Be careful of the sharp edges shown in Figure 4-7 when assembling or reassembling.

3. Disconnect the Scanner Motor Cable from the connector (CN10) and the Scanner Carriage FFC from the connector (CN21) on the Main Board.
4. Peel off the double-sided tape (x1) that secures the Scanner Carriage FFC to the Main Board Frame.
5. Peel off the double-sided tape (x1) that secures the Scanner Carriage FFC to the Upper Housing.

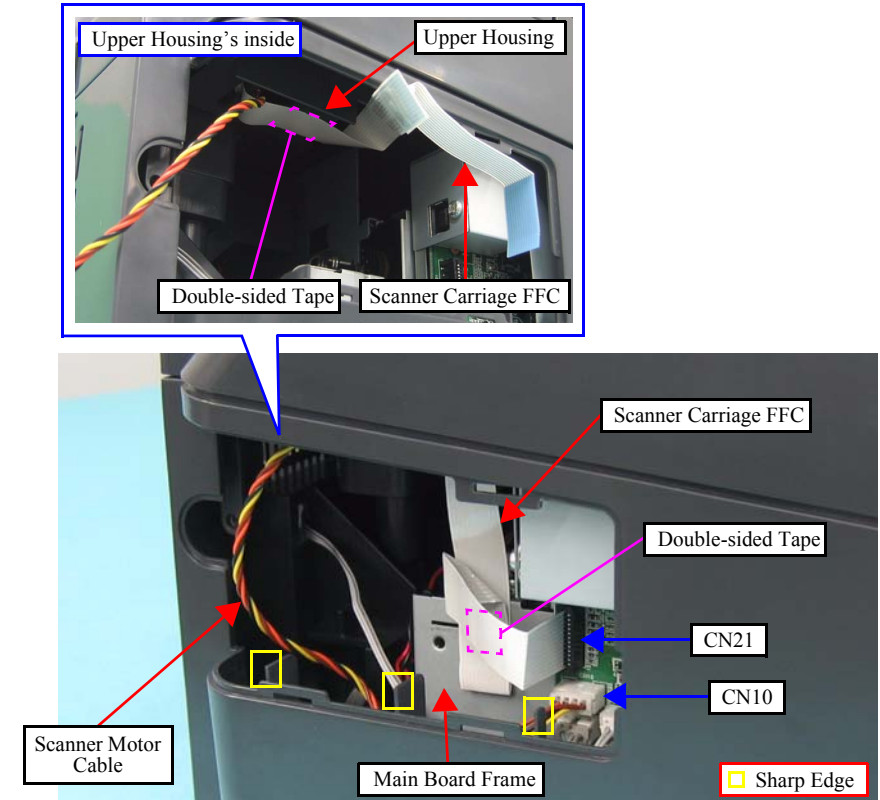


Figure 4-7. Removing the Scanner Unit (1)

6. Remove the screws (x2) that secure the Scanner Unit.
7. Open the Scanner Unit.
8. Pull out the Scanner Unit in the direction of the arrow, taking care not to let the Scanner Motor Cable and Scanner Carriage FFC get caught by the Upper Housing.

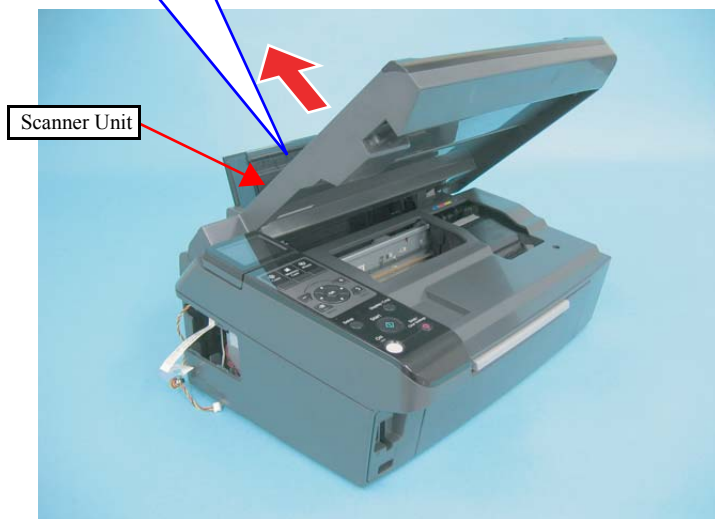
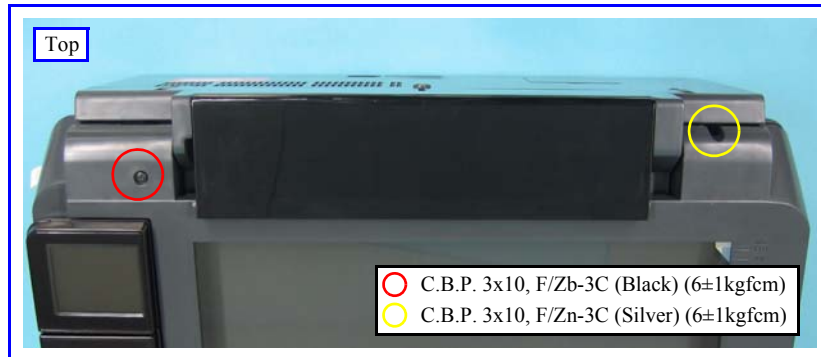


Figure 4-8. Removing the Scanner Unit (2)

9. Remove the screw (x1) that secures the Hinge and remove the Hinge.

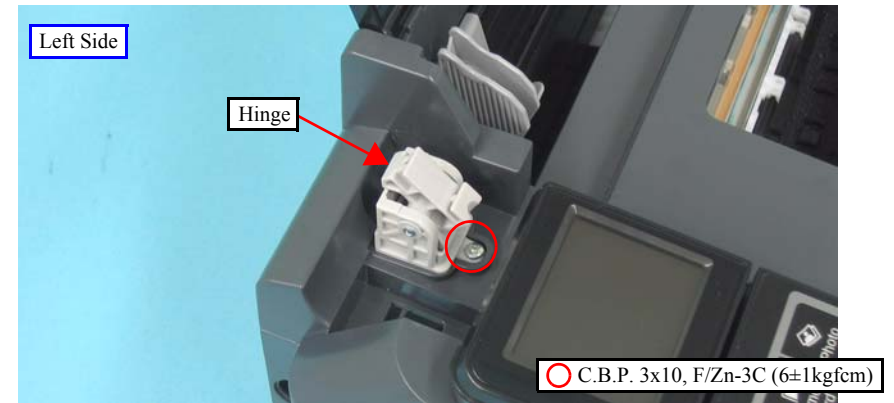


Figure 4-9. Removing the Hinge



- When installing the USB Cover, match the tabs (x3) with the positioning holes (x3) of the Upper Housing as shown in Figure 4-6.
- Route the Scanner Carriage FFC and secure it to the Upper Housing and Main Board Frame with double-sided tape as shown in Figure 4-7.
- When installing the Scanner Unit, engage the groove of the Scanner Unit with the hook of the Hinge as shown in Figure 4-10.

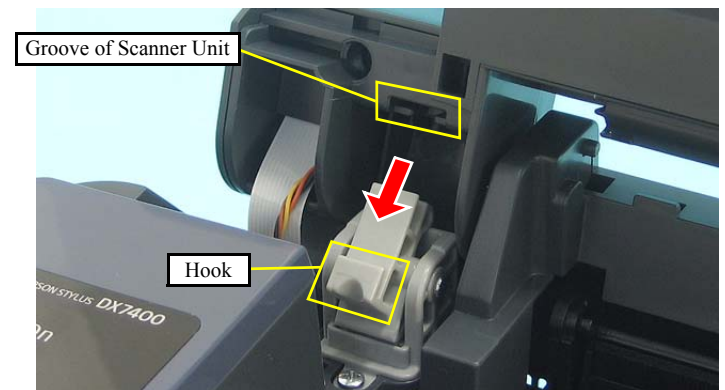


Figure 4-10. Installing the Scanner Unit

### 4.3.5 Upper Housing/Card Slot Cover

- Parts/Components need to be removed in advance  
Document Cover/ASF Cover/Scanner Unit/Panel Unit

- Removal procedure

- Upper Housing

1. Remove the screws (x6) that secure the Upper Housing.
2. Release the hooks (x5) that secure the Upper Housing and remove the Upper Housing.

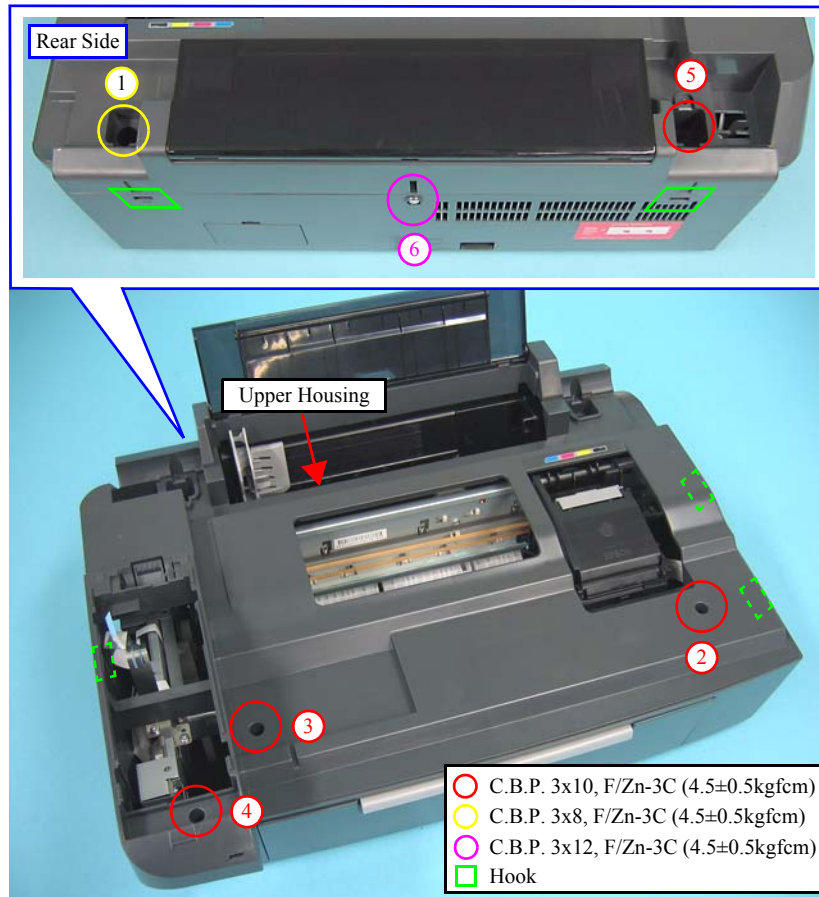


Figure 4-11. Removing the Upper Housing

- Card Slot Cover

1. Remove the screw (x1) that secures the Card Slot Cover.
2. Release the hook (x1) of the Card Slot Cover and remove the Card Slot Cover.

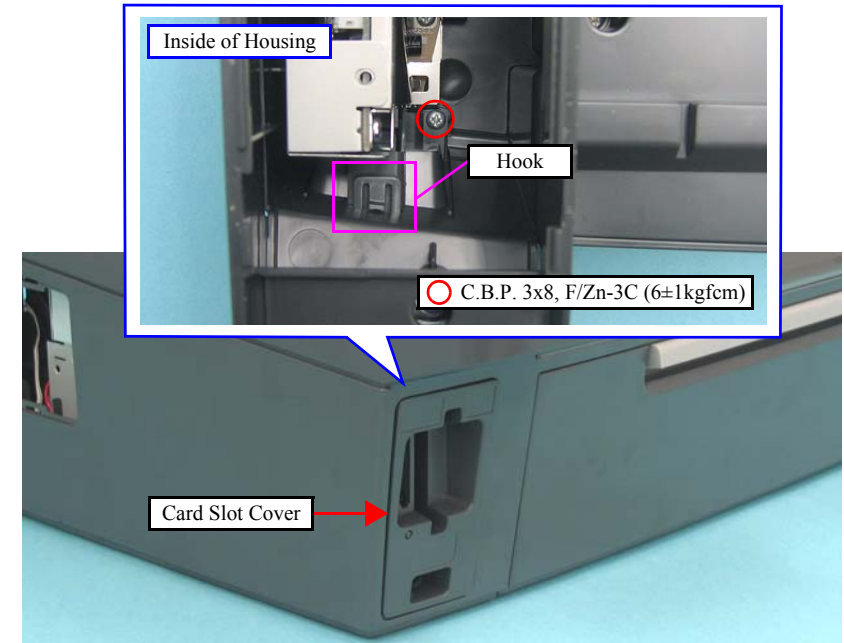


Figure 4-12. Removing the Card Slot Cover



- Tighten the screws in the order given in **Figure 4-11**.
- The Ink Position Label is not included in the Upper Housing. When replacing the Upper Housing, order the Ink Position Label separately and attach the label as shown below.

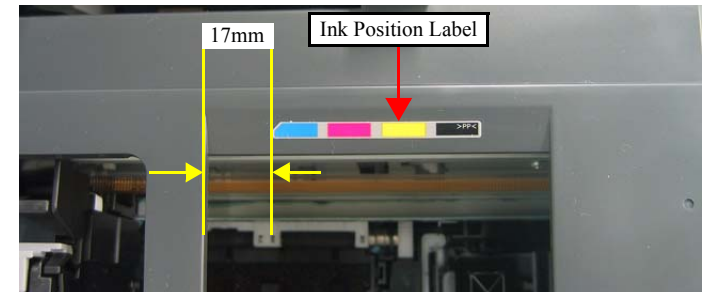


Figure 4-13. Attaching Ink Position Label

## 4.4 Removing the Circuit Boards

### 4.4.1 Main Board Unit

- Parts/Components need to be removed in advance

Document Cover/ASF Cover/Scanner Unit/Panel Unit/Upper Housing/Card Slot Cover/Lower Housing

- Removal procedure

1. Remove the screws (x2) that secure the Panel Grounding Plate to the Main Board Unit, and remove the Panel Grounding Plate.

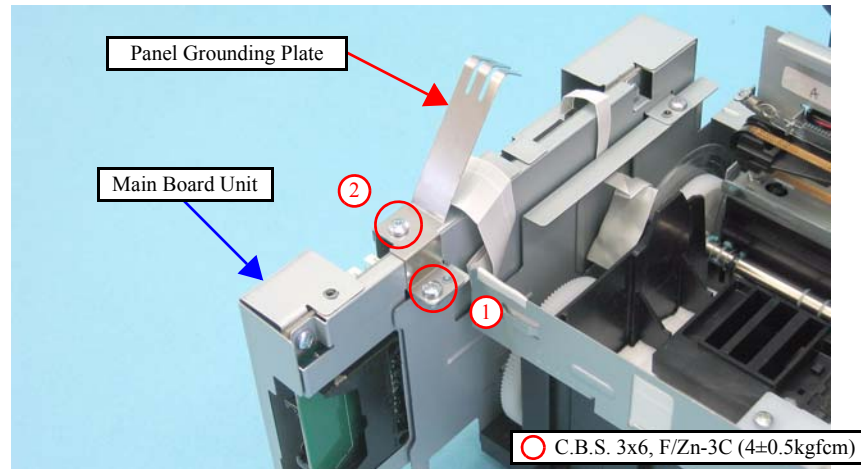


Figure 4-14. Removing the Panel Grounding Plate

2. Disconnect the following connectors (x4) and FFCs (x5) from the Main Board.

CN No.	Cable	CN No.	Cable
CN1	Power Supply Unit cable	CN9	PF Motor cable
CN5	Head FFC	CN11	PF Encoder FFC
CN6	Head FFC	CN12	Panel Unit FFC
CN7	Head FFC	CN24	PE Sensor cable
CN8	CR Motor cable		

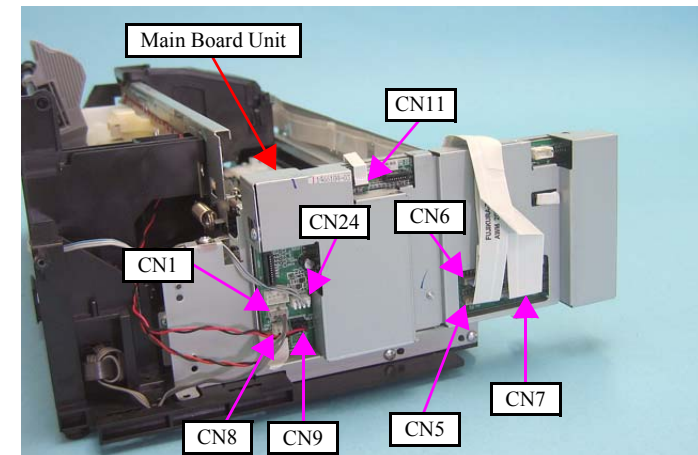


Figure 4-15. Removing the Main Board Unit (1)

3. Remove the screw (x1) that secures the Main Board Unit, and remove the Main Board Unit.

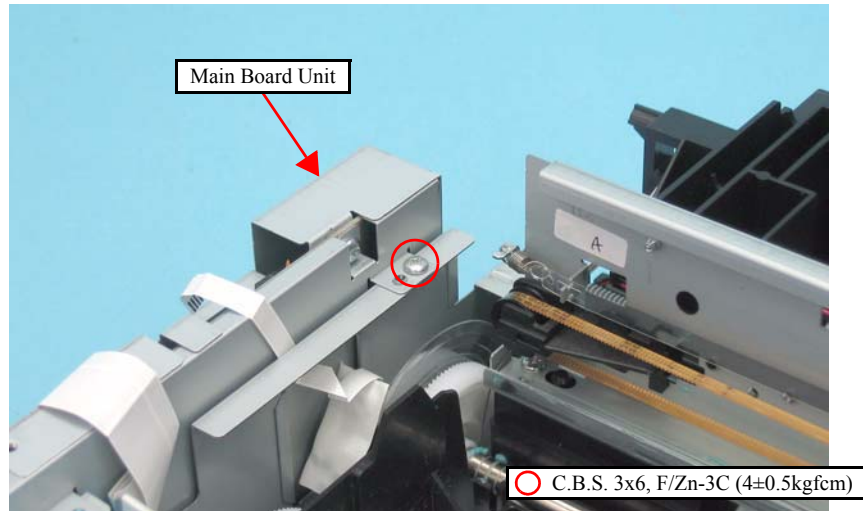


Figure 4-16. Removing the Main Board Unit (2)



- When installing the Main Board Unit, insert its hooks (x2) into the cutouts (x2) of the Left Frame.

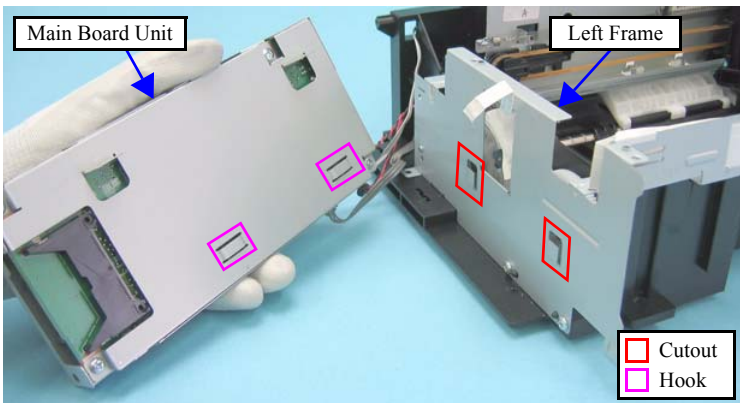


Figure 4-17. Installing the Main Board Unit

- Tighten the screws in the order given in Figure 4-14.

- Disassembling the Main Board Unit

1. Remove the Main Board Unit. (p101)
2. Peel off the acetate tape.
3. Remove the screws (x5) and remove the MB Lower Shield Plate.

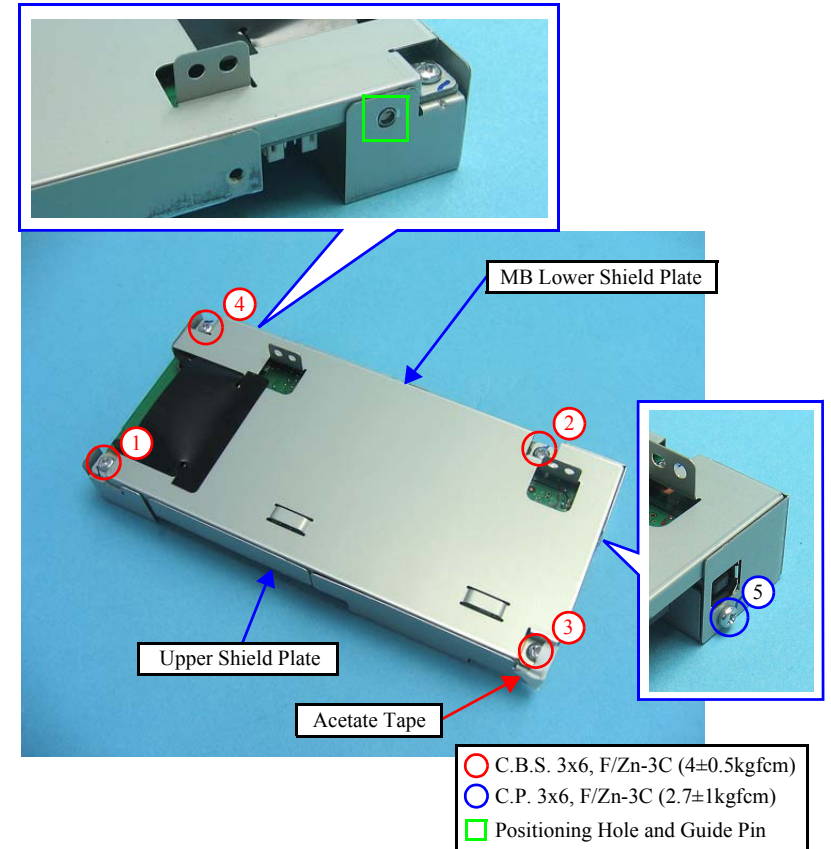


Figure 4-18. Removing the Main Board (1)

- Remove the screw (x1) that secures the Main Board, and remove the Main Board.

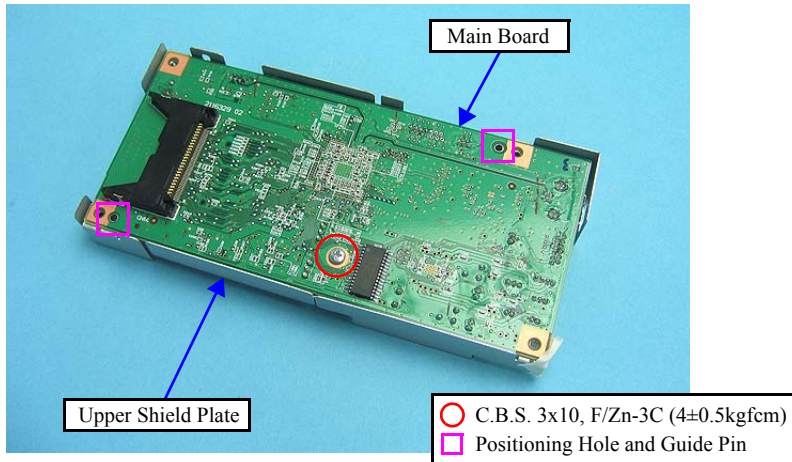


Figure 4-19. Removing the Main Board (2)



When installing the Main Board, pay attention to the following instructions.

- Match the positioning holes of the Upper Shield Plate with the guide pins of the Main Board as shown in [Figure 4-19](#).
- Match the positioning hole of the Main Board with the guide pin of the MB Lower Shield Plate as shown in [Figure 4-18](#).
- When installing the MB Lower Shield Plate, make sure that the Upper Shield Plate is set over the MB Lower Shield Plate as shown in [Figure 4-18](#).



Whenever the Main Board is removed/replaced, the required adjustments must be carried out.

- Chapter 5 “ADJUSTMENT” (p.141)

## 4.4.2 Panel Unit/LCD Unit

- Parts/Components need to be removed in advance: None



The disassembling/assembling procedures differ depending on the models. As for CX7300/TX200 series, see [4.7.1 Panel Unit \(CX7300/TX200 series\) \(p139\)](#).

- Removal procedure
  - Open the Scanner Unit
  - Raise the LCD Unit.



Do not lift the Panel Unit too fast, since the Panel FFC is connected to it.

- Lifting the front of the Panel Unit, and release the tabs of it.
- Slide the Panel Unit in the direction of the arrow, and release the hooks of it from the Upper Housing.

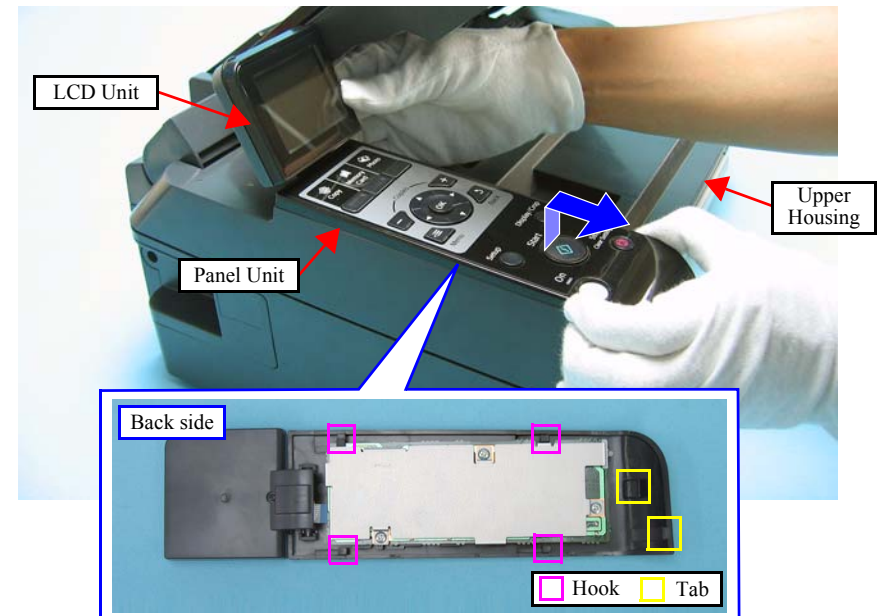


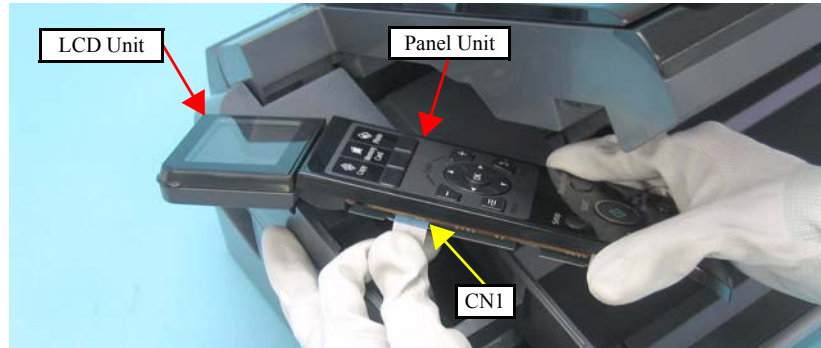
Figure 4-20. Removing the Panel Unit and LCD Unit (1)

**CHECK POINT**



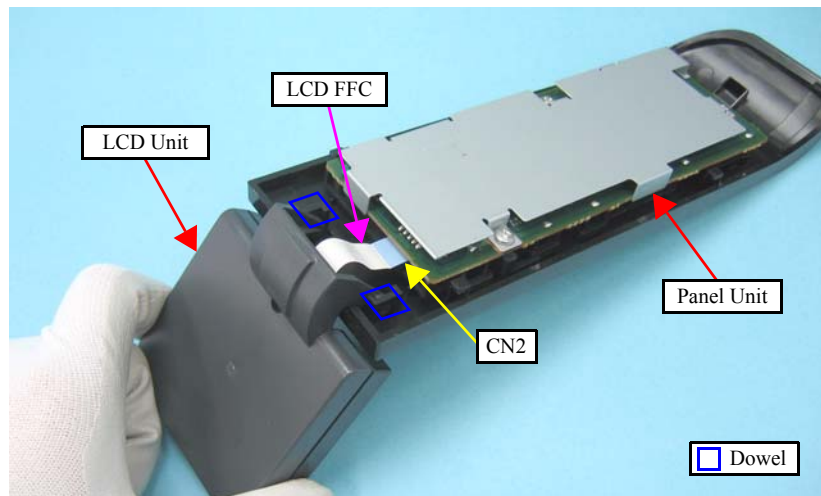
**Be sure to disconnect the Panel FFC from the connector on the Panel Board.**

5. Disconnect the Panel FFC from the connector (CN1) of the Panel Board, and remove the Panel Unit together with the LCD Unit.



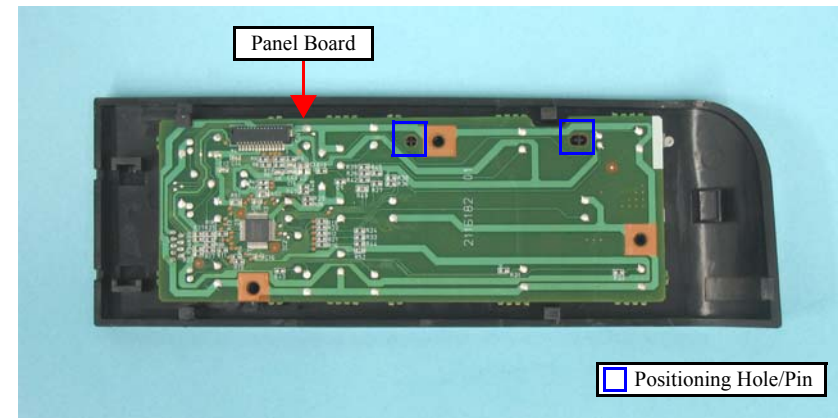
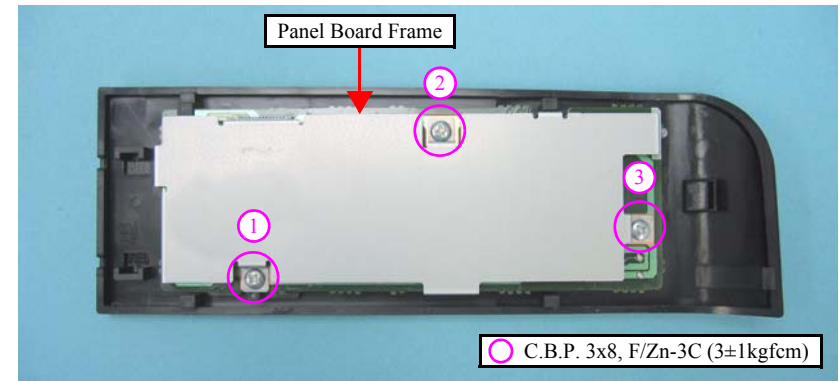
**Figure 4-21. Removing the Panel Unit and LCD Unit (2)**

6. Disconnect the LCD FFC from the connector (CN2) of the Panel Unit.
7. Release the dowels (x2) that secure the LCD Unit, and separate the LCD Unit from the Panel Unit.



**Figure 4-22. Removing the Panel Unit and LCD Unit (3)**

8. Remove the screws (x3) that secure the Panel Board and Panel Board Frame, and remove the Panel Board together with the Panel Board Frame.



**Figure 4-23. Removing the Panel Board**



- Remove each switch button from the Panel Cover.

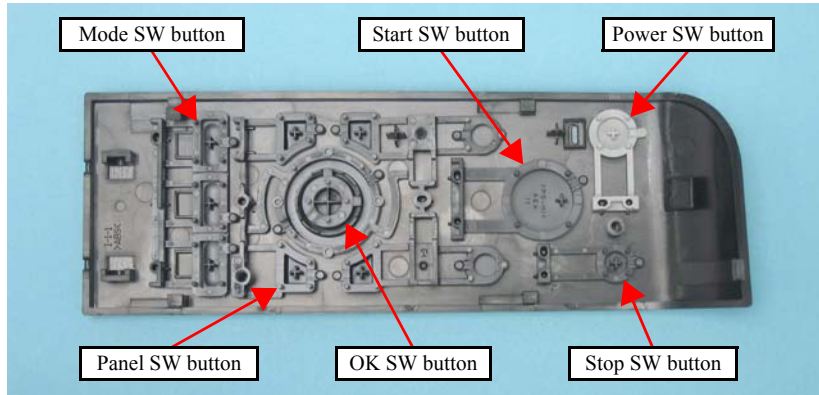


Figure 4-24. Removing the Switch button



- When installing the Panel Board, match the positioning holes of the Panel Board with their positioning pins of the Panel Housing as shown in Figure 4-23.
- Tighten the screws in the order given in Figure 4-23.
- The Panel Sheet is not included in the ASP unit of the Panel Unit. When replacing the Panel Unit, order the Panel Sheet separately and attach it on the specified place as shown in the figure below.

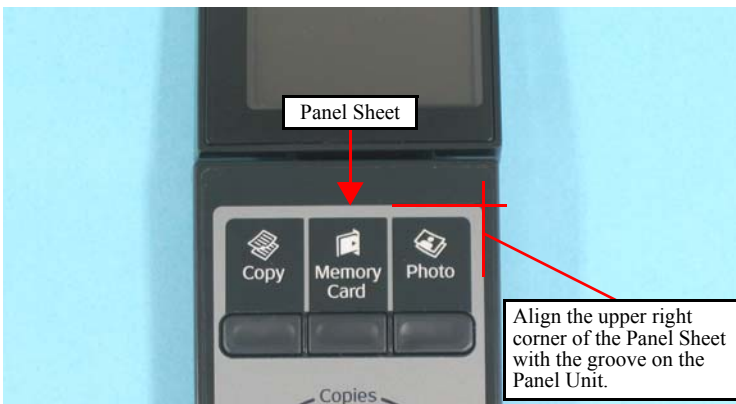


Figure 4-25. Panel Sheet Position

### 4.4.3 Power Supply Unit

- Parts/Components need to be removed in advance  
Document Cover/ASF Cover/Scanner Unit/Panel Unit/Upper Housing/Card Slot Cover/Lower Housing
- Removal procedure
  - Disconnect the connector of the Power Supply Unit (CN1) on the Main Board.
  - Release the Power Unit Cable from the hook of the Base Frame.

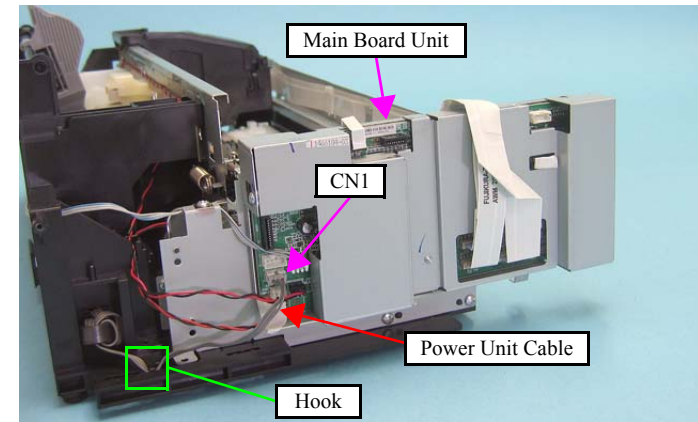


Figure 4-26. Removing the Power Supply Unit (1)

- Remove the screws (x2) that secure the Power Supply Unit.
- Lift the Base Frame a little, and remove the Power Supply Unit.

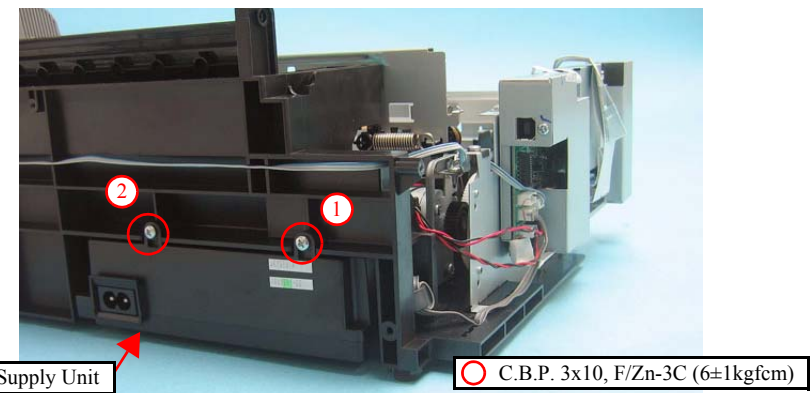


Figure 4-27. Removing the Power Supply Unit (2)



When installing the Power Supply Unit, make sure to check the following points.

- Insert the tabs (x2) of the Power Supply Unit into the holes on the Base Frame.

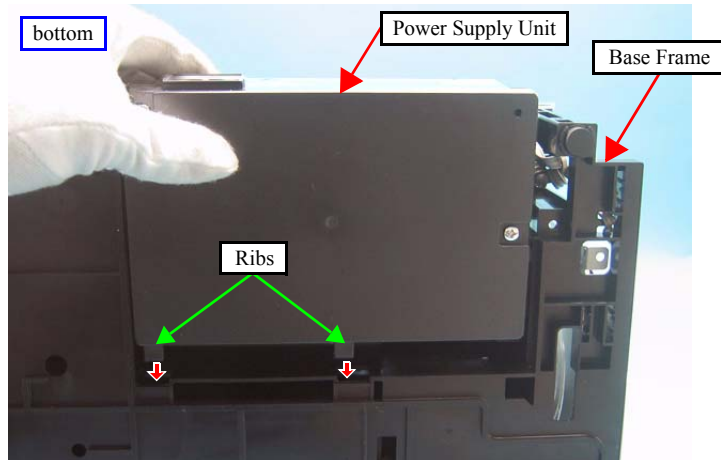


Figure 4-28. Installing the Power Supply Unit

- Tighten the screws in the order given in [Figure 4-27](#).
- Secure the Power Unit Cable with the hook of the Base Frame as shown in the figure below.
- Put the ferrite core of the Power Supply Unit cable into the cutout of the Base Frame.

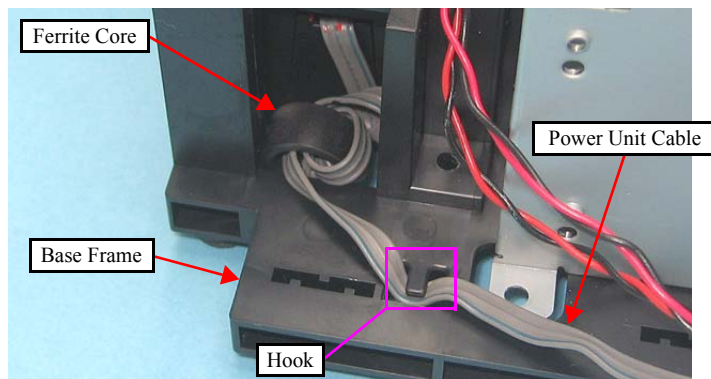


Figure 4-29. Routing the Power Unit Cable



Whenever the Power Supply Unit is removed/replaced, the required adjustments must be carried out.

- [Chapter 5 “ADJUSTMENT” \(p.141\)](#)

## 4.5 Disassembling the Printer Mechanism

### 4.5.1 Printhead

- Parts/Components need to be removed in advance

Document Cover/ASF Cover/Scanner Unit/Panel Unit/Upper Housing

- Removal procedure

1. Rotate the Spur Gear 51.5 to unlock the carriage, and move the CR Unit to the center.

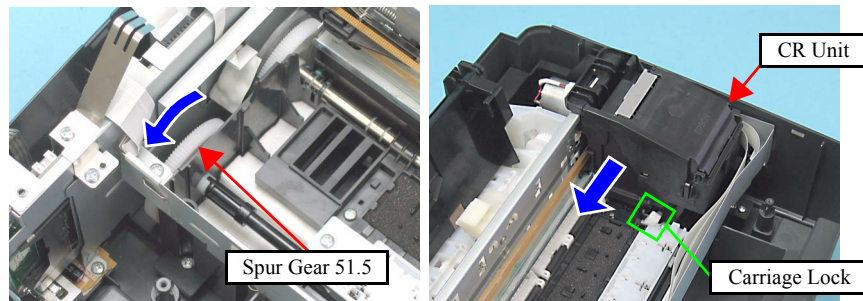


Figure 4-30. Unlocking the Carriage and Moving the CR Unit

2. Open the Cartridge Cover and remove all the ink cartridges from the CR Unit.
3. Release the hook (x1) of the Head Cable Cover with a flathead precision screwdriver, and remove the Head Cable Cover while sliding it downward (in the direction of the arrow).

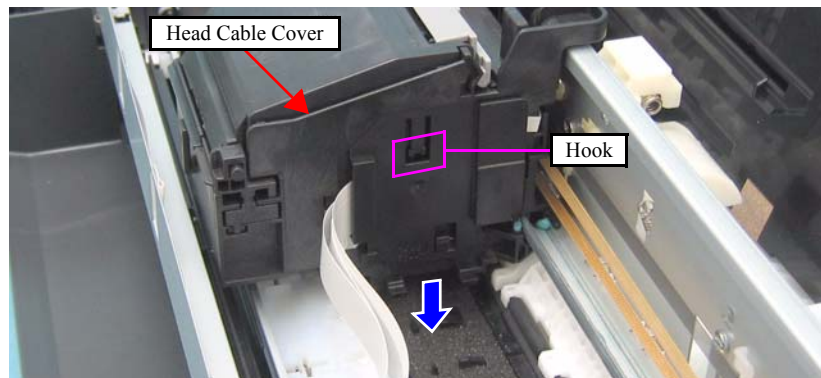


Figure 4-31. Removing the Head Cable Cover

4. Disconnect the Head FFC (x1) that is connected to the CSIC Board.
5. Release the tabs (x2) that secure the Holder Board Assy using a needle or a similar tool, and remove the Holder Board Assy upward (in the direction of the arrow).

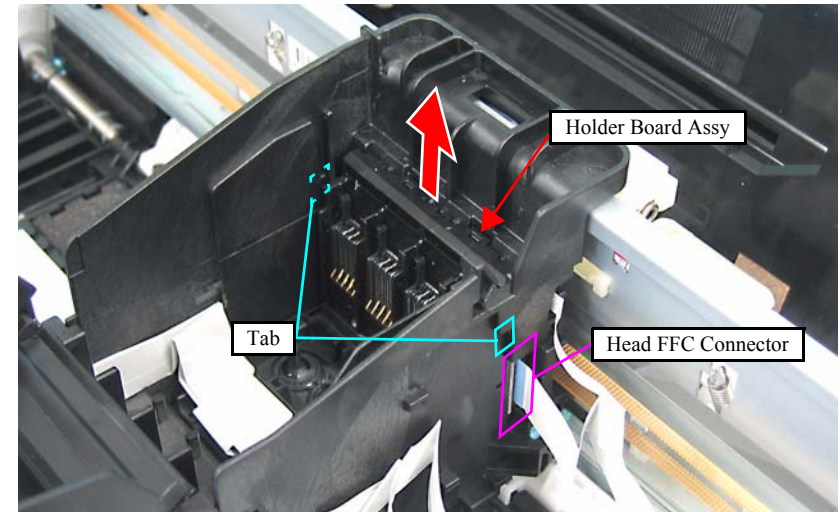


Figure 4-32. Removing the Holder Board Assy

6. Remove the Sub FFC Guide following the steps below.
  - 6-1. Release the hook (x1) of the Sub FFC Guide from the cutout (x1) of the CR Unit.
  - 6-2. Release the cutout (x1) of the Sub FFC Guide from the groove (x1) of the CR Unit.
  - 6-3. Release the rib of the Sub FFC Guide from the cutout of the CR Unit.

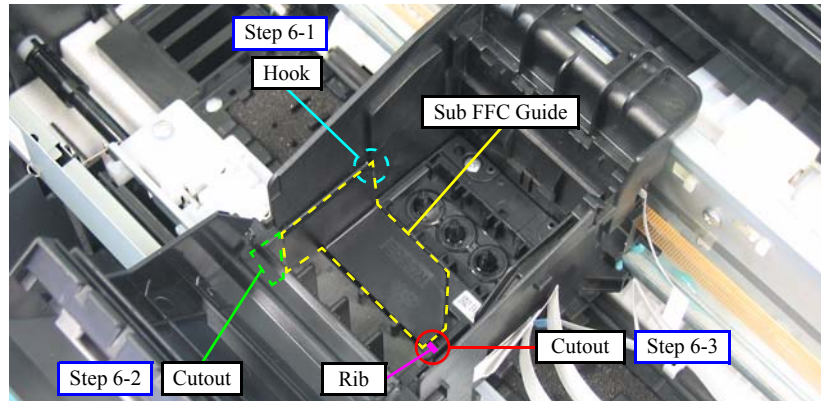


Figure 4-33. Removing the Sub FFC Guide



**Do not touch or damage the nozzles or the ink supply needles of the Printhead.**

7. Remove the screws (x3) that secure the Printhead, and lift the Printhead with longnose pliers.

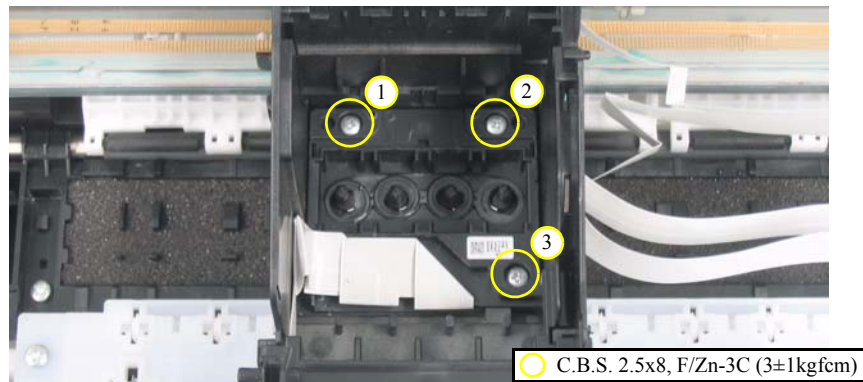


Figure 4-34. Removing the Printhead (1)

8. Disconnect the Head FFC from the connectors (x2) of the Printhead, and remove the Printhead.

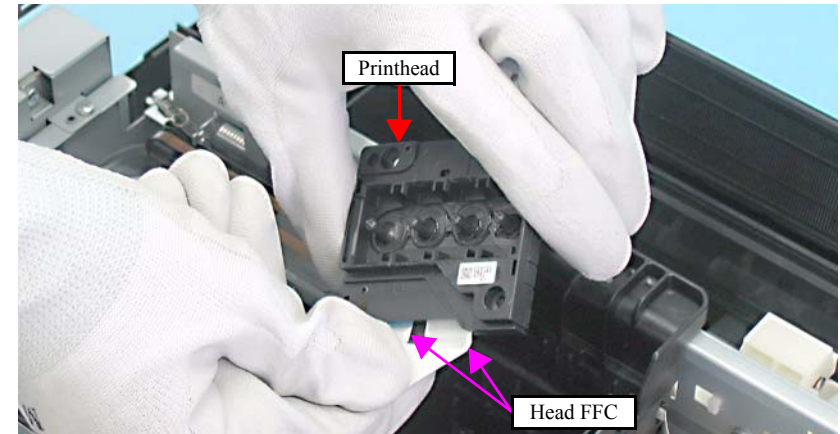


Figure 4-35. Removing the Printhead (2)



- Install the Sub FFC Guide following the steps below.
  1. Insert the blade (x1) of the Sub FFC Guide between the ribs (x2) of the CR Unit.
  2. Insert the rib (x1) of the Sub FFC Guide into the cutout (x1) of the CR Unit.
  3. Press down the Sub FFC Guide to secure it.

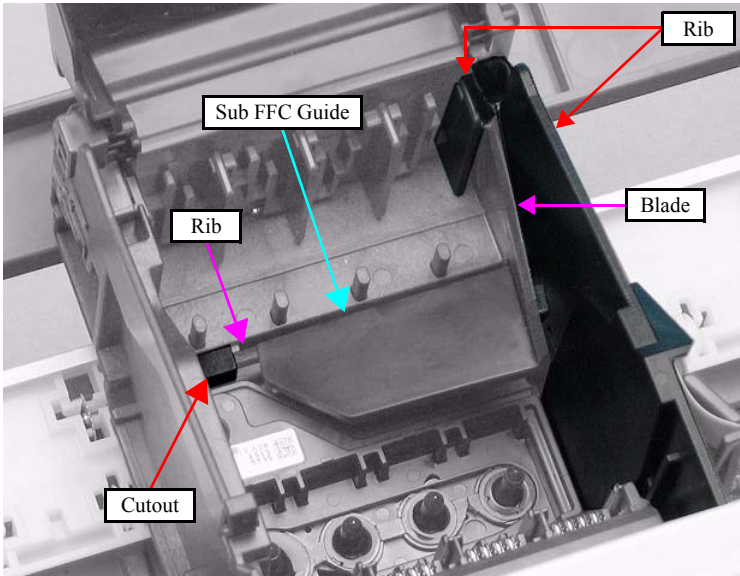


Figure 4-36. Installing the Sub FFC Guide

- Tighten the screws in the order given in [Figure 4-34](#).
- Insert the Holder Board Assy vertically into the CR Unit so as not to put the Holder Board Assy on the rib of the Printhead.



Whenever the Printhead is removed/replaced, the required adjustments must be carried out.

- [Chapter 5 “ADJUSTMENT” \(p.141\)](#)

## 4.5.2 CR Scale

- Parts/Components need to be removed in advance  
Document Cover/ASF Cover/Scanner Unit/Panel Unit/Upper Housing
- Removal procedure



Pay attention to the following instructions:

- Do not touch the CR Scale with bare hands.
- Do not damage the CR Scale.
- Do not stretch Extension Spring 3.289 too much.

1. Release the right end of the CR Scale from the hook.
2. Pull out the CR Scale through the slit of the CR Encoder Sensor.

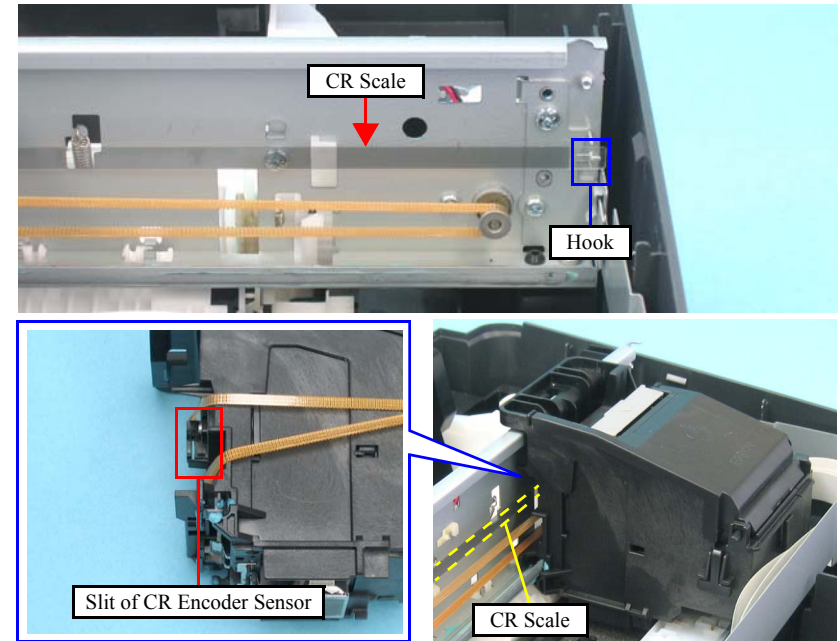


Figure 4-37. Removing the CR Scale (1)

3. Release the Extension Spring 3.289 from the hook of the Main Frame.
4. Rotate the CR Scale 90 degrees as shown in the figure and remove the scale from the Main Frame.

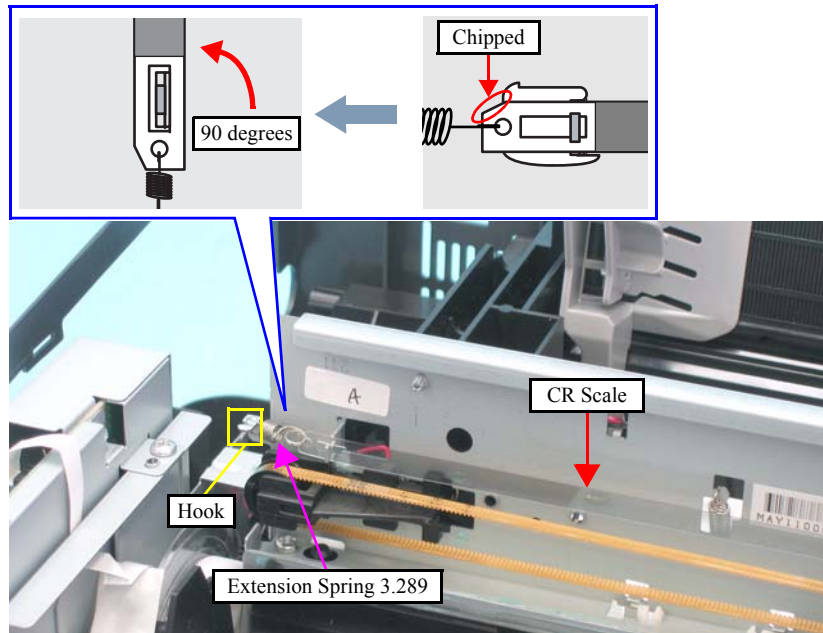


Figure 4-38. Removing the CR Scale (2)



When installing the CR Scale, pay attention to the following instructions:

- Chipped part of the CR Scale must face upward.
- CR scale should be passed through the slit of the CR Encoder Sensor.
- Make sure that the Extension Spring 3.289 is not be twisted, and then attach its end to the hook of the Main Frame.

### 4.5.3 Hopper

- Parts/Components need to be removed in advance

Document Cover/ASF Cover/Scanner Unit/Panel Unit/Upper Housing/Card Slot Cover/Lower Housing

- Removal procedure

1. Release the dowel A of the Hopper.
2. Release the dowel B of the Hopper, and remove the Hopper together with the Compression Spring 1.94.

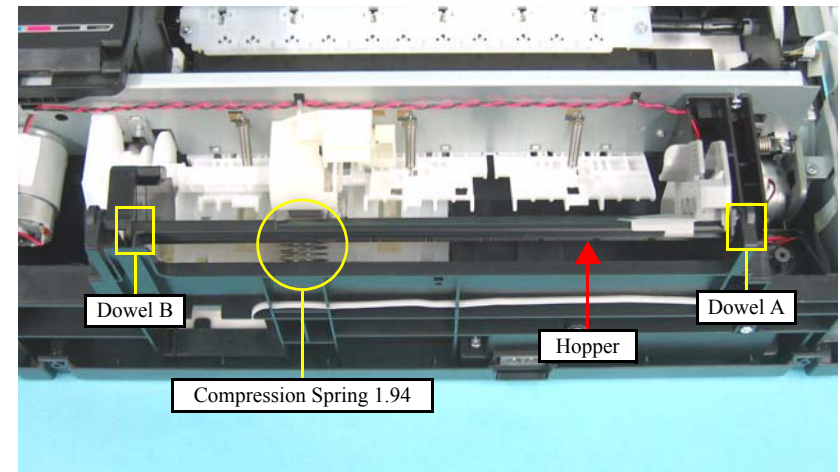


Figure 4-39. Removing the Hopper



When installing the Hopper, be sure to engage the rib of the Hopper with the guide groove of the Base Frame.

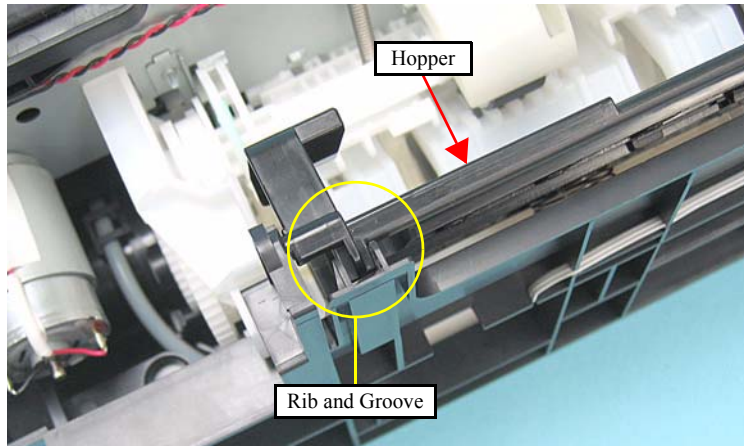


Figure 4-40. Installing the Hopper



Whenever the Hopper is removed/replaced, the required adjustments must be carried out.

- Chapter 5 “ADJUSTMENT” (p.141)

#### 4.5.4 Removing the Printer Mechanism (Lower Housing)

- Parts/Components need to be removed in advance  
Document Cover/ASF Cover/Scanner Unit/Panel Unit/Upper Housing/Card Slot Cover
- Removal procedure
  1. Disconnect the Interface Connector Cable (CN3) and Panel FFC (CN12) from the Main Board.
  2. Release the Interface Connector Cable from the hook of the Main Board Unit.

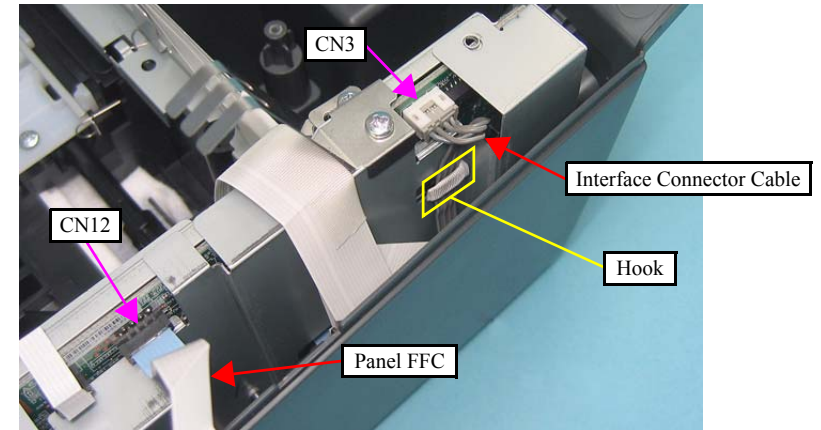


Figure 4-41. Removing the Printer Mechanism (1)

3. Release the hook that secures the Rear Cover and remove the Rear Cover.

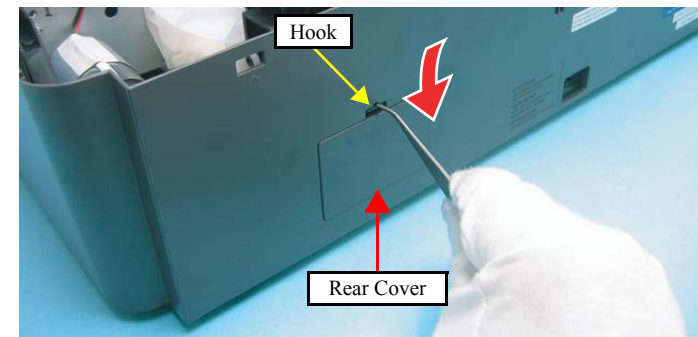


Figure 4-42. Removing the Printer Mechanism (2)

**CAUTION**



When lifting the Printer Mechanism, be sure to hold the positions specified in the figure below to prevent the Main Frame from being deformed.

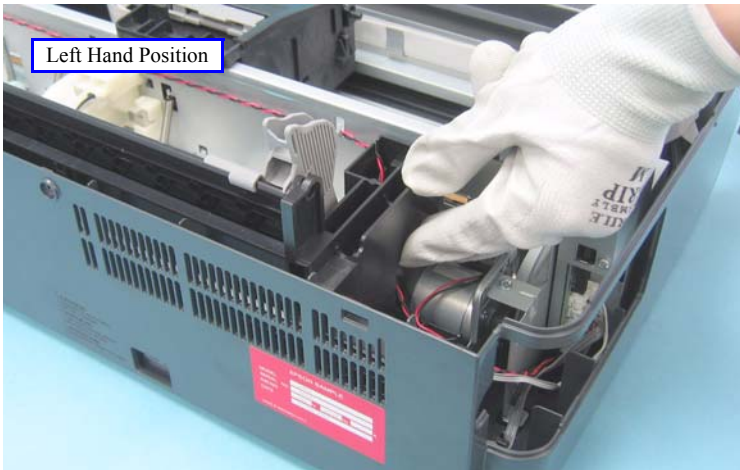
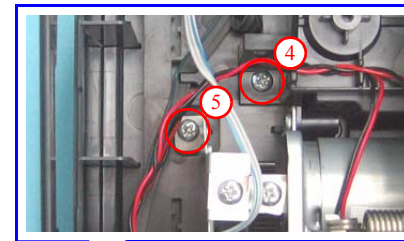


Figure 4-43. Printer Mechanism Handling Precaution

- Remove the screws (x5) that secure the Printer Mechanism, and remove the Printer Mechanism.



○ C.B.P. 3x10, F/Zn-3C (6±1kgfcm)

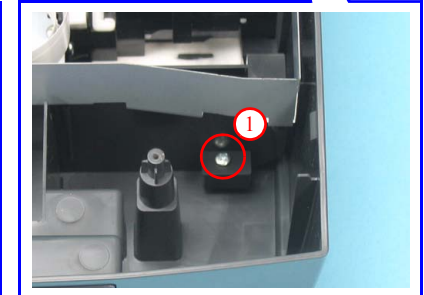
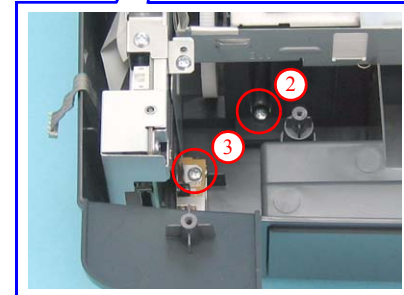
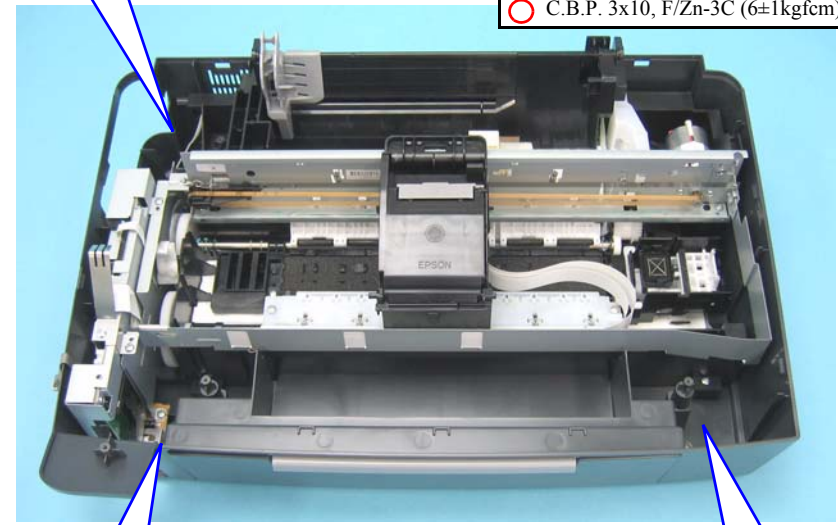


Figure 4-44. Removing the Printer Mechanism (2)





Before installing the Printer Mechanism, hang the Interface Connector Cable on the Lower Housing so as not to damage the cable with the Printer Mechanism.

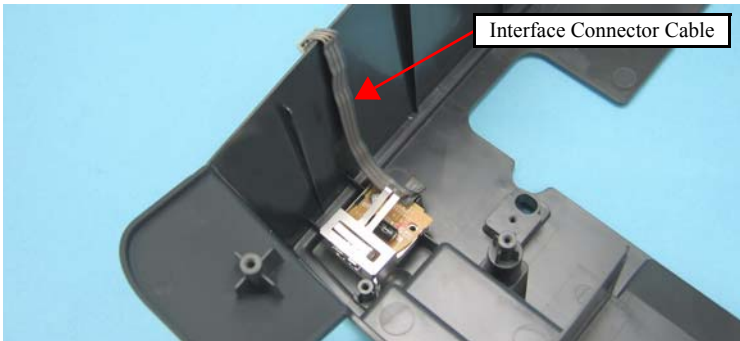


Figure 4-45. Routing the Interface Connector Cable

### 4.5.5 Left Frame

- Parts/Components need to be removed in advance

Document Cover/ASF Cover/Scanner Unit/Panel Unit/Upper Housing/Card Slot Cover/Lower Housing/Main Board Unit

- Removal procedure

1. Remove the screws (x5) that secure the Left Frame, and remove the Left Frame.

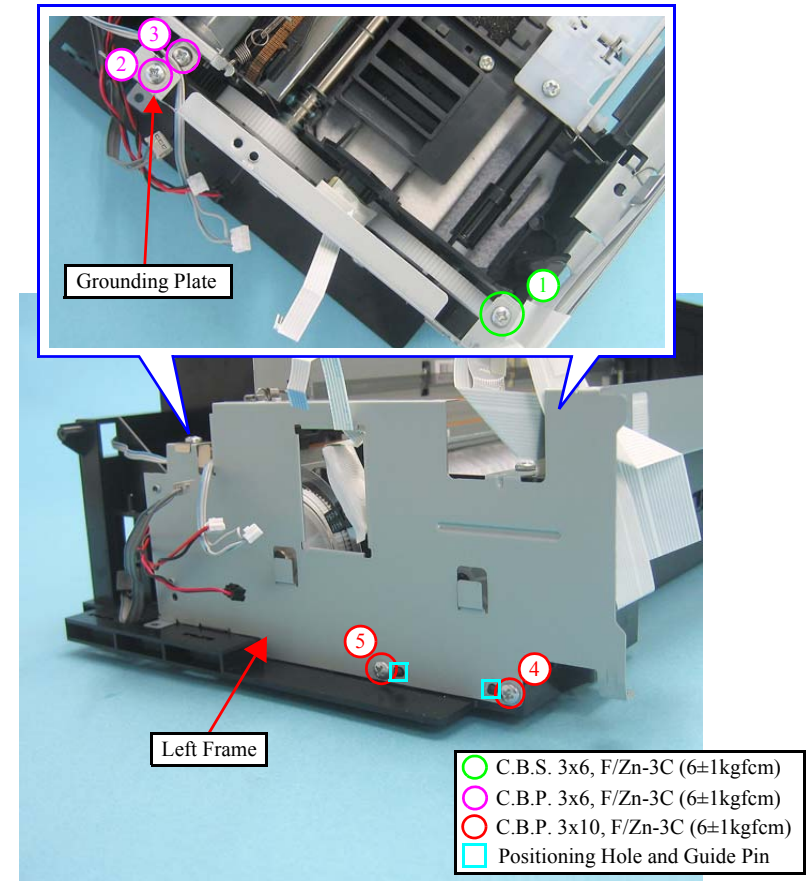


Figure 4-46. Removing the Left Frame



- When installing the Left Frame, lead the PF Encoder FFC through the hole of the Left Frame.

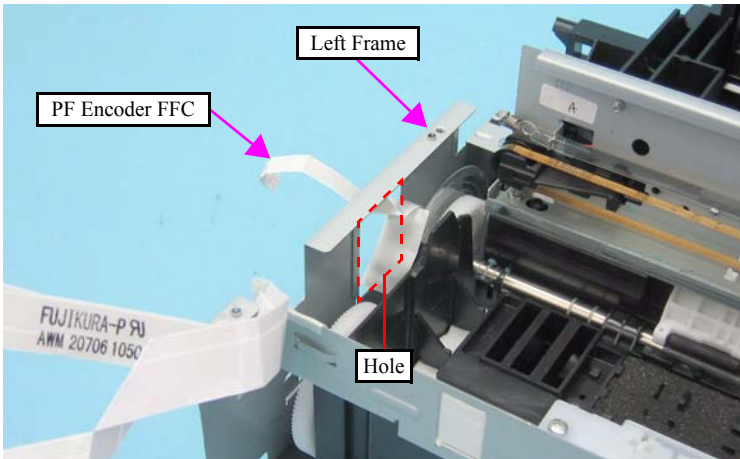


Figure 4-47. Routing the PF Encoder FFC

- When installing the Left Frame, match the guide pins (x2) of the Base Frame with their positioning holes (x2) of the Left Frame as shown in Figure 4-46.
- Tighten the screws in the order given in Figure 4-46.

## 4.5.6 Front Frame/Right Frame

- Parts/Components need to be removed in advance  
Document Cover/ASF Cover/Scanner Unit/Panel Unit/Upper Housing/Card Slot Cover/Lower Housing/Main Board Unit/Left Frame
- Removal procedure
  1. Remove the acetate tape (x1) that secures the Head FFC to the Front Frame.
  2. Release the Head FFC from the hooks (x3) of the Front Frame.
  3. Remove the Grounding Spring from the Front Frame.

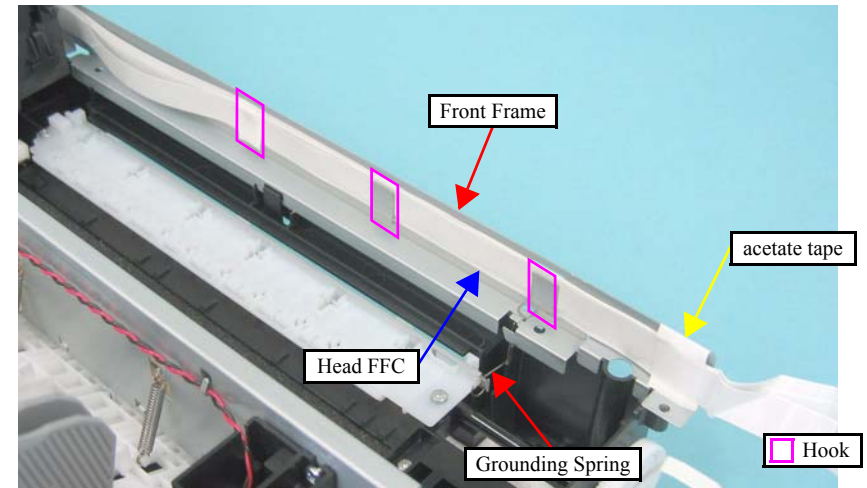


Figure 4-48. Removing the Front Frame/Right Frame (1)

4. Remove the screw (x1) that secures the Front Frame and the Right Frame together.
5. Release the dowel (x1) and the hook (x1) that secure the Right Frame, and remove the Right Frame.

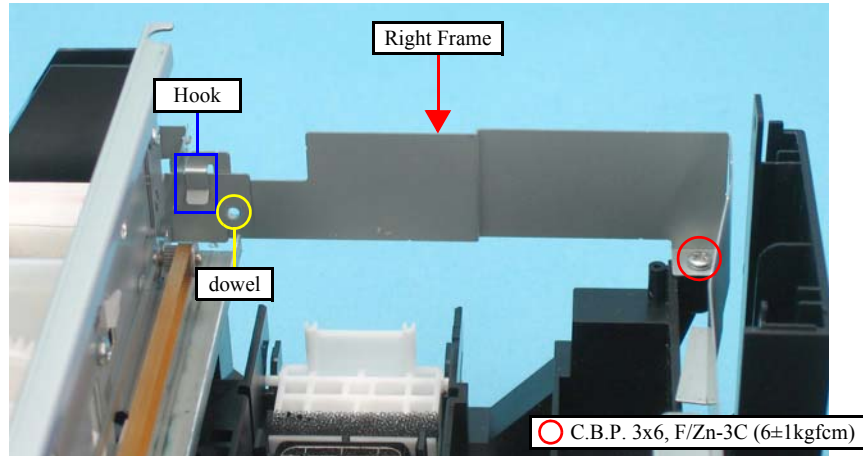


Figure 4-49. Removing the Front Frame/Right Frame (2)

6. Release the hook (x1), and remove the Front Frame.

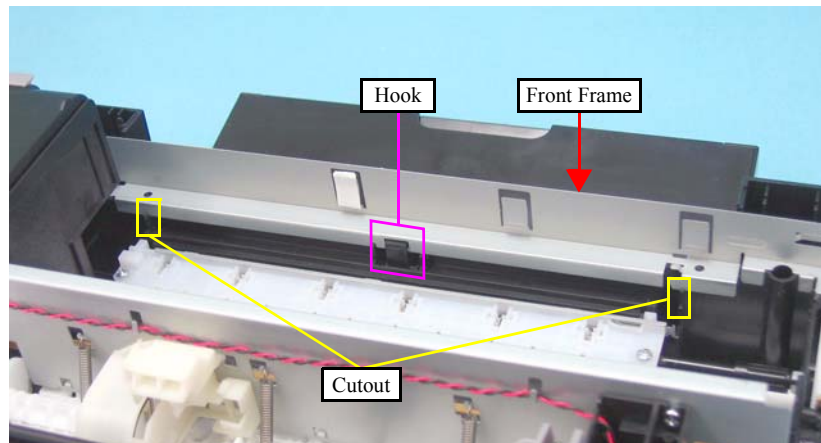


Figure 4-50. Removing the Front Frame/Right Frame (3)



- After replacing the Front Frame, be sure to attach an acetate tape referring to the figure below.

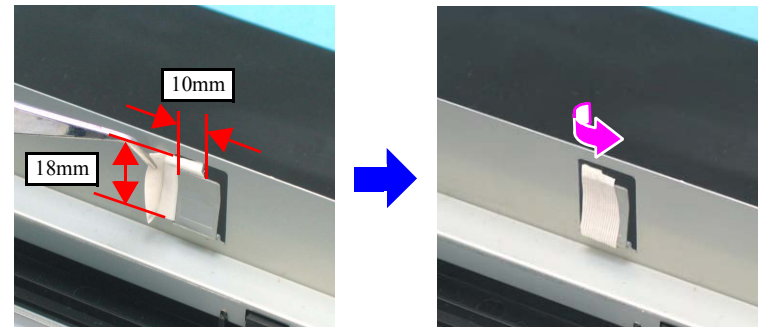


Figure 4-51. Acetate Tape Position

- When installing the Front Frame, pay attention to the following instructions.
  - As shown in Figure 4-50, be sure to secure the Front Frame with the hook (x1) and the cutouts (x2).
  - As shown in Figure 4-49, secure the Front Frame and Right Frame together with the screw. (Place the Right Frame on top of the Front Frame.)
- Secure the Head FFCs (x3) to the Front Frame with the acetate tape (x1) as shown in the figure below.

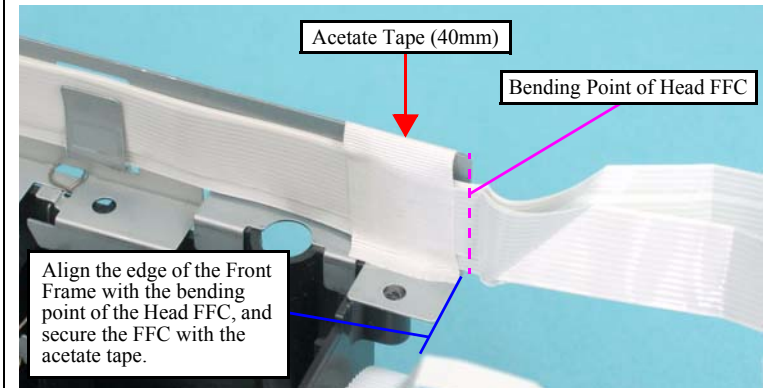


Figure 4-52. Acetate Tape Position

### 4.5.7 Star Wheel Holder Assy

- Parts/Components need to be removed in advance  
Document Cover/ASF Cover/Scanner Unit/Panel Unit/Upper Housing
- Removal procedure
  1. Remove the Grounding Spring from the Star Wheel Holder Assy.
  2. Remove the screws (x2) that secure the Star Wheel Holder Assy, and remove the Star Wheel Holder Assy.

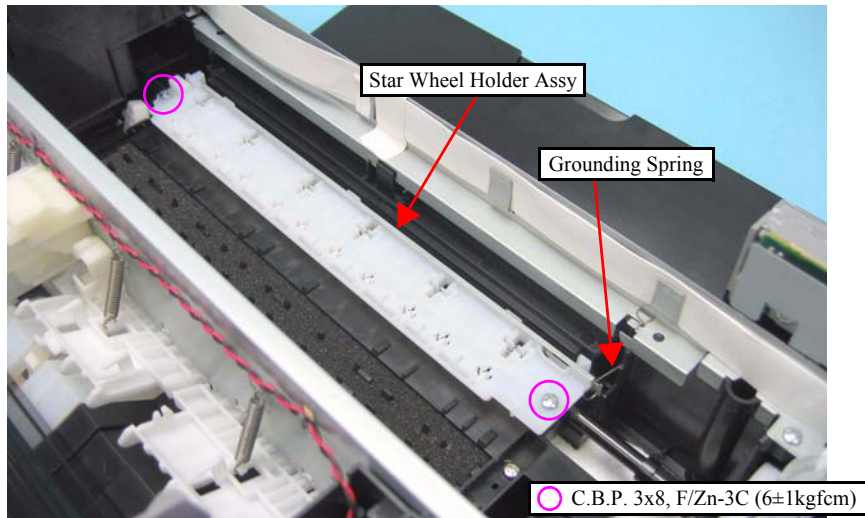


Figure 4-53. Removing the Star Wheel Holder Assy

### 4.5.8 EJ Roller

- Parts/Components need to be removed in advance  
Document Cover/ASF Cover/Scanner Unit/Panel Unit/Upper Housing/Card Slot Cover/Lower Housing/Main Board Unit/Left Frame/Star Wheel Holder Assy
- Removal procedure



**The Spur Gear 51.5 cannot be reused after it is removed. Whenever the gear is removed, make sure to attach a new one.**

1. Insert a flathead precision screwdriver between the Spur Gear 51.5 and the EJ Roller, and remove the Spur Gear 51.5 by pushing it in the direction of the arrow.

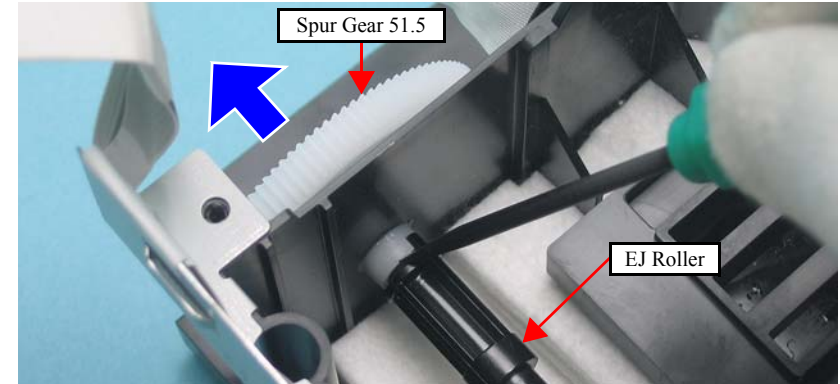


Figure 4-54. Removing the EJ Roller (1)

2. Remove the EJ Roller while pushing the tab on the right side of the Base Frame in the direction of the arrow.

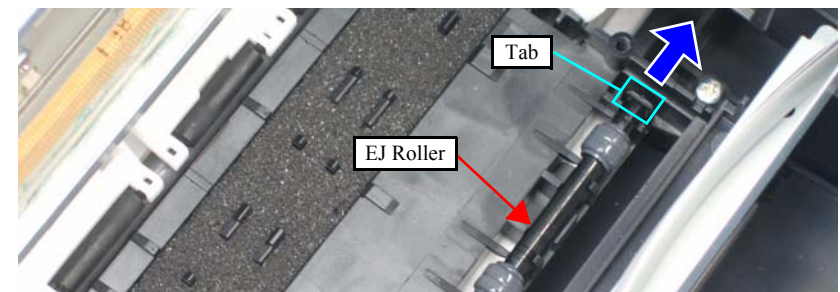


Figure 4-55. Removing the EJ Roller (2)



- When installing the EJ Roller, pay attention to the following instructions.
  - Make sure that the rubber part of the EJ Roller does not contact with the hook of the Front Paper Guide.
  - Be cautious not to touch the rubber part of the EJ Roller.
  - Be sure to align the rib (x1) of the Front Paper Guide with the slit on the EJ Roller.

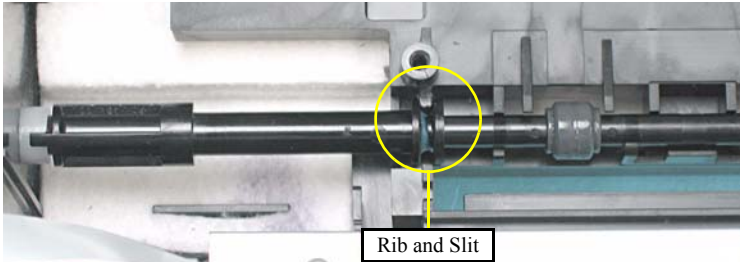


Figure 4-56. Installing the EJ Roller

- When installing the Spur Gear 51.5, be sure to align the concave section of it with the convex section of the EJ Roller.

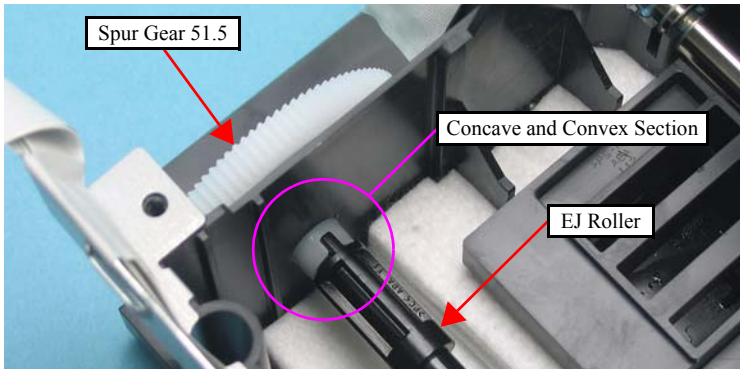


Figure 4-57. Installing the Spur Gear 51.5



- Whenever the EJ Roller is removed/replaced, the required adjustments must be carried out.
  - Chapter 5 “ADJUSTMENT” (p.141)
- After replacing the EJ roller, be sure to perform the required lubrication.
  - Chapter 6 “MAINTENANCE” (p.151)

## 4.5.9 PF Encoder Sensor

- Parts/Components need to be removed in advance  
Document Cover/ASF Cover/Scanner Unit/Panel Unit/Upper Housing/Card Slot Cover/Lower Housing/Main Board Unit/Left Frame
- Removal procedure
  1. Peel off the acetate tape (x1) from the PF Encoder Sensor.
  2. Release the PF Encoder FFC from the connector (x1) of the PF Encoder Sensor.
  3. Remove the screw (x1) that secures the PF Encoder Sensor, and remove the PF Encoder Sensor.

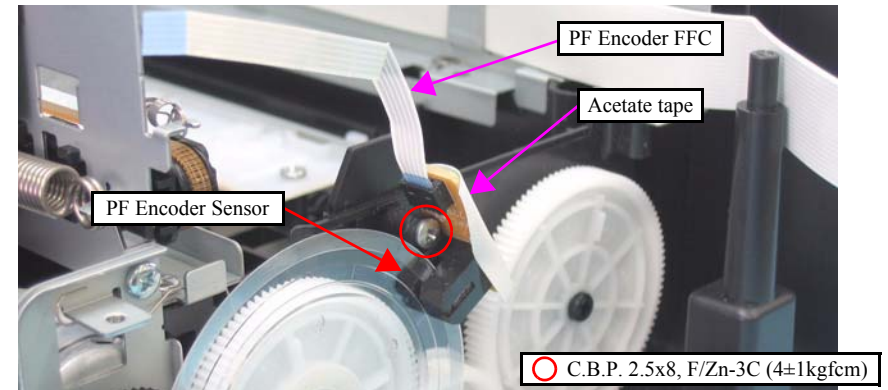


Figure 4-58. Removing the PF Encoder Sensor



When installing the PF Encoder Sensor, be sure to attach the acetate tape (x1) referring to the figure below.

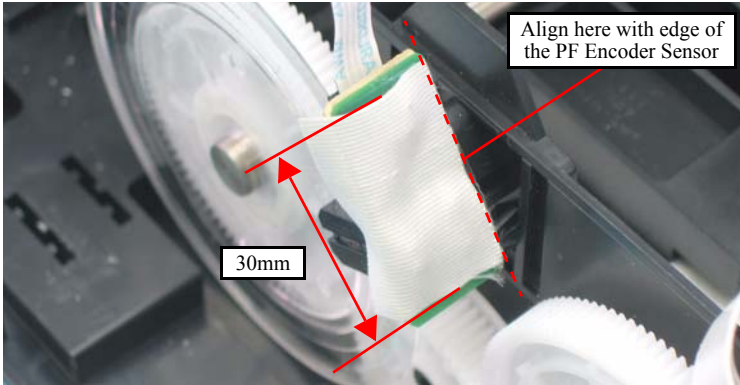


Figure 4-59. Acetate Tape Position

#### 4.5.10 PF Scale

- Parts/Components need to be removed in advance  
Document Cover/ASF Cover/Scanner Unit/Panel Unit/Upper Housing/Card Slot Cover/Lower Housing/Main Board Unit/Left Frame/PF Encoder Sensor
- Removal procedure



Pay attention to the following instructions.

- Do not touch the PF Scale with bare hand.
- Do not damage the PF Scale.

1. Peel of the PF Scale that is secured with the double-sided tape (x1) from the Spur Gear 32.4.

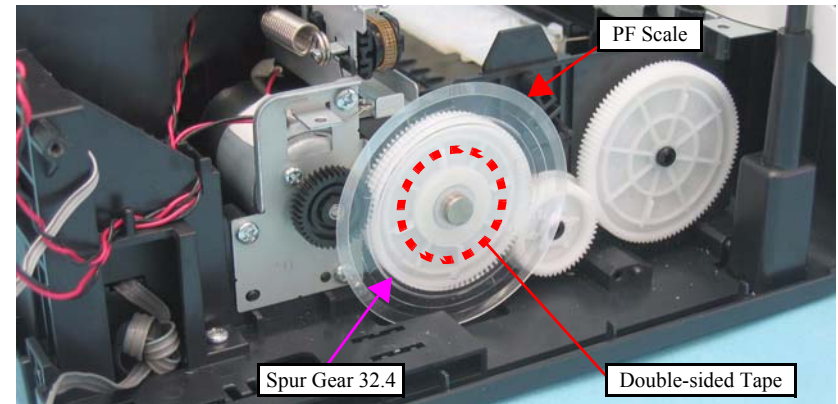


Figure 4-60. Removing the PF Scale

## 4.5.11 PF Motor

- Parts/Components need to be removed in advance

Document Cover/ASF Cover/Scanner Unit/Panel Unit/Upper Housing/Card Slot Cover/Lower Housing/Main Board Unit/Left Frame/PF Encoder Sensor/PF Scale

- Removal procedure

1. Release the PF Motor connector cable from the notches (x2) of the Base Frame.

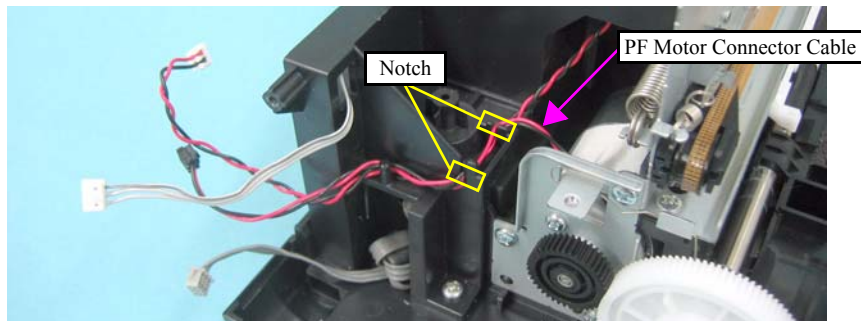


Figure 4-61. Removing the PF Motor (1)

2. Remove the Grounding Spring from the PF Motor.
3. Remove the screws (x3) that secure the PF Motor, and remove it.

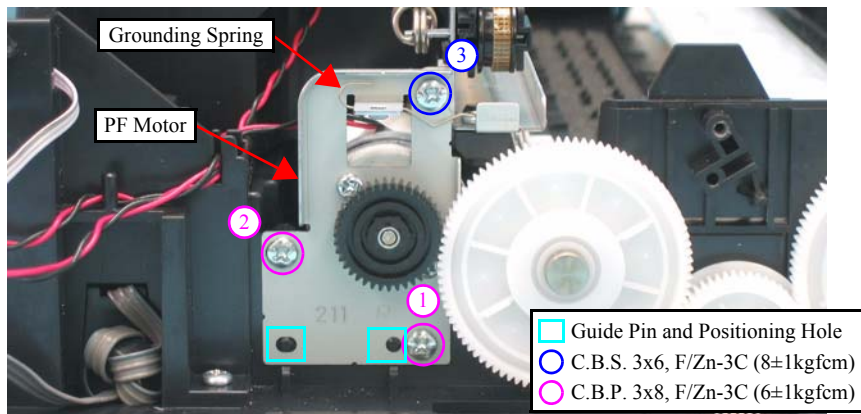


Figure 4-62. Removing the PF Motor (2)



- When installing the PF Motor, pay attention to the following instructions.

- Do not damage the PF Scale.
- Insert the guide pins (x2) on the Base Frame into the positioning holes (x2) of the PF Motor as shown in Figure 4-62.
- Route the PF Motor Connector Cable as shown in the figure below.

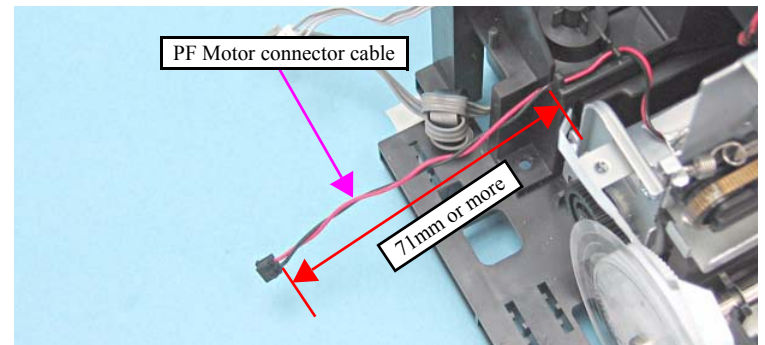


Figure 4-63. Routing the PF Motor Connector Cable

- Tighten the screws in the order given in Figure 4-62.
- Follow the steps below to install the Grounding Spring.
  1. Attach the larger U-shaped end of the Grounding Spring to the PF Roller.

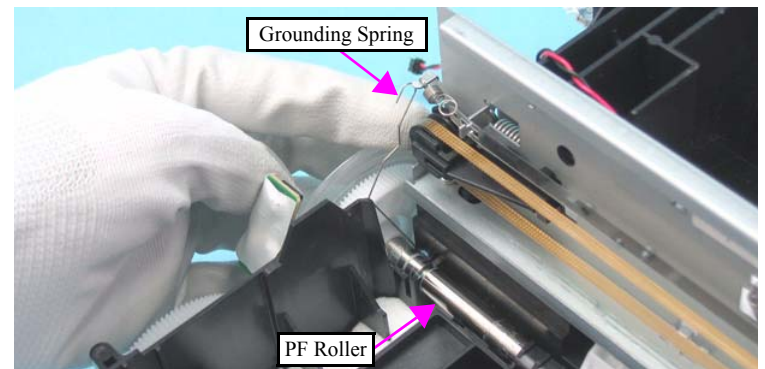


Figure 4-64. Installing the Grounding Spring (1)



2. Pass the Grounding Spring along the inner side of the hook of the Main Frame.
3. Ground the smaller U-shaped end of the Grounding Spring with the undersurface of the frame for PF Motor.

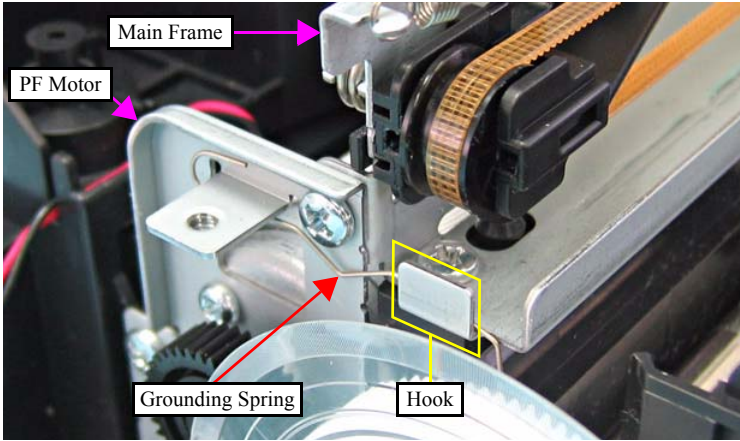


Figure 4-65. Installing the Grounding Spring (2)



Whenever the PF Motor is removed/replaced, the required adjustments must be carried out.

- Chapter 5 “ADJUSTMENT” (p.141)

## 4.5.12 CR Motor

- Parts/Components need to be removed in advance

Document Cover/ASF Cover/Scanner Unit/Panel Unit/Upper Housing/Card Slot Cover/Lower Housing/Main Board Unit/Left Frame/Front Frame/Right Frame

- Removal procedure

1. Turn the Spur Gear 51.5 to release the Carriage Lock, and move the CR Unit to the center.  
(Refer to 4.5.1 Printhead Step1 (p107))



Be careful not to damage the CR Motor cable when releasing the cable from the hooks of the Main Frame.

2. Release the CR Motor cable from the notches (x3) of the Base Frame and the hooks (x3) of the Main Frame, and then pull out the cable through the hole of the Base Frame.

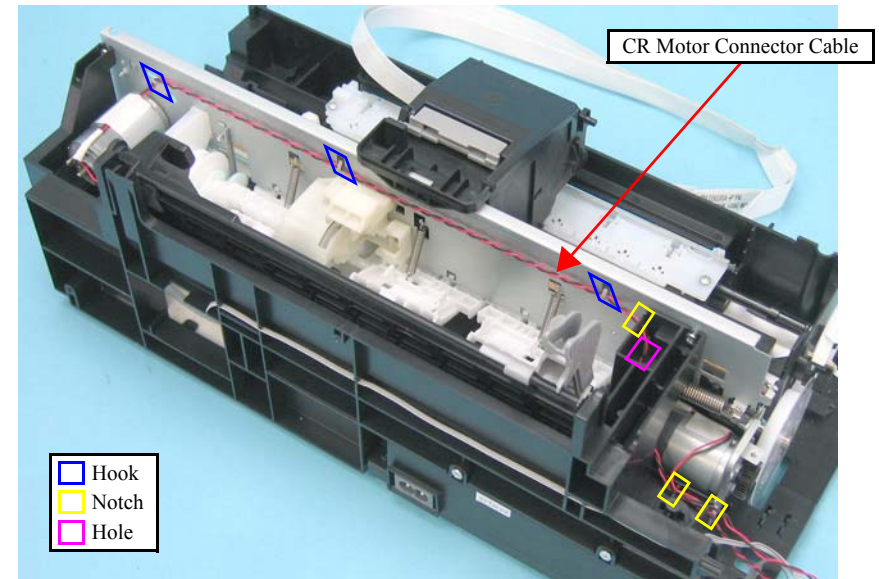


Figure 4-66. Removing the CR Motor (1)



**CAUTION**



After releasing the Timing Belt, temporarily secure the belt to the Cartridge Cover with a tape or the like so as not to allow the grease to come in contact with the Timing Belt. Contaminating the belt with grease can result in malfunction of the printer.

- Loosen the tension of the Timing Belt by pressing the Driven Pulley Holder in the direction of the arrow as shown in the figure, and release the Timing Belt from the pinion gear of the CR Motor.

**CAUTION**



Do not damage the pinion gear of the CR Motor.

- Remove the screws (x2) that secure the CR Motor, and remove the CR Motor.

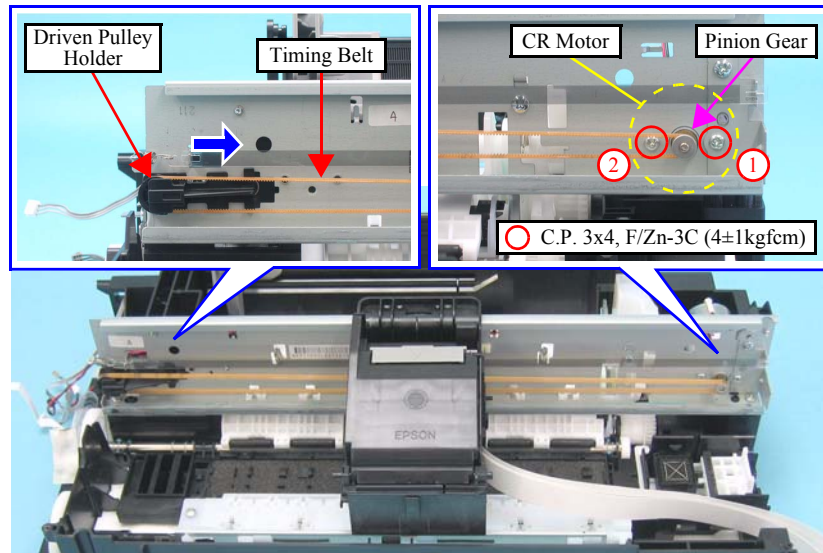


Figure 4-67. Removing the CR Motor (2)

**REASSEMBLY**



- Be sure to install the CR Motor so that the groove on it faces downward.

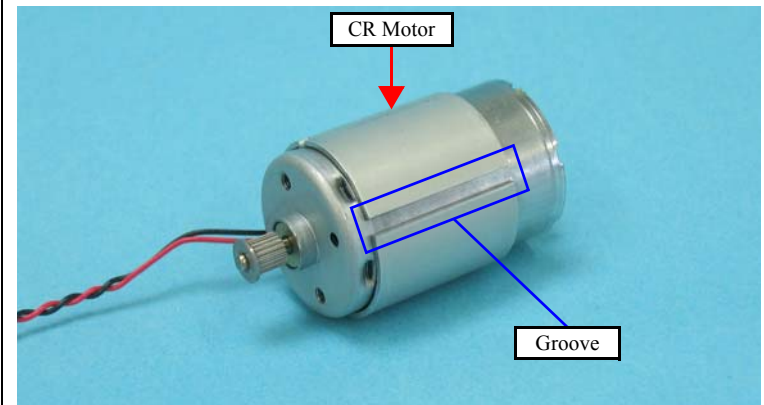


Figure 4-68. CR Motor

- Tighten the screws in the order given in [Figure 4-67](#).
- Make sure that there is no gap between the CR Motor and the Main Frame.

**ADJUSTMENT  
REQUIRED**



- Whenever the CR Motor is removed/replaced, the required adjustments must be carried out.
  - [Chapter 5 “ADJUSTMENT” \(p.141\)](#)

### 4.5.13 Main Frame Assy

- Parts/Components need to be removed in advance

Document Cover/ASF Cover/Scanner Unit/Panel Unit/Upper Housing/Card Slot Cover/Lower Housing/Main Board Unit/Left Frame/Front Frame/Right Frame/CR Motor/CR Scale/Hopper



Main Frame Assy consists of the following parts.

- Main Frame
- CR Unit
- Printhead
- Upper Paper Guide

- Removal procedure

1. Remove the Grounding Spring from the PF Motor.  
(Refer to 4.5.11 PF Motor Step2 (p119))
2. Release one end of the Extension Spring from the hook of the Main Frame with longnose pliers, and then remove the spring together with the Driven Pulley Holder.

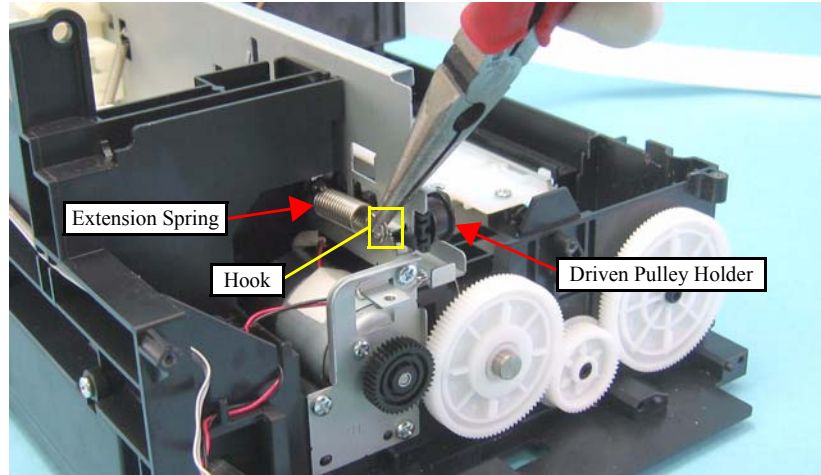


Figure 4-69. Removing the Extension Spring and Driven Pulley Holder

3. Move the CR Unit to the left side of the printer.
4. Remove the screw (x1) that secures the LD Shaft Holder.
5. Move the LD Shaft Holder in the direction of the arrow while holding down its tab with a flathead precision screwdriver, and remove the LD Shaft Holder.

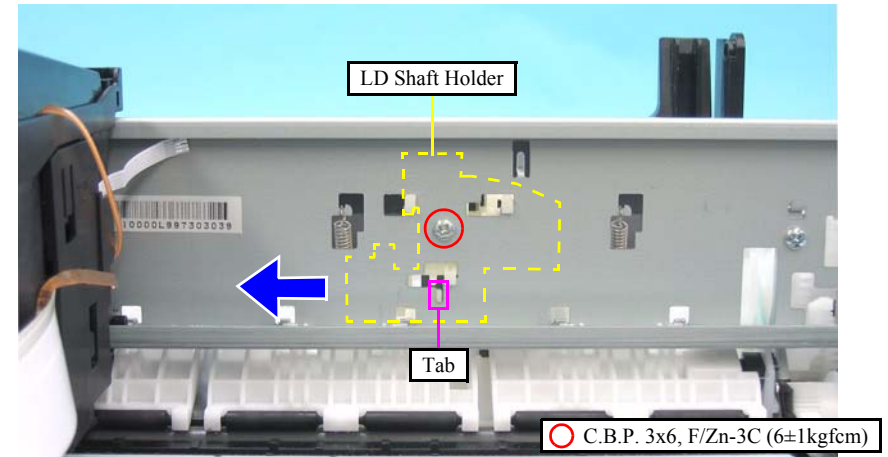


Figure 4-70. Removing the LD Shaft Holder

6. Remove the Extension Springs 10.99 (x3) from each hook of the Main Frame and the Upper Paper Guide.



Figure 4-71. Removing the Upper Paper Guide (1)

**CAUTION**



When laying the Main Frame Assy, make sure to put it as shown in the figure below. Do not lay it with the rollers of the Upper Paper Guide facing downward, or the rollers or the nozzle surface may get damaged.

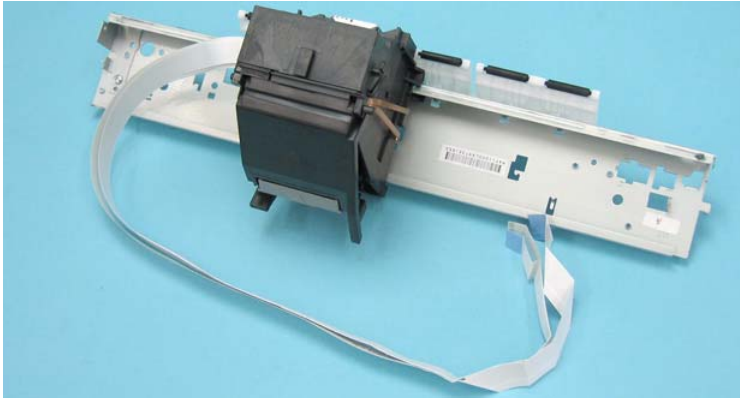


Figure 4-72. Precaution on Handling Main Frame Assy

- Remove the screws (x6) that secure the Main Frame, and remove it while avoiding the LD Roller Shaft so as not to hit the Upper Paper Guide.

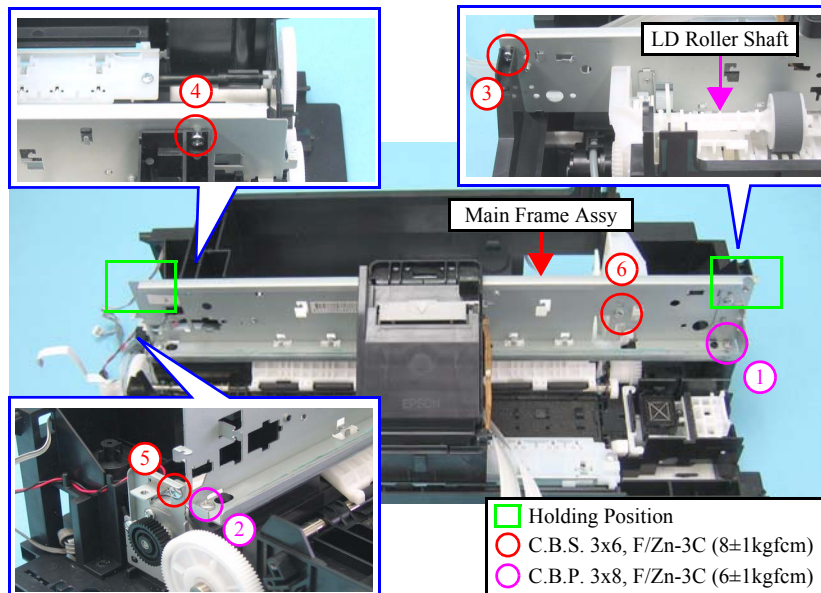


Figure 4-73. Removing the Main Frame Assy

**REASSEMBLY**



- When installing the Main Frame Assy, pay attention to the following instructions.

- Put the right part of the Upper Paper Guide under the LD Roller Shaft as shown in the figure below.
- Align the hook (x1) of the Frame Support with the positioning hole (x1) of the Main Frame.
- Align the hook (x1) of the ASF Unit with the positioning hole (x1) of the Main Frame.
- Align the guide pins (x2) of the Base Frame with the positioning holes (x2) of the Main Frame.

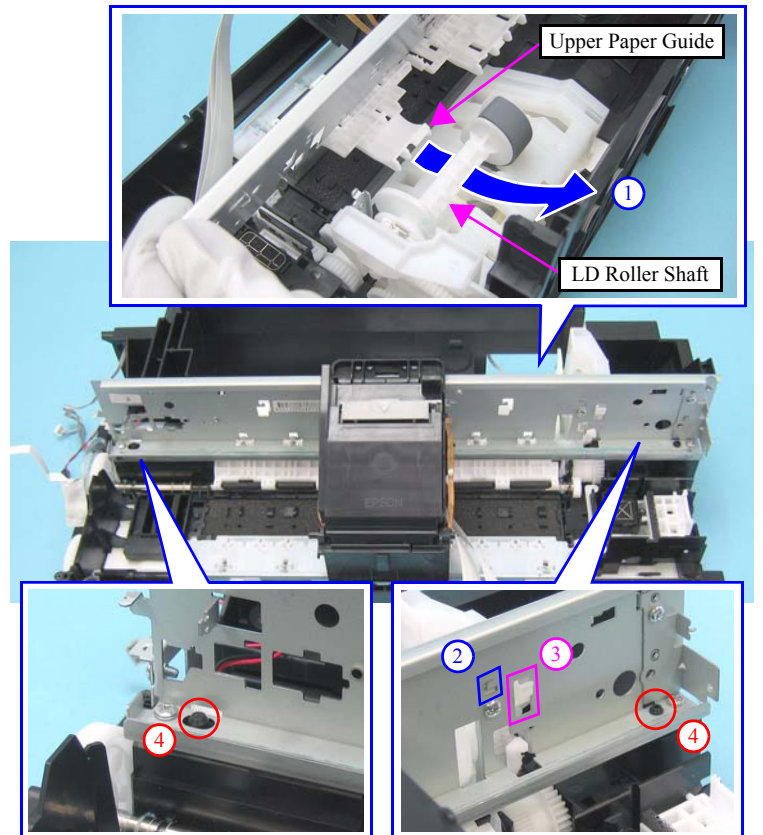


Figure 4-74. Main Frame Assy



- Tighten the screws in the order given in [Figure 4-73](#).
- Follow the steps below to install the Extension Spring 10.99 to the Upper Paper Guide.
  1. Attach the one end of the Extension Spring 10.99 to the hook of the Upper Paper Guide.
  2. Attach the other end of the Extension Spring 10.99 to the hook of the Main Frame with longnose pliers.

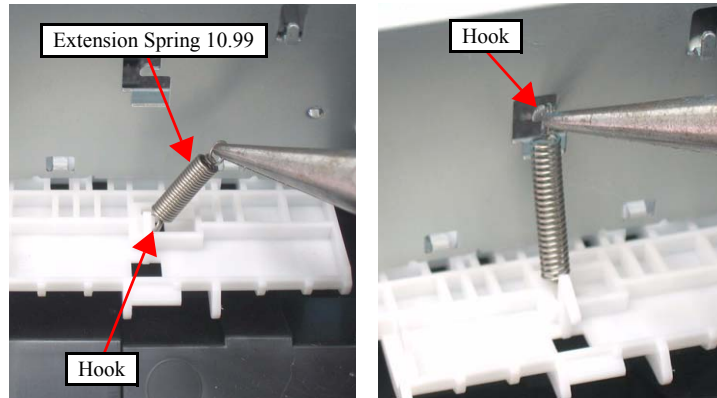


Figure 4-75. Installing the Extension Spring 10.99

- Be sure to install the Grounding Spring referring to [Figure 4-64](#) and [Figure 4-65](#).



- Whenever the Main Frame is removed/replaced, the required adjustments must be carried out.
  - [Chapter 5 “ADJUSTMENT” \(p.141\)](#)
- After replacing the Main Frame, be sure to perform the specified lubrication.
  - [Chapter 6 “MAINTENANCE” \(p.151\)](#)

#### 4.5.14 CR Unit

- Parts/Components need to be removed in advance  
Document Cover/ASF Cover/Scanner Unit/Panel Unit/Upper Housing/Card Slot Cover/Lower Housing/Main Board Unit/Left Frame/Front Frame/Right Frame/CR Motor/CR Scale/Hopper/Main Frame Assy/Printhead
- Removal procedure
  1. Remove the screw (x1) that secures the CR Scale Holder, and remove the CR Scale Holder.
  2. Move the CR Unit in the direction of the arrow to remove the CR Unit.

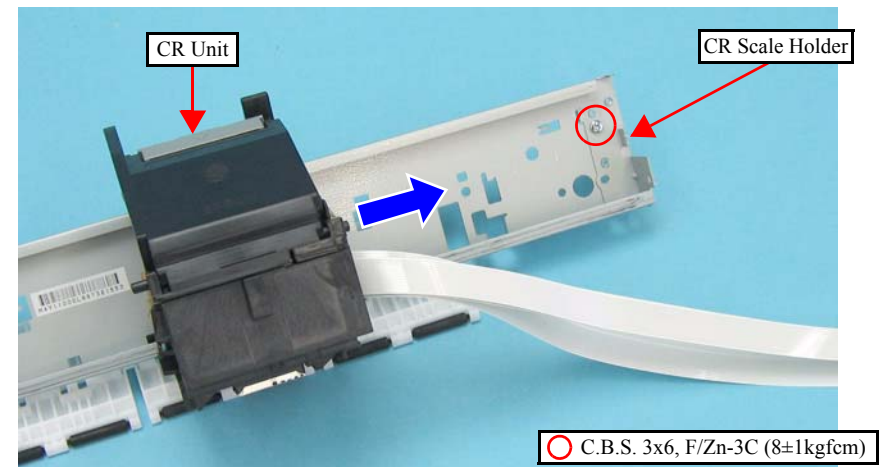


Figure 4-76. Removing the CR Unit (1)

3. Release the Timing Belt from the groove of the CR Unit.

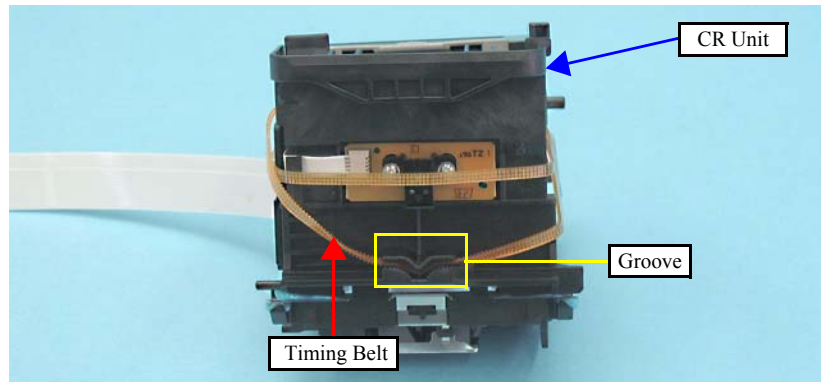


Figure 4-77. Removing the CR Unit (2)



- The Ink Position Label is not included in the ASP unit of the CR Unit. When replacing the CR Unit, order the Ink Position Label separately and attach the label on the specified place as shown in the figure below.

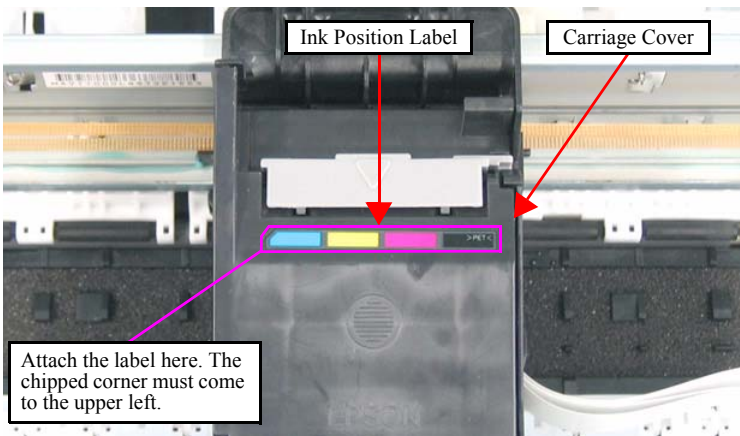


Figure 4-78. Attaching Ink Position Label



- Put the part of the Timing Belt toothed on its both sides into the groove of the CR Unit.

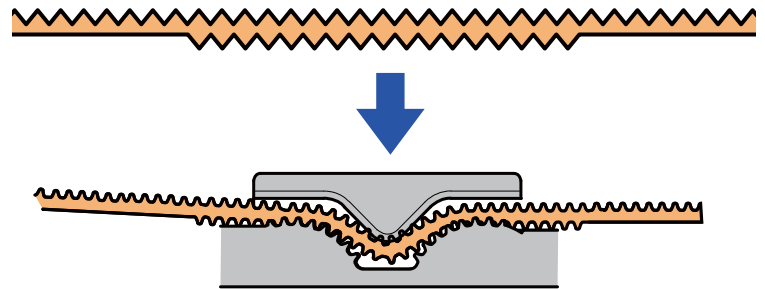


Figure 4-79. Installing the Timing Belt



- Whenever the CR Unit is removed/replaced, the required adjustments must be carried out.
  - Chapter 5 “ADJUSTMENT” (p.141)
- After replacing the CR Unit, be sure to perform the required lubrication.
  - Chapter 6 “MAINTENANCE” (p.151)

### 4.5.15 Upper Paper Guide

- Parts/Components need to be removed in advance  
Document Cover/ASF Cover/Scanner Unit/Panel Unit/Upper Housing/Card Slot Cover/Lower Housing/Main Board Unit/Left Frame/Front Frame/Right Frame/CR Motor/CR Scale/Hopper/Main Frame Assy
- Removal procedure
  1. Release the hooks (x6), and remove the Upper Paper Guide.

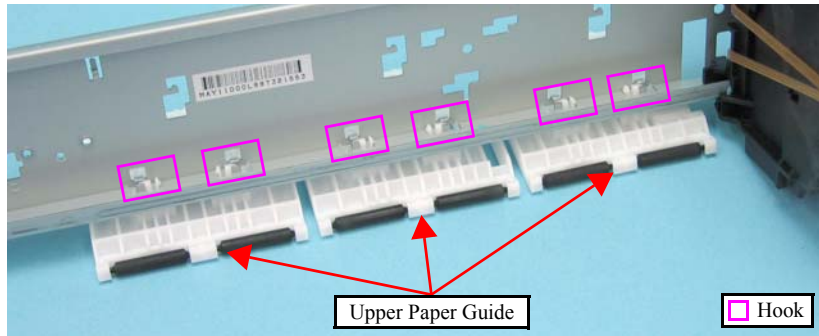


Figure 4-80. Removing the Upper Paper Guide (1)



When installing the Upper Paper Guide, attach the legs (x2) of the antistatic cloth into the holes (x2) of Upper Paper Guide as shown in the figure below.

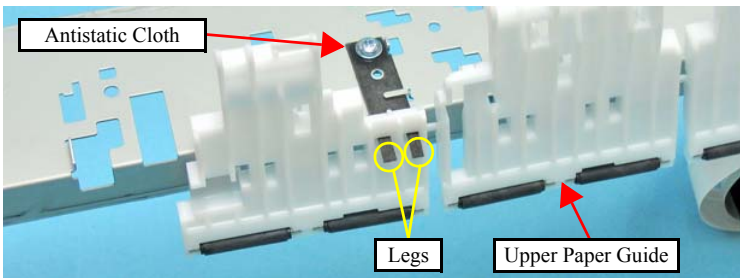


Figure 4-81. Installing the Upper Paper Guide



Whenever the Upper Paper Guide is removed/replaced, the required adjustments must be carried out.

- Chapter 5 “ADJUSTMENT” (p.141)

### 4.5.16 ASF Unit

- Parts/Components need to be removed in advance  
Document Cover/ASF Cover/Scanner Unit/Panel Unit/Upper Housing/Card Slot Cover/Lower Housing/Main Board Unit/Left Frame/Front Frame/Right Frame/CR Motor/CR Scale/Hopper/Main Frame Assy
- Removal procedure
  1. Release the PE Sensor cable from the notches (x6) of the Base Frame and pull out the cable from the hole (x1).

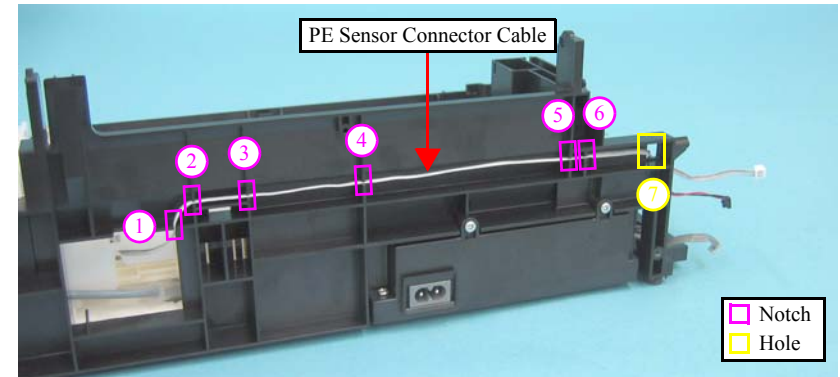


Figure 4-82. Releasing the PE Sensor Connector Cable



When performing the following steps, be cautious not to get injured with the sharp edges of the Frame Support.

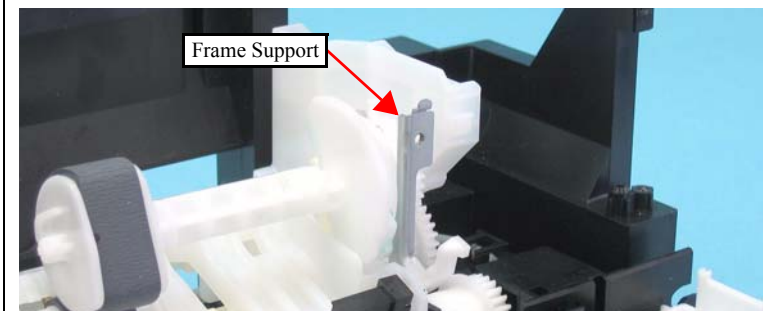


Figure 4-83. Sharp Edges of the Frame Support

2. Remove the screws (x2) that secure the ASF Unit.

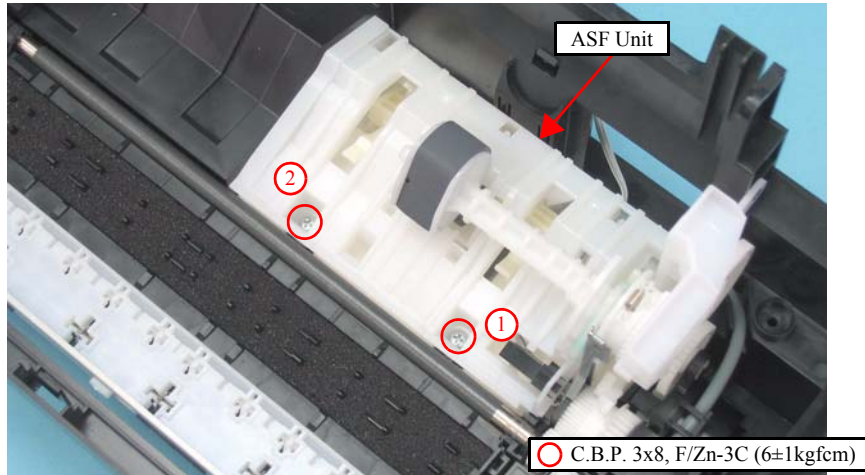


Figure 4-84. Removing the ASF Unit (1)

3. Release the dowel (x1) and guide pins (x2) of the Base Frame and the shaft (x1) of the ASF Unit, then remove the ASF Unit.

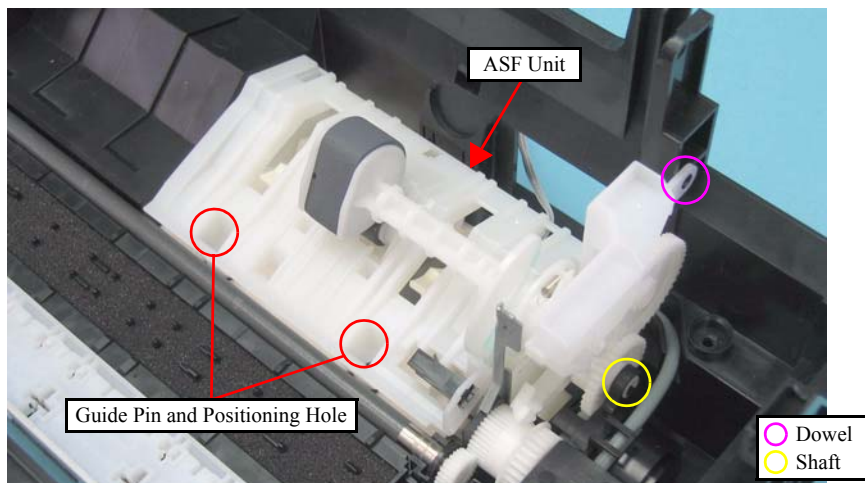


Figure 4-85. Removing the ASF Unit (2)



- When installing the ASF Unit, be sure to align the guide pins (x2) of the Base Frame with the positioning holes (x2) of the ASF Unit as shown in [Figure 4-85](#).
- Tighten the screws in the order given in [Figure 4-84](#).
- When routing the PE Sensor cable, pay attention to the following instructions.
  - Route the cable in the order given in [Figure 4-82](#).
  - Make sure to attach the cable with the blue line facing toward the Base Frame.

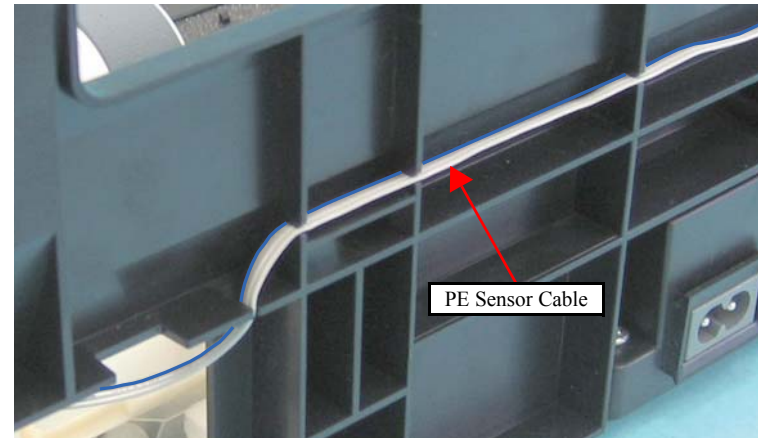


Figure 4-86. Routing PE Sensor Cable

- Check that the cable is tightly routed and there is no slack of it.



Whenever the ASF Unit is removed/replaced, the required adjustments must be carried out.

- [Chapter 5 “ADJUSTMENT” \(p.141\)](#)

## 4.5.17 Ink System Unit

- Parts/Components need to be removed in advance

Document Cover/ASF Cover/Scanner Unit/Panel Unit/Upper Housing/Card Slot Cover/Lower Housing/Main Board Unit/Left Frame/Front Frame/Right Frame/CR Motor/CR Scale/Hopper/Main Frame Assy/ASF Unit

- Removal procedure

**CAUTION**



When disassembling/assembling the Ink System Unit, pay attention to the following instructions.

- Be cautious not to get injured with the sharp edges of the Frame Support.

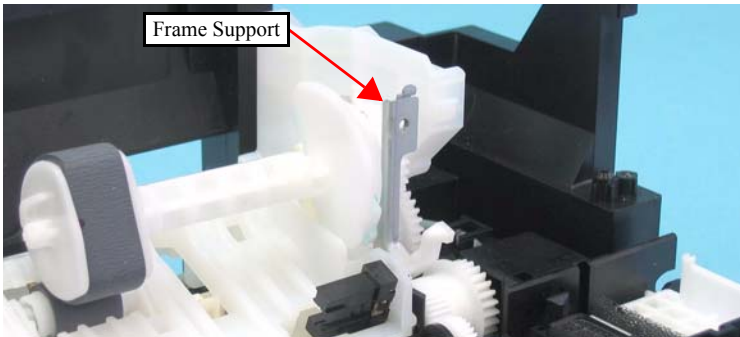


Figure 4-87. Sharp Edges of Frame Support

- Do not touch or damage the Sealing Rubber or the Head Cleaner.
- Mark the connecting point before removing the Ink Tube.

1. Detach the Waste Ink Tube together with the Tube Stopper from the Waste Ink Cover.
2. Detach the Waste Ink Tube from the groove of the Base Frame.

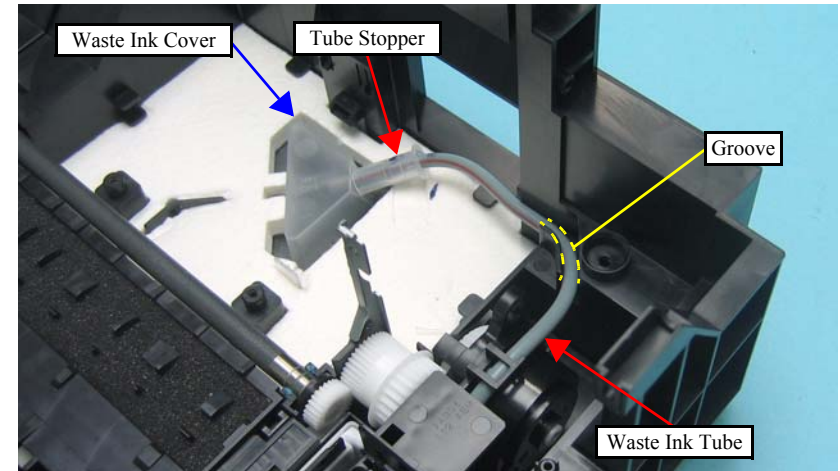


Figure 4-88. Detaching Waste Ink Tube

3. Remove the screw (x1) that secures the Ink System Unit.
4. Slide the Ink System Unit in the direction of the arrow while releasing the hook with a flathead precision screwdriver or a similar tool, and remove the Ink System Unit.

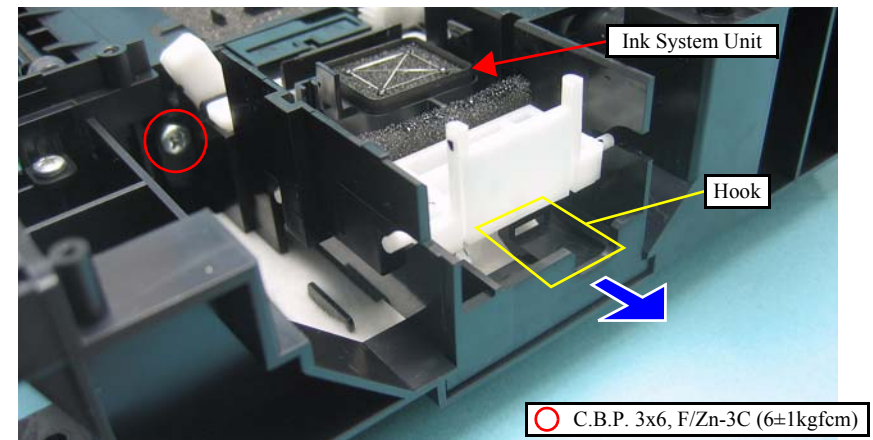


Figure 4-89. Removing the Ink System Unit





- If the Carriage lock lever comes off, reassemble it following the steps below.
  1. Attach the one end of the Extension Spring 0.8 to the hook of the Carriage Lock Lever.
  2. Attach the other end of the Extension Spring 0.8 to the Ink System Unit.
  3. Insert the dowel (x1) of the Carriage Lock Lever into the hole (x1) of the Ink System Unit.

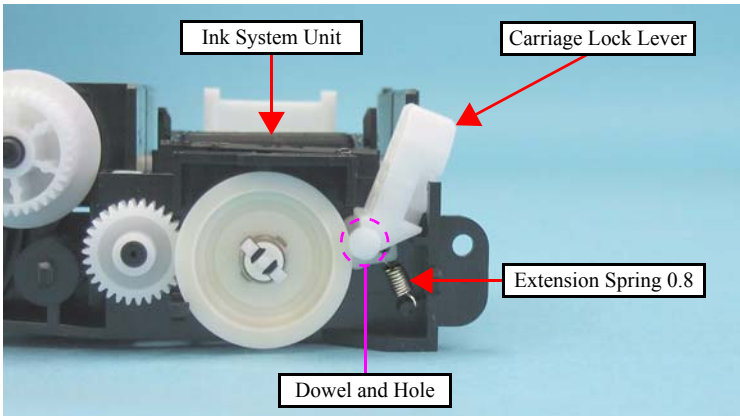


Figure 4-90. Installing the Carriage Lock Lever



- When installing the Ink System Unit, pay attention to the following instructions.
  - Align the dowels (x3) of the Ink System Unit with the positioning holes (x3) of the Base Frame.

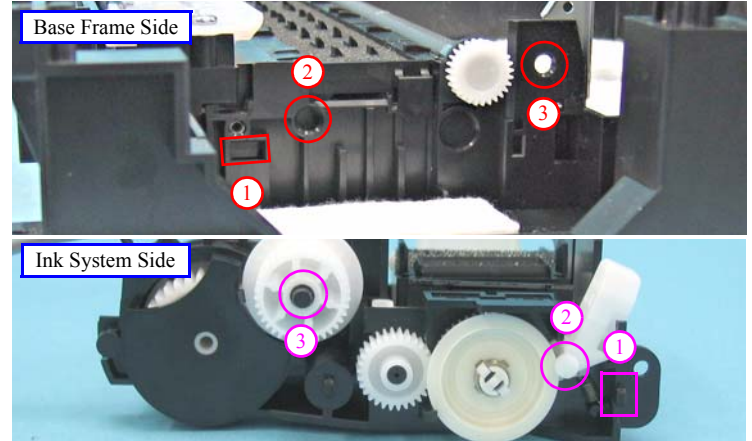


Figure 4-91. Installing the Ink System Unit (1)

- Align the ribs (x2) of the Ink System Unit with the grooves (x2) of the Base Frame.

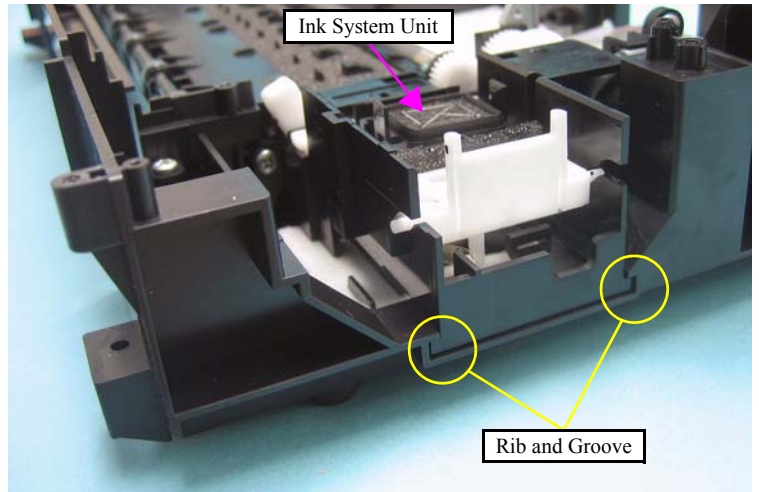


Figure 4-92. Installing the Ink System Unit (2)



- Route the Waste Ink Tube through the groove of the Base Frame so that the red line of the Waste Ink Tube faces to the Ink System Unit side.

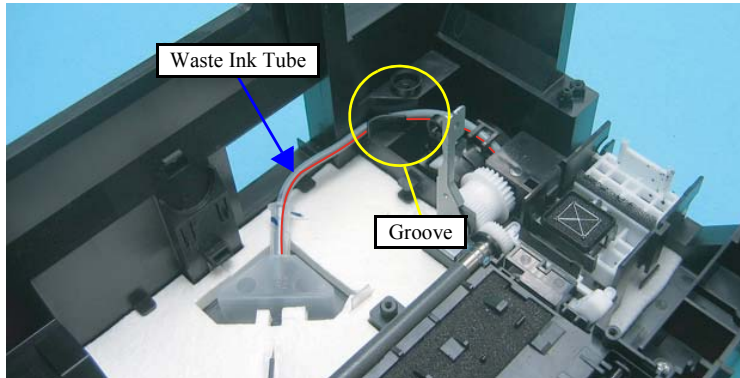


Figure 4-93. Routing the Waste Ink Tube

- Attach the Tube Stopper to the Waste Ink Tube as shown in the figure below, and insert them into the Waste Ink Cover.

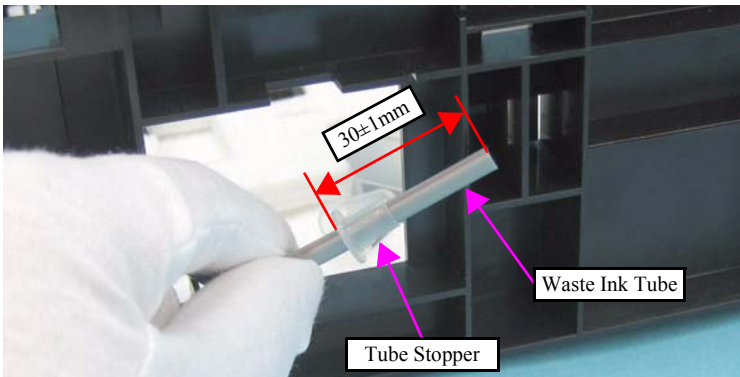


Figure 4-94. Installing the Waste Ink Tube

- When inserting the Waste Ink Tube into the Waste Ink Cover, make sure that there is no gap between the Tube Stopper and Waste Ink Cover.

## 4.5.18 Front Paper Guide

- Parts/Components need to be removed in advance

Document Cover/ASF Cover/Scanner Unit/Panel Unit/Upper Housing/Card Slot Cover/Lower Housing/Main Board Unit/Left Frame/Front Frame/Right Frame/CR Motor/CR Scale/Hopper/Main Frame Assy/ASF Unit/Ink System Unit/Star Wheel Holder Assy/EJ Roller

- Removal procedure



**When removing the Front Paper Guide, be cautious not to damage the ribs on the upper surface of the Front Paper Guide.**

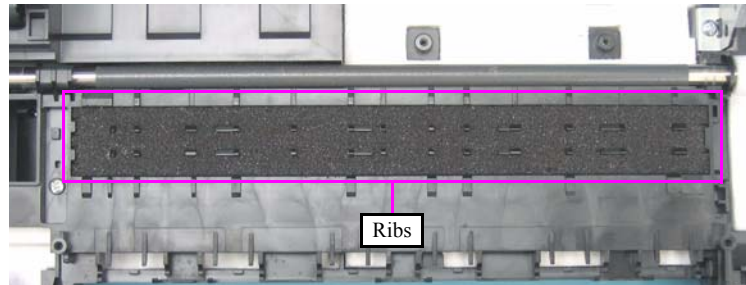


Figure 4-95. Ribs of the Front Paper Guide

1. Remove the screws (x2) that secure the Front Paper Guide.

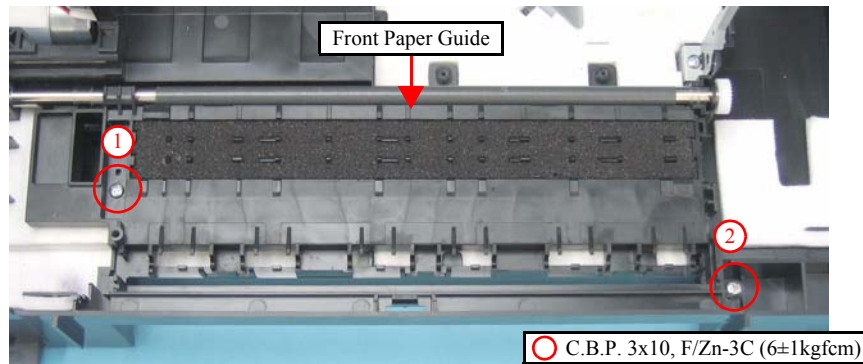


Figure 4-96. Removing the Front Paper Guide (1)

2. Release the hook (x1) of the Front Paper Guide, and remove the Front Paper Guide.

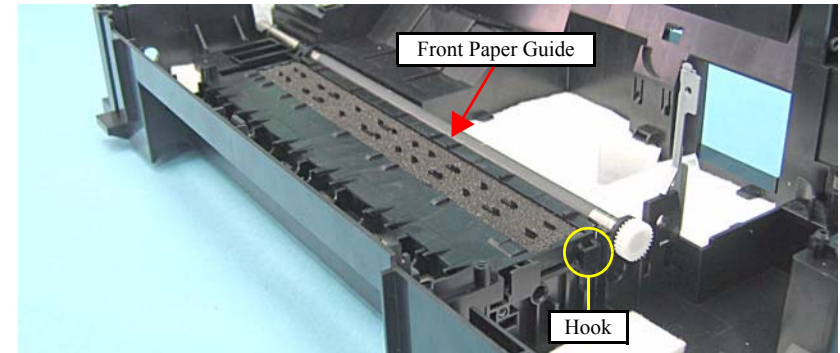


Figure 4-97. Removing the Front Paper Guide (2)



- When installing the Front Paper Guide, be cautious not to damage the PF Roller.
- Make sure that the tip of the PGF Pad is set in the correct position and confirm it is not caught between the Front Paper Guide and the Base Frame as shown in the figure below.

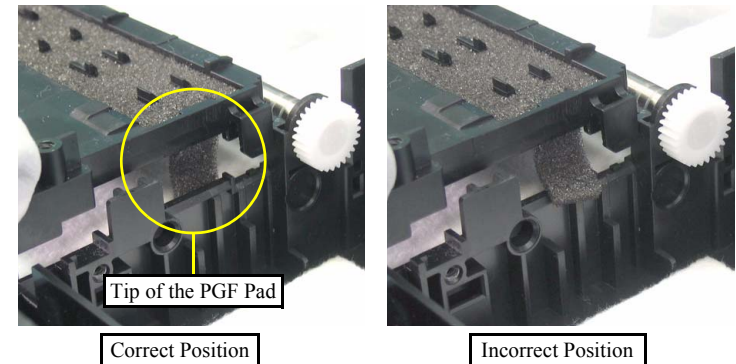


Figure 4-98. Installing the Front Paper Guide

- Tighten the screws in the order given in [Figure 4-96](#).



- Whenever the Front Paper Guide, is removed/replaced, the required adjustments must be carried out.
  - [Chapter 5 “ADJUSTMENT” \(p.141\)](#)
- After replacing the Front Paper Guide, be sure to perform the required lubrication.
  - [Chapter 6 “MAINTENANCE” \(p.151\)](#)

## 4.5.19 PF Roller

- Parts/Components need to be removed in advance

Document Cover/ASF Cover/Scanner Unit/Panel Unit/Upper Housing/Card Slot Cover/Lower Housing/Main Board Unit/Left Frame/Front Frame/Right Frame/CR Motor/CR Scale/Hopper/Main Frame Assy/ASF Unit/Ink System Unit/Star Wheel Holder Assy/EJ Roller/Front Paper Guide/PF Encoder Sensor/PF Scale

- Removal procedure



**When removing the PF Roller, be cautious not to touch or damage the coated surface of the PF Roller.**

1. Remove the Spur Gear 13.5 from the PF Roller with a flathead precision screwdriver or a similar tool.

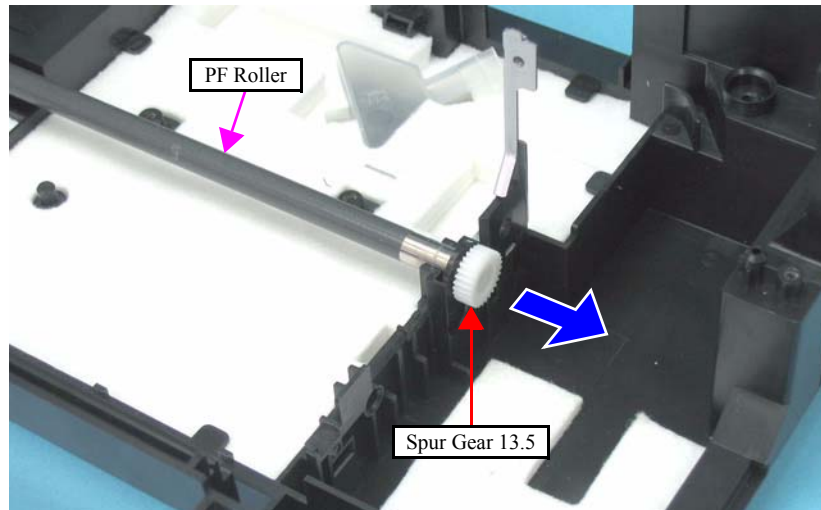


Figure 4-99. Removing the PF Roller (1)

2. Release the PF Roller from the cutout of the Base Frame (Step 2-1), and remove the PF Roller (Step 2-2).

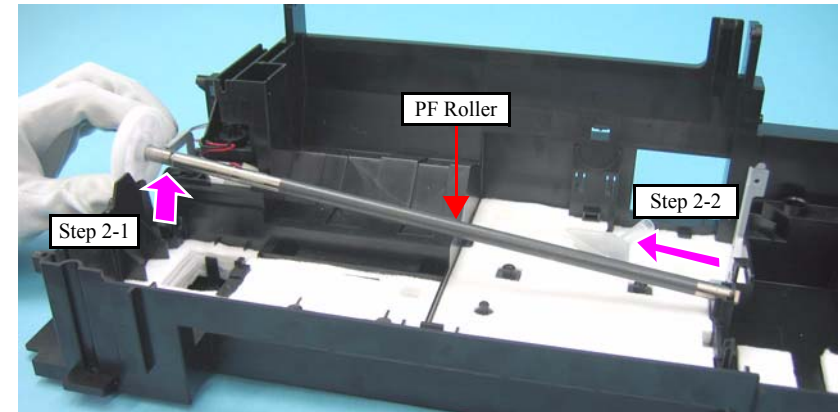


Figure 4-100. Removing the PF Roller (2)



**Whenever the PF Roller, is removed/replaced, the required adjustments must be carried out.**

- [Chapter 5 “ADJUSTMENT” \(p.141\)](#)
- After replacing the Front Paper Guide, be sure to perform the required lubrication.
- [Chapter 6 “MAINTENANCE” \(p.151\)](#)

## 4.5.20 Waste Ink Pads

- Parts/Components need to be removed in advance

Document Cover/ASF Cover/Scanner Unit/Panel Unit/Upper Housing/Card Slot Cover/Lower Housing/Main Board Unit/Left Frame/Front Frame/Right Frame/CR Motor/CR Scale/Hopper/Main Frame Assy/ASF Unit/Ink System Unit/Star Wheel Holder Assy/EJ Roller/Front Paper Guide/PF Encoder Sensor/PF Scale/PF Roller

- Removal procedure

1. Remove the Waste Ink Pads (x5) from the sections indicated with A to C of the Base Frame.

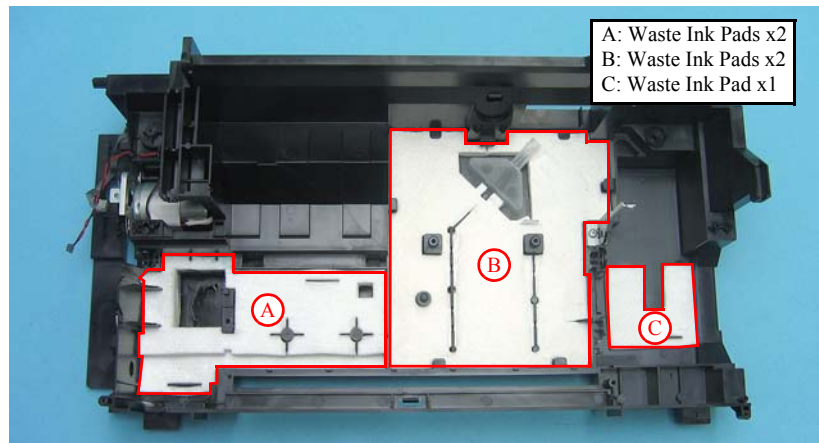


Figure 4-101. Removing the Waste Ink Pads

2. Remove the Waste Ink Cover and the Diffusion Sheet.

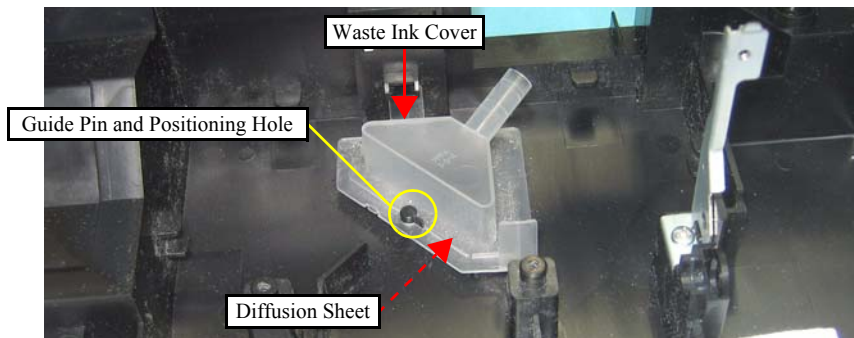


Figure 4-102. Removing the Waste Ink Cover and Diffusion Sheet



- When installing the Diffusion Sheet, Waste Ink Cover, and the Waste Ink Pads (x2) on section B, attach them in the order given in the figure below.

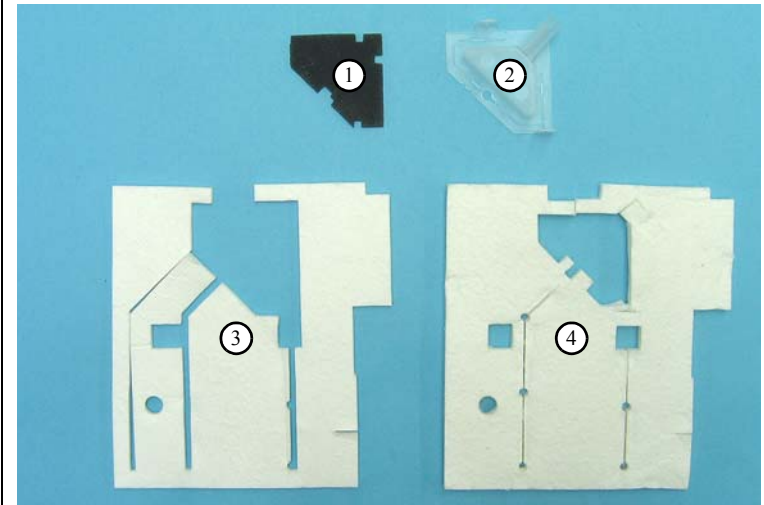


Figure 4-103. Installing the Waste Ink Pads

- When installing the Waste Ink Cover, be sure to align the guide pin (x1) of the Base Frame with the positioning hole (x1) of the Waste Ink Cover as shown in Figure 4-102. Make sure to confirm the cover is properly secured on the Diffusion Sheet without any gap.



Whenever the Waste Ink Pads is removed/replaced, the required adjustments must be carried out.

- [Chapter 5 “ADJUSTMENT” \(p.141\)](#)

## 4.6 Disassembling the Scanner Unit

### 4.6.1 Upper/Front Scanner Housing

□ Parts/Components need to be removed in advance

Document Cover/ASF Cover/Scanner Unit

□ Removal procedure

■ Upper Scanner Housing



- Following work should be performed in a room where there is a little dust. A clean room or a clean bench would be preferable.
- Do not scratch the Rod Lens Array when removing the CIS Assy.



If the Hinge R or the Driven Pulley comes off during disassembling, reassemble them as shown in the figure below.

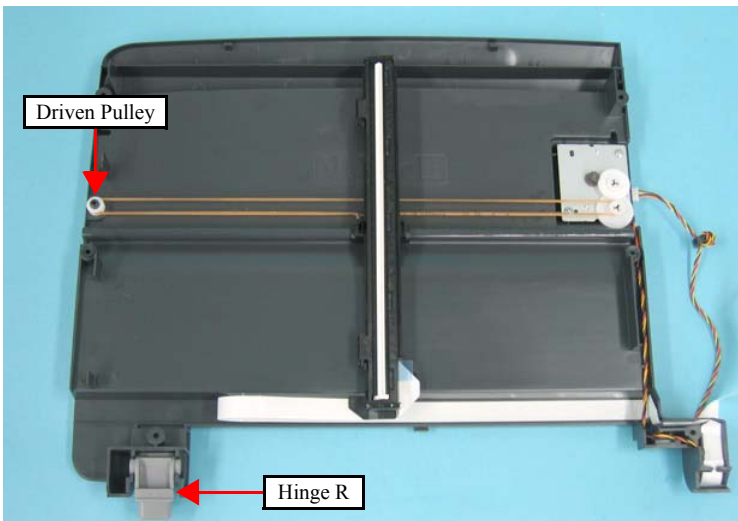


Figure 4-104. Installing the Hinge R or the Driven Pulley

1. Remove the screws (x6) that secure the Upper Scanner Housing, and release the two hooks inside the Lower Scanner Housing, then remove the Upper Scanner Housing by lifting the front of it.

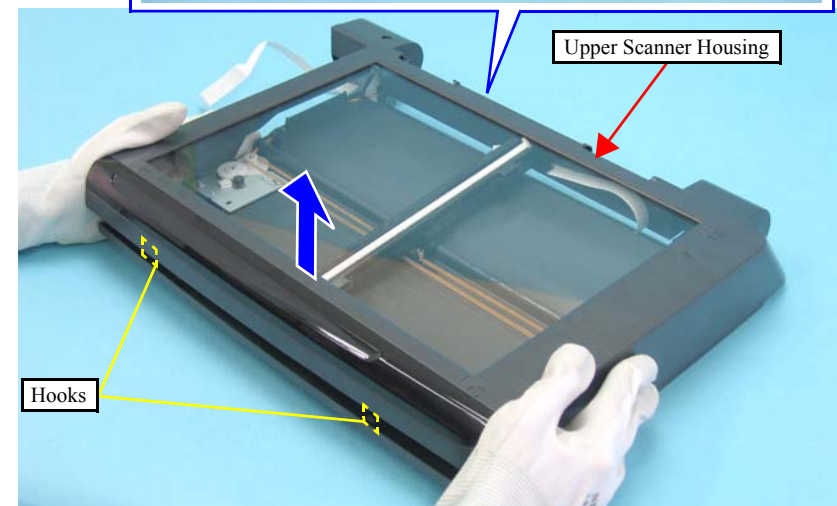


Figure 4-105. Removing the Upper Scanner Housing



When installing the Upper Scanner Housing, attach the Hinge R to the place as shown in [Figure 4-104](#).

■ Front Scanner Housing

1. Remove the Upper Scanner Housing toward you. (p134)
2. Release the hooks at the bottom of the Upper Scanner Housing, and remove the Front Scanner Housing.

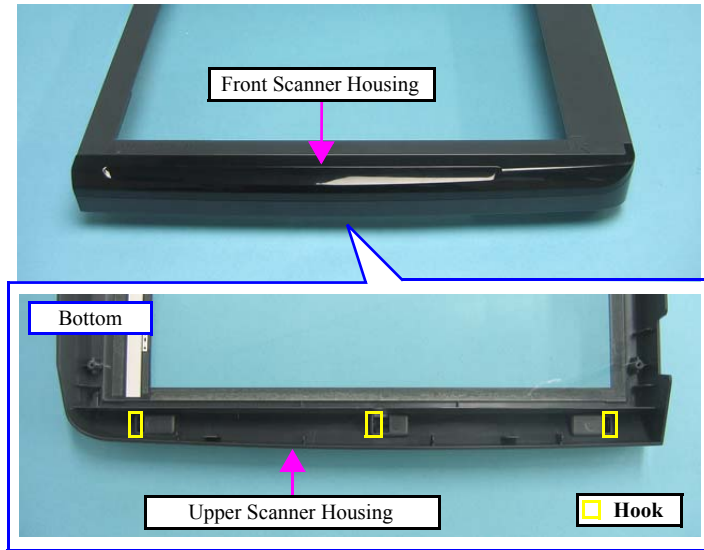


Figure 4-106. Removing the Front Scanner Housing

## 4.6.2 Scanner Carriage Unit

- Parts/Components need to be removed in advance

Document Cover/ASF Cover/Scanner Unit/Upper Scanner Housing

- Removal procedure



**Do not scratch the Rod Lens Array when removing the Scanner Carriage Unit.**

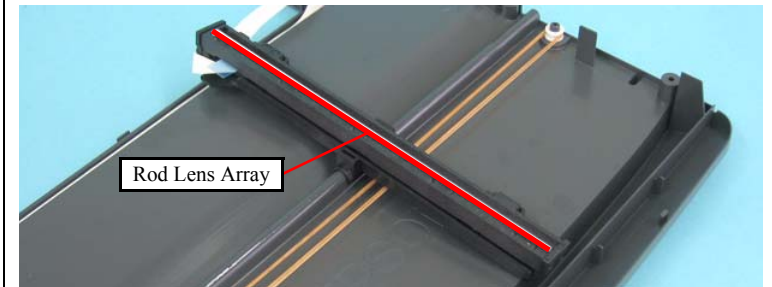


Figure 4-107. Handling the Scanner Carriage Unit

1. Move the Scanner Carriage Unit to the center.

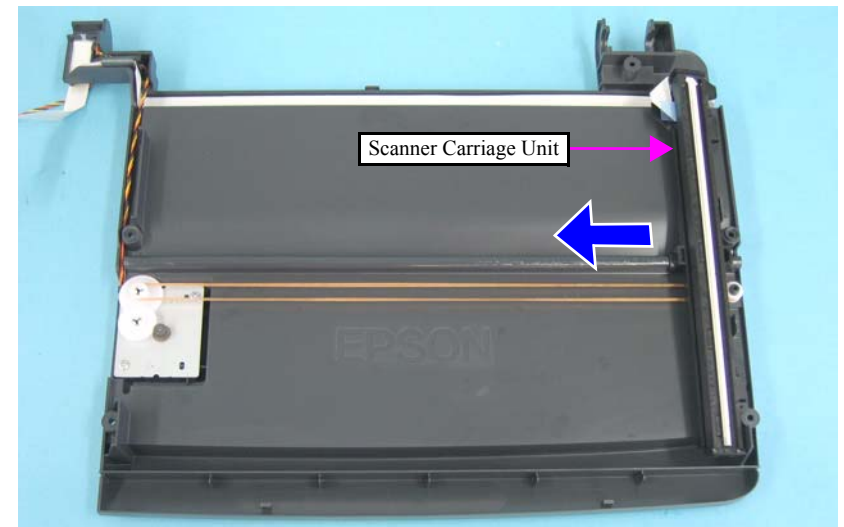


Figure 4-108. Moving the Scanner Carriage Unit

**CAUTION**



Take extra care not to contaminate the Scanner Timing Belt with grease on the rail of the Lower Scanner Housing.

2. Release the Pulley from the Lower Scanner Housing, and release the Scanner Timing Belt from the Combination Gear 22.8, 7.762 and the Driven Pulley.

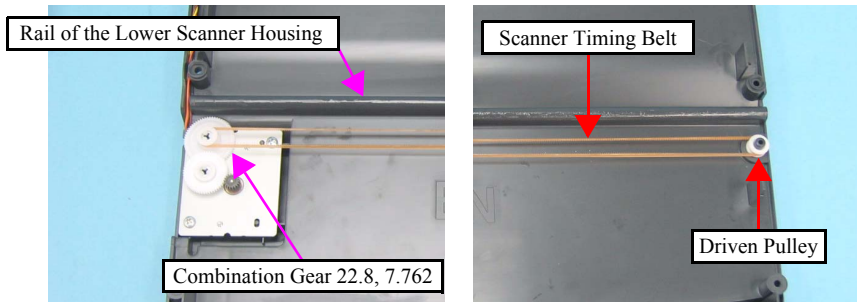


Figure 4-109. Removing the Scanner Carriage Unit (1)

**CAUTION**



Be careful about the double-sided tape fixing the Scanner Carriage FFC.

3. Release the Scanner Carriage FFC from the Scanner Carriage Unit, and remove the Scanner Carriage Unit together with the Scanner Timing Belt.

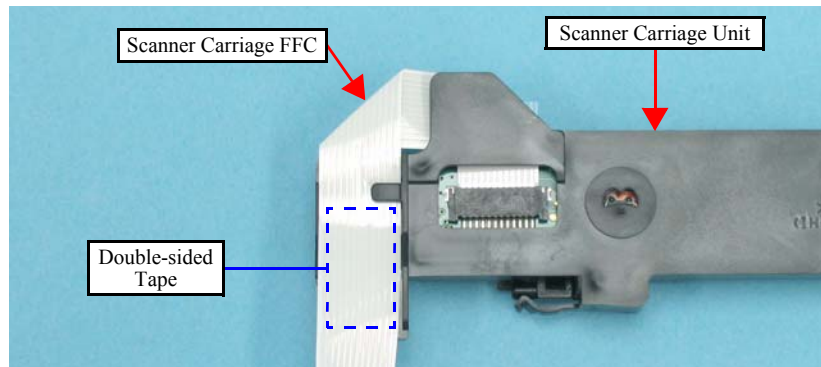


Figure 4-110. Removing the Scanner Carriage Unit (2)

4. Release the tabs (x2) from the hooks (x2) on the Scanner CR Holder and remove the CIS Unit.

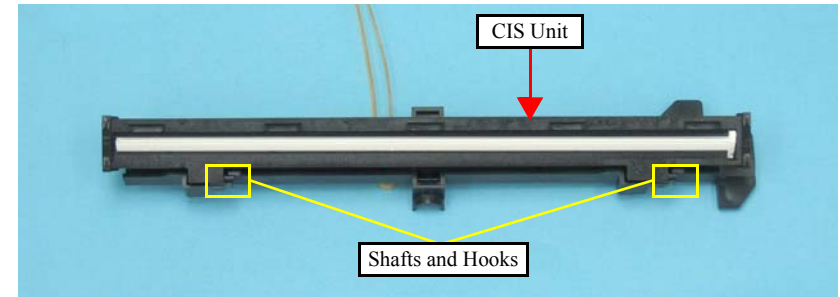


Figure 4-111. Removing the CIS Unit

5. Remove the CIS Springs (x2) from the Scanner CR Holder.

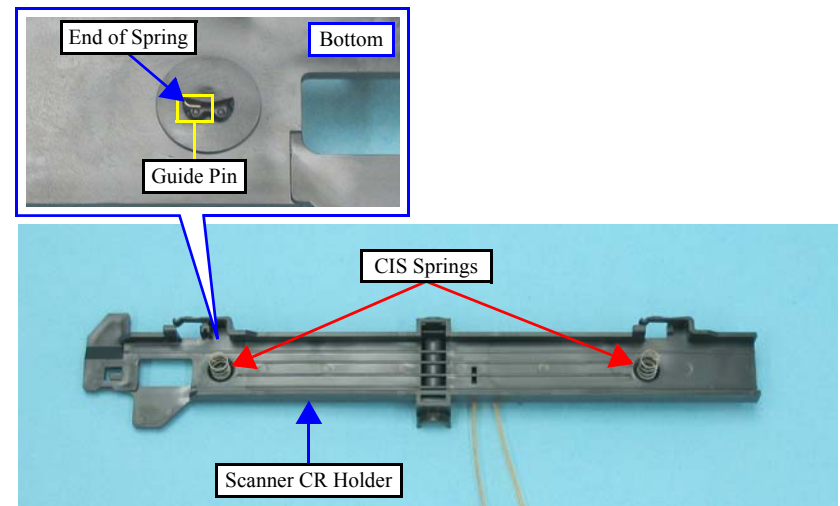


Figure 4-112. Removing the CIS Springs



6. Remove the Scanner Timing Belt together with the Torsion Spring from the Scanner CR Holder.

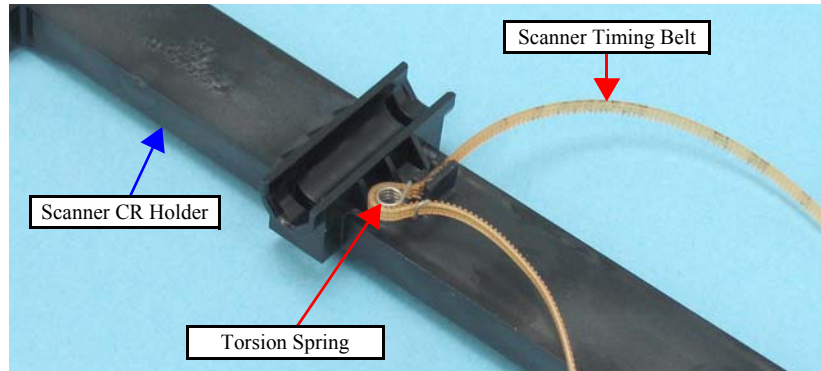


Figure 4-113. Removing the Scanner Timing Belt and Torsion Spring



- When installing the Scanner Timing Belt, attach the Torsion Spring as shown in [Figure 4-113](#).
- When installing the CIS Springs (x2), attach each end to their positioning tabs (x1 each) of the Scanner CR Holder as shown in [Figure 4-112](#).
- When replacing the CIS Unit, be sure to replace the spacers on both ends. Check the label on the CIS Unit and select the corresponding Spacers as shown below.
  - Label A: cis, A17 Spacer
  - Label B: cis, B19 Spacer
  - Label C: cis, C21 Spacer

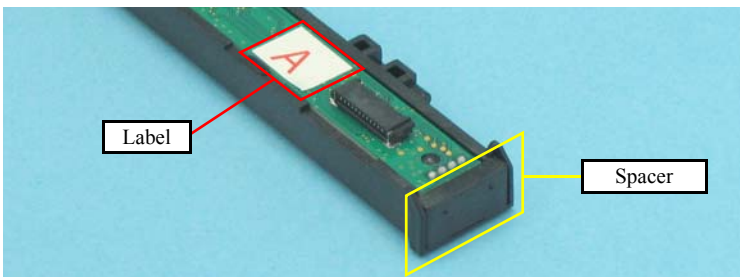


Figure 4-114. Replacing the Spacers

### 4.6.3 Scanner Motor Unit

- Parts/Components need to be removed in advance

Document Cover/ASF Cover/Scanner Unit/Upper Scanner Housing

- Removal procedure

1. Move the Scanner Carriage Unit to the center.  
(Refer to 4.6.2 Scanner Carriage Unit Step1 (p135))
2. Release the Driven Pulley from the Lower Scanner Housing, and release the Scanner Timing Belt from the Combination Gear 22.8, 7.762 and the Driven Pulley.  
(Refer to 4.6.2 Scanner Carriage Unit Step2 (p136))
3. Pull out the ferrite core through the opening (1), and release the Scanner Motor cable from the hooks of the Lower Scanner Housing.
4. Remove the two screws that secure the Scanner Motor Unit and remove the Scanner Motor Unit.

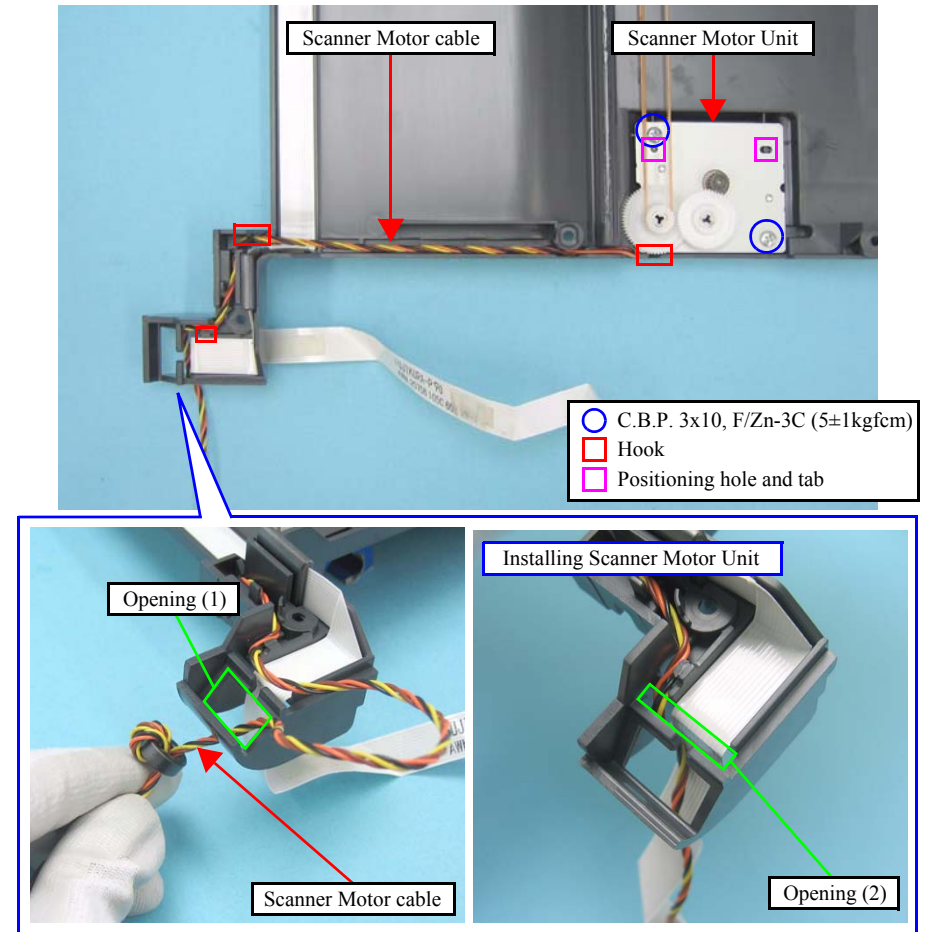


Figure 4-115. Removing the Scanner Motor Unit



- When installing the Scanner Motor Unit, match the positioning holes (x2) of the Scanner Motor Unit with their positioning tabs (x2) of the Lower Scanner Housing as shown in Figure 4-115.
- When routing the Scanner Motor cable, place the ferrite core in the opening (1) after leading the Scanner Motor cable through the opening (2) as shown in Figure 4-115.

## 4.7 Differences in Disassembling/Reassembling Stylus CX7300/TX200 series

This section explains the differences in disassembling/reassembling CX7300/TX200 series.

### 4.7.1 Panel Unit (CX7300/TX200 series)

- Parts/Components need to be removed in advance: None
- Removal procedure

1. Open the Scanner Unit.



**Do not lift the Panel Unit too fast, since the Panel FFC is connected to it.**

2. Lifting the front of the Panel Unit, and release the tabs of it.
3. Slide the Panel Unit in the direction of the arrow, and release the hooks of it from the Upper Housing.

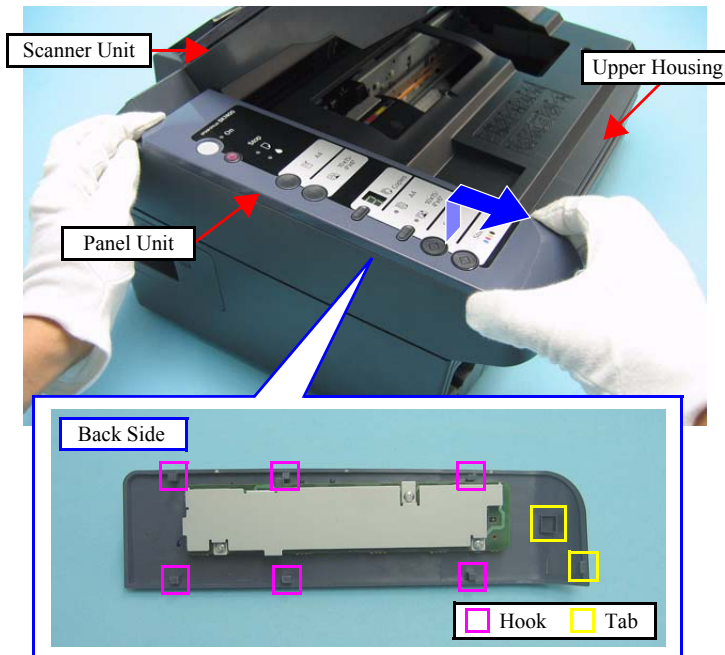


Figure 4-116. Removing the Panel Unit (1)



**Be sure to disconnect the Panel FFC from the connector on the Panel Board.**

4. Disconnect the Panel FFC from the connector (CN1) of the Panel Board, and remove the Panel Unit.

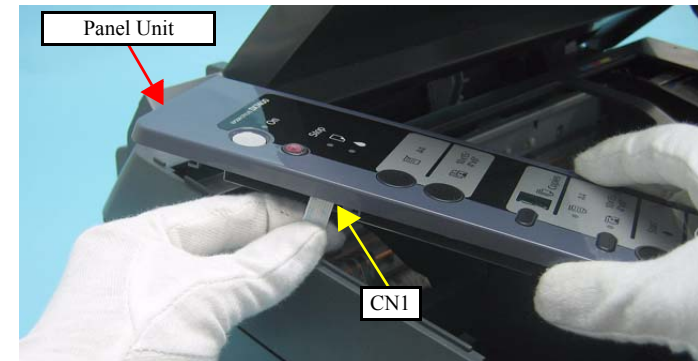


Figure 4-117. Removing the Panel Unit (2)

5. Remove the screws (x3) that secure the Panel Board and the Panel Board Frame, and remove the Panel Board Frame.

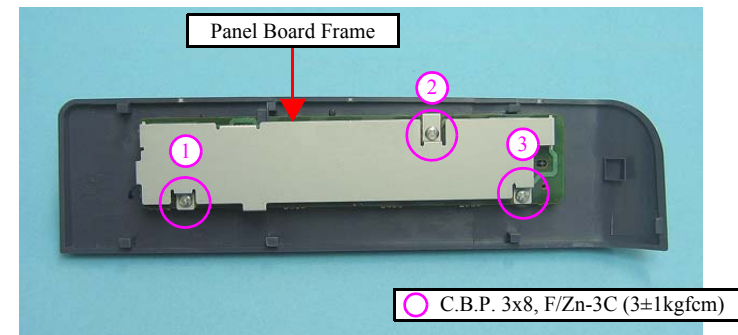


Figure 4-118. Removing the Panel Board Frame

6. While avoiding the rib of the Panel Housing, remove the Panel Board.

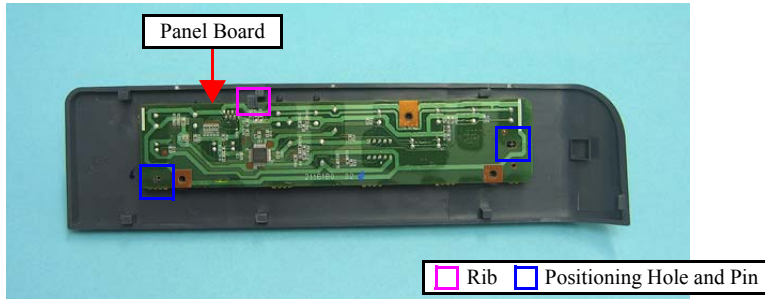


Figure 4-119. Removing the Panel Board

7. Remove the Power SW Button and the Switch Button from the Panel Cover.

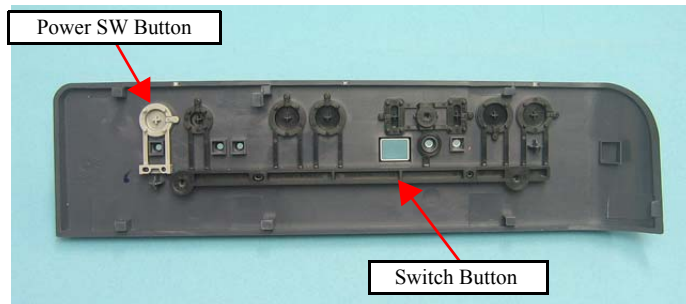


Figure 4-120. Removing the Switch Button



- When installing the Panel Board, match the positioning holes (x2) of the Panel Board with their positioning pins (x2) of the Panel Housing as shown in Figure 4-119.
- Tighten the screws in the order given in Figure 4-118.
- The Panel Sheet is not included in the ASP unit of the Panel Unit. When replacing the Panel Unit, order the Panel Sheet separately and attach it on the specified place as shown in the figure below.

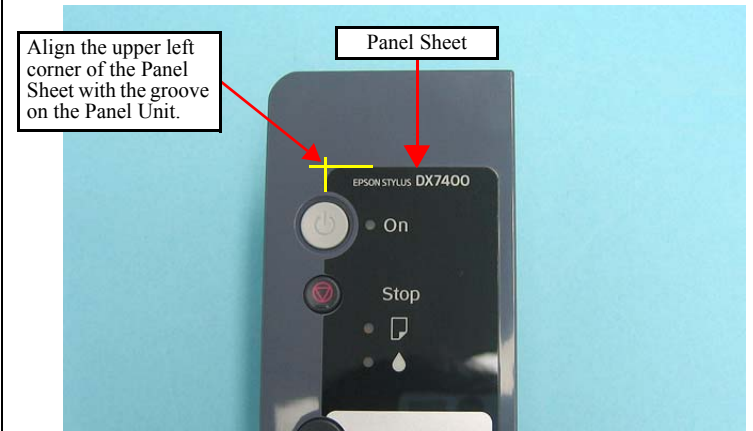


Figure 4-121. Panel Sheet Position

CHAPTER

5

**ADJUSTMENT**

## 5.1 Adjustment Items and Overview

This chapter describes adjustments required after the disassembly/reassembly of the printer.

### 5.1.1 Servicing Adjustment Item List

The adjustment items of this product are as follows.



For information on how to carry out the adjustments and media required for the adjustments, see the instructions displayed by the Adjustment Program.

Table 5-1. Adjustment Items

Adjustment Item	Purpose	Method Outline	Tool
EEPROM data copy	When the main board needs to be replaced, use this to copy adjustment values stored on the old main board to the new board. If this copy is completed successfully, all the other adjustments required after replacing the main board are no longer necessary.	Readout the EEPROM data from the main board before removing it. Then replace the board with a new one, and load the EEPROM data to the new board.	• Adjustment Program
Initial setting	This must be carried out after replacing the main board to apply settings for the target market.	Select the target market. The selected market settings are automatically written to the main board.	• Adjustment Program
USB ID input	This sets a USB ID of the printer. A computer identifies the printer by the ID when multiple same models are connected via a USB hub.	Enter the product serial number of the printer. The ID is automatically generated and written to the main board.	• Adjustment Program
Head ID input	This must be carried out after replacing the Printhead in order to enter the new Printhead ID (Head ID) that reduces variation between Printheads.	Enter the ID printed on the Head QR code label attached on the Printhead. The correction values are automatically written to the main board.	• Adjustment Program
TOP margin adjustment	This corrects top margin of printout.	A top margin adjustment pattern is printed. Examine the lines printed near the top edge of the printout, and enter the value for the line that is exactly 3 mm away from the top edge.	• Adjustment Program • Ruler
First dot position adjustment	This corrects left margin of printout. The print start position in the carriage moving direction is corrected by software.	A first dot adjustment pattern is printed. Examine the lines printed near the left edge of the printout and enter the value for the line that is exactly 5 mm away from the left edge.	• Adjustment Program • Ruler
Head angular adjustment	This must be carried out after replacing the Printhead in order to correct tilt of the Printhead by software.	A head angular adjustment pattern is printed. Examine the printed lines and enter the value for the most straight lines.	• Adjustment Program
Bi-D adjustment	This corrects print start timing in bi-directional printing to improve the print quality.	A Bi-D adjustment pattern is printed. Black and color patterns are printed for each of the five dot sizes (ECO, VSD1, VSD2, VSD3, VSD4). So, there are 10 groups. Examine the patterns and enter the value for the pattern with no gap and overlap for each mode.	• Adjustment Program
Initialize PF deterioration offset	This resets the counter to maintain paper feed accuracy which decreases due to paper dust.	Reset the counter to its default.	• Adjustment Program
Disable PF deterioration offset	When reading the counter value from the old main board is impossible in the case of replacing the board, use this to set the counter to its maximum value.	Set the counter to its maximum value (10000).	• Adjustment Program
CR motor heat protection control	This must be carried out for efficient heat control of the CR motor. Electrical variation of the motor and the power supply board are measured to acquire correction values for them.	Select the parts that you replaced. The correction values are automatically written to the main board.	• Adjustment Program

**Table 5-1. Adjustment Items**

Adjustment Item	Purpose	Method Outline	Tool
PF motor heat protection control	This must be carried out for efficient heat control of the PF motor. Electrical variation of the motor and the power supply board are measured to acquire correction values for them.	Select the parts that you replaced. The correction values are automatically written to the main board.	• Adjustment Program
PF adjustment	This corrects variations in paper feed accuracy when using the Microweave to achieve higher print quality.	A PF adjustment pattern is printed. Examine the printout patterns and enter the value for the best pattern to register the correction value to the printer. (Carry out the procedure for each color.)	• Adjustment Program
PF band adjustment	This corrects variations in paper feed accuracy in the band print mode to achieve higher print quality.	A PF band adjustment pattern is printed. Examine the printout patterns and enter the value for the best pattern to register the correction value to the printer.	• Adjustment Program
Bottom margin adjustment	In order to improve the throughput, the printer minimizes the number of print passes when printing on the bottom margin (bleed) in the borderless printing. This may cause white area to appear on the bottom edge of the borderless printout. In such case, use this adjustment to correct the printing range on the bottom margin (bleed).	A bottom margin adjustment pattern is printed. Examine the printout patterns and enter the value for best pattern to register the correction value to the printer.	• Adjustment Program • Ruler

**Table 5-2. Maintenance Items**

Maintenance Item	Purpose	Method Outline	Tool
Waste ink pad counter	The printer causes a maintenance error when the waste ink pad counter reaches its maximum. Use this to reset the counter after replacing the Waste Ink Pad. If you find the counter is close to the maximum during servicing, carry out the pad replacement and the counter reset to avoid the printer returned from the user due to the maintenance error.	After replacing the Waste Ink Pad, reset the counter to its default.	• Adjustment Program
Ink charge	This must be carried out after replacing the Printhead in order to fill ink inside the new Printhead. The Printhead becomes ready for print.	Filling ink inside the Printhead is automatically performed. Print a nozzle check pattern to check if all nozzles are firing ink properly.	• Adjustment Program

**Table 5-3. Additional Functions**

Additional Functions		Purpose	Method Outline	Tool
Final check pattern print	A4 size	Use this to check if the all adjustments have been properly made.	The all adjustment patterns are printed automatically.	• Adjustment Program
	US Letter size			
EEPROM dump		Use this to readout the EEPROM data for analysis.	The all EEPROM data is automatically readout and stored as a file.	• Adjustment Program
Printer information check	Manual CL counter	Use this to readout information on the printer operations.	The printer information is automatically readout.	• Adjustment Program
	I/C exchange CL counter			
	Timer CL counter			
	Print path counter			

### 5.1.2 Required Adjustments

The table below lists the required adjustments depending upon the parts being repaired or replaced. Find the part(s) you removed or replaced, and check which adjustment(s) must be carried out.

**Table 5-4. Required Adjustment List**

Priority		1	2	3	4	5	6	7	8	9	10	11	12	13	14	15	16
Part Name	Adjustment Item	EEPROM data copy	Initial setting	USB ID input	Waste ink pad counter	Ink charge	Head ID input	Top margin adjustment	First dot position adjustment	Head angular adjustment	BI-D adjustment	Initialize PF deterioration offset/ Disable PF deterioration offset	CR motor heat protection control	PF motor heat protection control	PF adjustment	PF band adjustment	Bottom margin adjustment
	Main board unit	Remove	---	---	---	---	---	---	---	---	---	---	---	---	---	---	---
Replace (Read OK)		O	---	---	---	---	---	---	---	---	---	---	---	---	---	---	---
Replace (Read NG)		---	O	O	O Replace the pad	---	O	O	O	O	O	O Input max. value (10000)	O	O	O	O	O
Printhead	Remove	---	---	---	---	---	---	O	O	O	O	---	---	---	O	O	O
	Replace	---	---	---	---	O	O	O	O	O	O	---	---	---	O	O	O
Power Supply unit	Remove	---	---	---	---	---	---	---	---	---	---	---	---	---	---	---	---
	Replace	---	---	---	---	---	---	---	---	---	---	---	O	O	---	---	---
Hopper	Remove	---	---	---	---	---	---	O	O	---	---	---	---	---	---	---	---
	Replace	---	---	---	---	---	---	O	O	---	---	---	---	---	---	---	---
CR motor	Remove	---	---	---	---	---	---	---	---	---	---	---	---	---	---	---	---
	Replace	---	---	---	---	---	---	---	---	---	---	---	O	---	---	---	---
EJ roller	Remove	---	---	---	---	---	---	---	---	---	O	---	---	---	O	O	O
	Replace	---	---	---	---	---	---	---	---	---	O	---	---	---	O	O	O
PF motor	Remove	---	---	---	---	---	---	---	---	---	---	---	---	---	---	---	---
	Replace	---	---	---	---	---	---	---	---	---	---	---	---	O	---	---	---
Main frame	Remove	---	---	---	---	---	---	---	---	O	O	---	---	---	---	---	---
	Replace	---	---	---	---	---	---	---	---	O	O	---	O	---	---	---	---



Table 5-4. Required Adjustment List

Priority		1	2	3	4	5	6	7	8	9	10	11	12	13	14	15	16
Adjustment Item	Part Name	EPPROM data copy	Initial setting	USB ID input	Waste ink pad counter	Ink charge	Head ID input	Top margin adjustment	First dot position adjustment	Head angular adjustment	Bi-D adjustment	Initialize PF deterioration offset/ Disable PF deterioration offset	CR motor heat protection control	PF motor heat protection control	PF adjustment	PF band adjustment	Bottom margin adjustment
		ASF unit	Remove	---	---	---	---	---	---	O	O	---	---	---	---	---	O
	Replace	---	---	---	---	---	---	O	O	---	---	---	---	---	O	O	O
CR unit	Remove	---	---	---	---	---	---	O	O	O	O	---	---	---	O	O	O
	Replace	---	---	---	---	---	---	O	O	O	O	---	---	---	O	O	O
Upper paper guide	Remove	---	---	---	---	---	---	O	---	---	---	---	---	---	O	O	O
	Replace	---	---	---	---	---	---	O	---	---	---	O Reset to 0	---	---	O	O	O
Front paper guide unit	Remove	---	---	---	---	---	---	O*	---	O	O	---	---	---	O	O	O
	Replace	---	---	---	---	---	---	O*	---	O	O	---	---	---	O	O	O
PF roller	Remove	---	---	---	---	---	---	O*	---	---	---	---	---	---	O	O	O
	Replace	---	---	---	---	---	---	O*	---	---	---	---	---	---	O	O	O
Waste ink pad	Remove	---	---	---	---	---	---	---	---	---	---	---	---	---	---	---	---
	Replace	---	---	---	O	---	---	---	---	---	---	---	---	---	---	---	---



- When the EEPROM data copy is impossible with the main board that needs to be replaced, the Waste Ink Pad must be replaced after replacing the main board with a new one.
- After all required adjustments are completed, use the “Final check pattern print” function to print all adjustment patterns for final check. If you find a problem with the printout patterns, carry out the adjustment again.
- When using a new main board for replacing the Printer Mechanism, the Initial setting must have been made to the main board.

<Meaning of the marks in the table>

“O” indicates that the adjustment must be carried out. “O\*” indicates that the adjustment is recommended. “---” indicates that the adjustment is not required.

If you have removed or replaced multiple parts, make sure to check the required adjustments for the all parts. And when multiple adjustments must be carried out, be sure to carry out them in the order given in the “Priority” row.

## 5.2 Using the Adjustment Program

This section describes how to judge the adjustment patterns printed by the Adjustment Program. For information on how to operate the Adjustment Program, see the instructions displayed by the Adjustment Program.

### 5.2.1 TOP Margin Adjustment

The following pattern is printed.

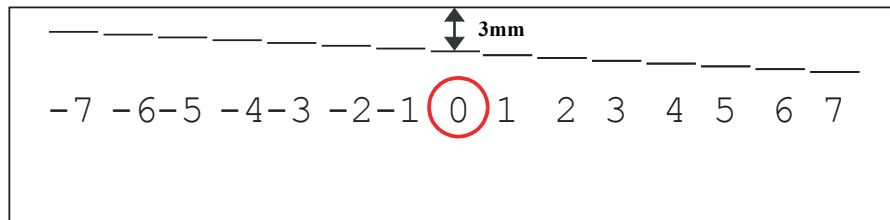


Figure 5-1. Top Margin Adjustment Printout Pattern

#### How to Judge

Measure the length from the top edge of the paper to the printed line. Enter the value for the line that is exactly 3 mm away from the top edge.

### 5.2.2 First Dot Position Adjustment

The following pattern is printed.

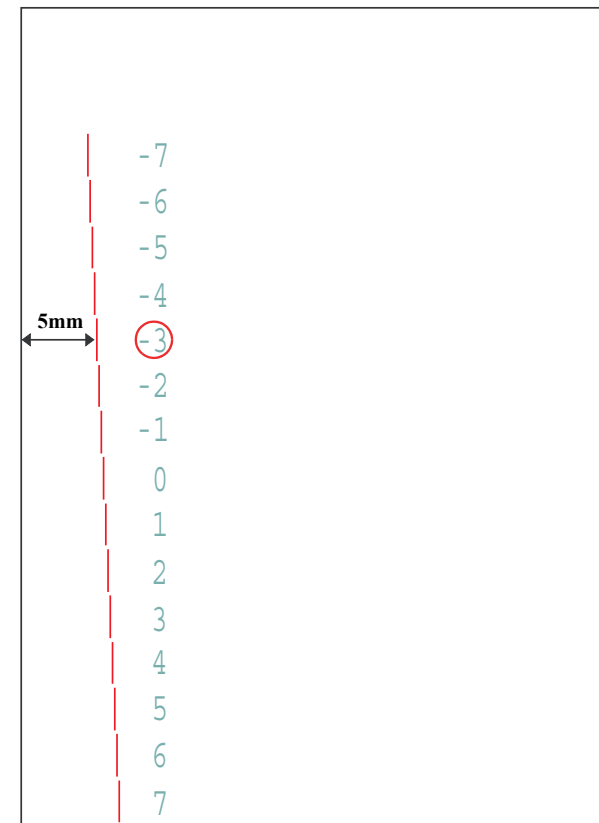


Figure 5-2. First Dot Position Adjustment Printout Pattern

#### How to judge

Measure the length from the left edge of the paper to the printed line. Enter the value for the line that is exactly 5 mm away from the left edge.

### 5.2.3 Head Angular Adjustment

Two patterns are printed as shown below.

Band pattern

The following pattern is printed. The lines below “1 to 80” are printed while the carriage moves from the home to the other side, and lines below “80 to 1” are printed while the carriage returns to the home.

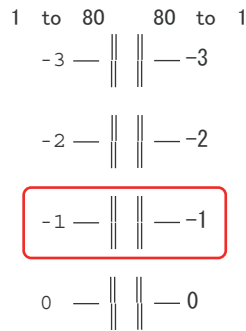


Figure 5-3. Head Angular Adjustment Printout Pattern (1)

**How to Judge**

Examine the printout patterns and enter the value (-3 to 3) for the most straight lines.

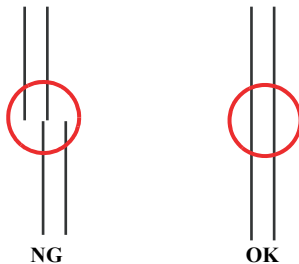
**Additional information**

When “3” or “-3” is the most straight lines, it indicates that the Printhead is not installed correctly. Reassemble the Printhead and carry out this adjustment again.

CHECK POINT



Example for judgement



Microweave Pattern

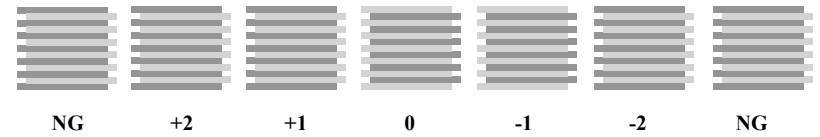


Figure 5-4. Head angular adjustment Pattern Printing (2)

**How to Judge**

Examine the printout patterns (+2 to -2) and select the value for the group of which the gaps between the 2 color bars are the smallest.

**Additional information**

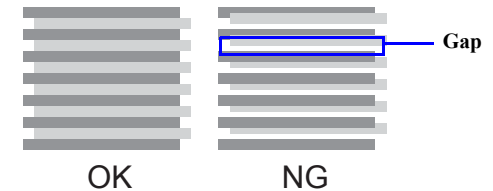
If no appropriate pattern is found, reassemble/replace the Printhead.

When “+2” or “-2” is the group of which the gaps between the 2 color bars are the smallest, reassemble/replace the Printhead.

CHECK POINT



Example for judgement



## 5.2.4 Bi-D Adjustment

The following pattern is printed for each of the five print mode (five dot size modes).



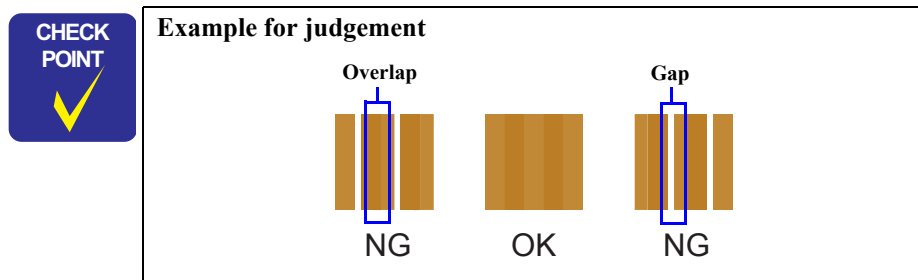
Figure 5-5. Bi-D Adjustment Printout Pattern

### How to Judge

Examine the printout patterns for each of the five modes, and enter the value for the pattern with no gap and overlap for each mode.

### Additional Information

If no OK pattern is printed, enter the value for the best one, and print the adjustment pattern again.



## 5.2.5 PF Adjustment

### □ PF- for standard print area

The following pattern is printed.

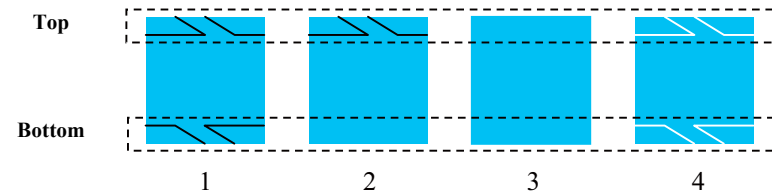


Figure 5-6. PF (standard print area) Adjustment Printout Pattern

### How to Judge

1. Examine the printed patches from the left to the right, and select a value for the patch with least white oblique lines on its upper (top) area. If two or more patches are found as the best patch, be sure to select a value for the left most one.

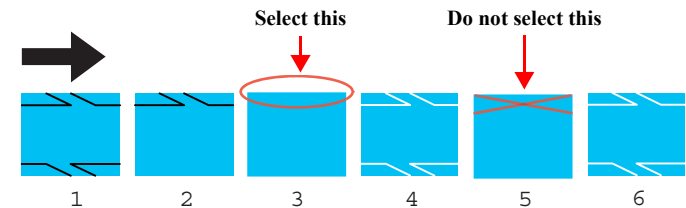


Figure 5-7. PF Adjustment (1)

2. Examine the printed patches from the right to the left, and select a value for the patch with least white lines on its lower (bottom) area. If two or more patches are found as the best patch, be sure to select a value for the right most one. If it is difficult to judge, compare the most likely patch with the one on the left.

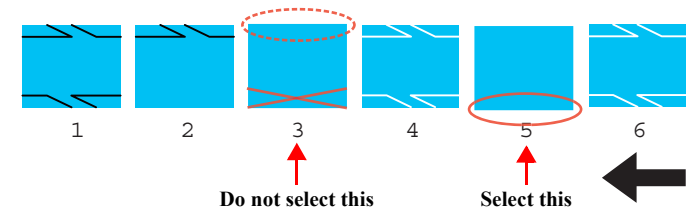
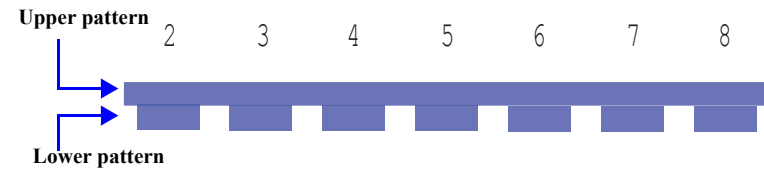


Figure 5-8. PF Adjustment (2)

- Input the selected value for each of the top and bottom in the program, and print a PF adjustment check pattern.

PF- for bottom margin area

The following pattern is printed.



**Figure 5-9. PF (bottom margin area) Adjustment Printout Pattern**

**How to Judge**

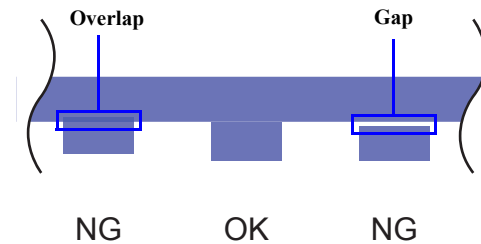
Examine the printout patterns, and enter the value for the pattern with no overlap and gap between the upper and lower ones.

**Additional Information**

When overlap and gap are observed in the all patterns, enter the value for the best one, and print the adjustment pattern again.



**Example for judgement**



## 5.2.6 PF Band Adjustment

The following pattern is printed.



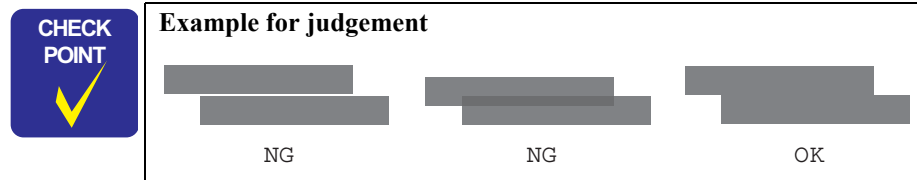
Figure 5-10. PF Band Adjustment Printout Pattern

### How to Judge

Examine the printout patterns and enter the value for the pattern with no overlap and gap between the two rectangles.

### Additional Information

When overlap and gap are observed in the all patterns, enter the value for the best one, and print the adjustment pattern again.



## 5.2.7 Bottom Margin Adjustment

The following pattern is printed.

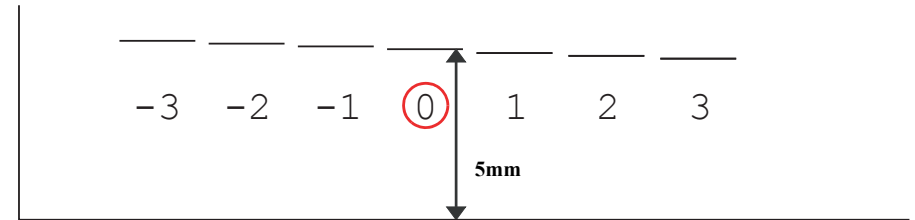


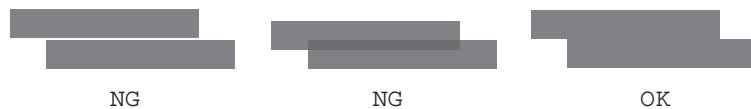
Figure 5-11. Bottom Margin Adjustment Printout Pattern

### How to Judge

Measure the length from the bottom edge of the paper to the printed line. Enter the value for the line that is exactly 5 mm away from the bottom edge.



### Example for judgement



**CHAPTER**

**6**

**MAINTENANCE**

## 6.1 Overview

This section provides information to maintain the printer in its optimum condition.

### 6.1.1 Cleaning

This printer has no mechanical components which require regular cleaning except the Printhead. Therefore, when returning the printer to the user, check the following parts and perform appropriate cleaning if stain is noticeable.

**CAUTION**



- Never use chemical solvents, such as thinner, benzine, and acetone to clean the exterior parts of the printer like the Housing. These chemicals may deform or deteriorate the components of the printer.
- Be careful not to damage any components when you clean inside the printer.
- Do not scratch the coated surface of the PF roller. Use a soft brush to wipe off any dusts.
- Use a soft cloth moistened with alcohol to remove the ink stain.
- When using compressed air products; such as air duster, for cleaning during repair and maintenance, the use of such products containing flammable gas is prohibited.

- Exterior parts  
Use a clean soft cloth moistened with water, and wipe off any dirt. If the exterior parts are stained by the ink, use a cloth moistened with neutral detergent to wipe it off.
- Inside the printer  
Use a vacuum cleaner to remove any paper dust.
- LD Roller  
When paper loading function does not operate because friction of the LD roller is lowered by any paper dust, use a soft cloth moistened with alcohol to remove the paper dust.

### 6.1.2 Service Maintenance

If any abnormal print (dot missing, white line, etc.) has occurred or the printer indicates the “Maintenance request error” (This error is displayed as “Service Required” in the STM3), take the following actions to clear the error.

#### 6.1.2.1 Printhead cleaning

When dot missing or banding phenomenon has occurred, you need to perform the Printhead cleaning operation\* by using the Printhead cleaning function. This function can be performed by the control panel operation, the printer driver utility and the Adjustment program.

\* : EPSON Stylus CX7300/CX7400/DX7400/NX200/TX200/TX203/TX209/SX200/SX205 and Stylus CX8300/CX8400/DX8400/NX400/TX400/TX405/TX409/SX400/SX405 have three modes for manual cleaning, and even during printing, the appropriate cleaning mode is automatically selected and performed according to various conditions. Therefore the ink consumption amount for manual cleaning varies depending on each mode.

#### 6.1.2.2 Maintenance request error

Ink is used for the Printhead cleaning or cap flushing operation as well as the printing operation. When the ink is used for the Printhead cleaning or flushing operation, the ink is drained via the pump to the Waste ink pads. The amount of the waste ink is stored as the waste ink counter into the EEPROM on the Main Board. Due to this, when the waste ink counter has reached the limit of the absorbing capability of the Waste ink pads, the Maintenance call error is indicated on Status monitor 3. However, the limit value of the waste ink counter varies according to the usage.

**CHECK POINT**



**Refer to following chapter about indication of the maintenance request error.**

- **Chapter 3 TROUBLESHOOTING (p.58)**

When the maintenance request error has occurred, replace the waste ink pad with new one and clear the waste ink counter stored into the EEPROM. If the waste ink counter is closed to its limit, we recommend to replace the Waste ink pad with new one. This is because the Maintenance request error will may occur after returning the repaired product to the customer.



### 6.1.3 Lubrication

The type and amount of the grease used to lubricate the printer parts are determined based on the results of the internal evaluations. Therefore, be sure to apply the specified type and amount of the grease to the specified part of the printer mechanism on the following occasion.

- Any parts required the lubrication are replaced.
- The printer is disassembled/assembled. (If necessary)



- Never use oil or grease other than those specified in this manual. Use of different types of oil or grease may damage the component or give bad influence on the printer function.
- Never apply larger amount of grease than specified in this manual.

Table 6-1. Specified Lubricant

Type	Name	EPSON Code	Supplier
Grease	G-45	1033657	EPSON
Grease	G-71	1304682	EPSON
Grease	G-74	1409257	EPSON

- Refer to the following figures for the lubrication points.

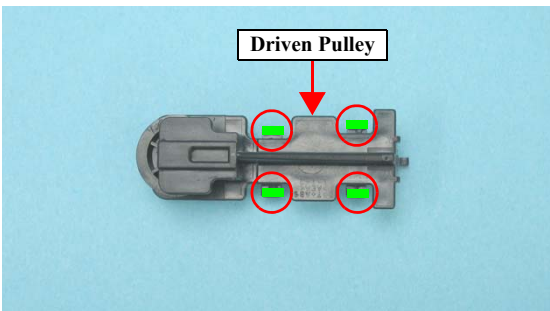
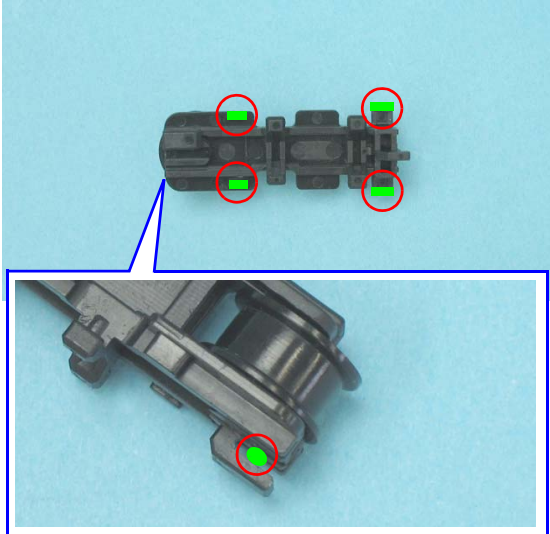
<div style="border: 1px solid black; padding: 2px; margin-bottom: 5px; text-align: center;">Front</div> 	<p>&lt;Lubrication Point&gt; Contact points (x 9) with the Main Frame.</p>
<div style="border: 1px solid black; padding: 2px; margin-bottom: 5px; text-align: center;">Back</div> 	<p>&lt;Lubrication Type&gt; G-71</p>
<p>&lt;Lubrication Amount&gt; φ 1 mm x 1 mm</p>	
<p>&lt;Remarks&gt; Use an injector to apply G-71.</p>	

Figure 6-1. Lubrication on Driven Pulley

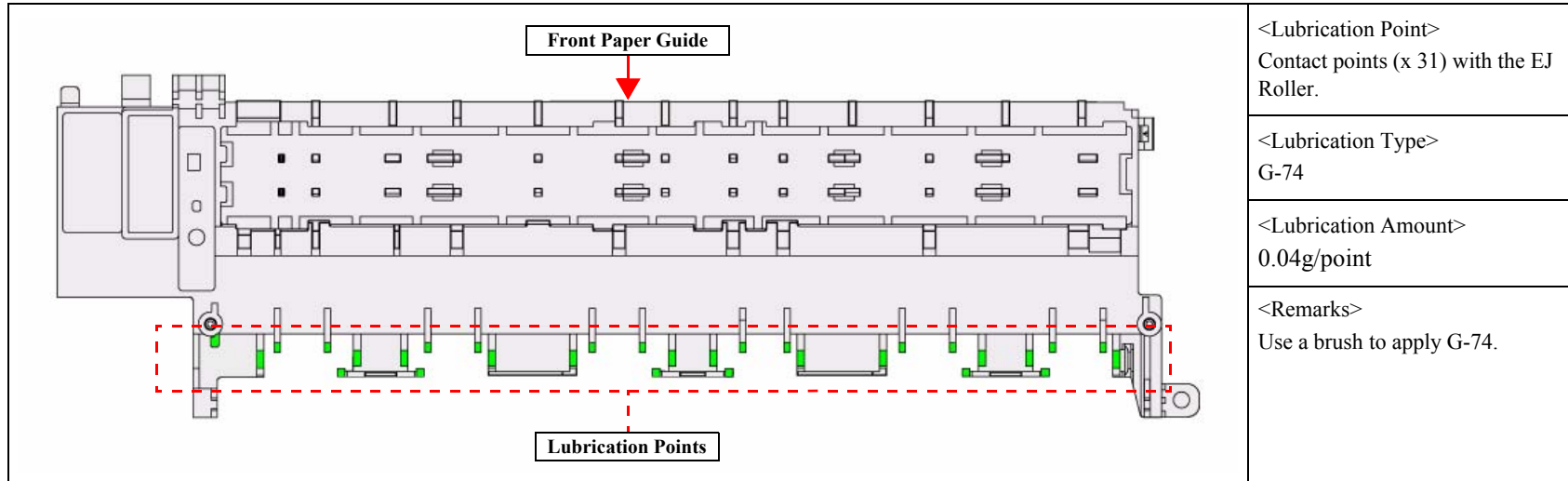


Figure 6-2. Lubrication on Front Paper Guide (1)

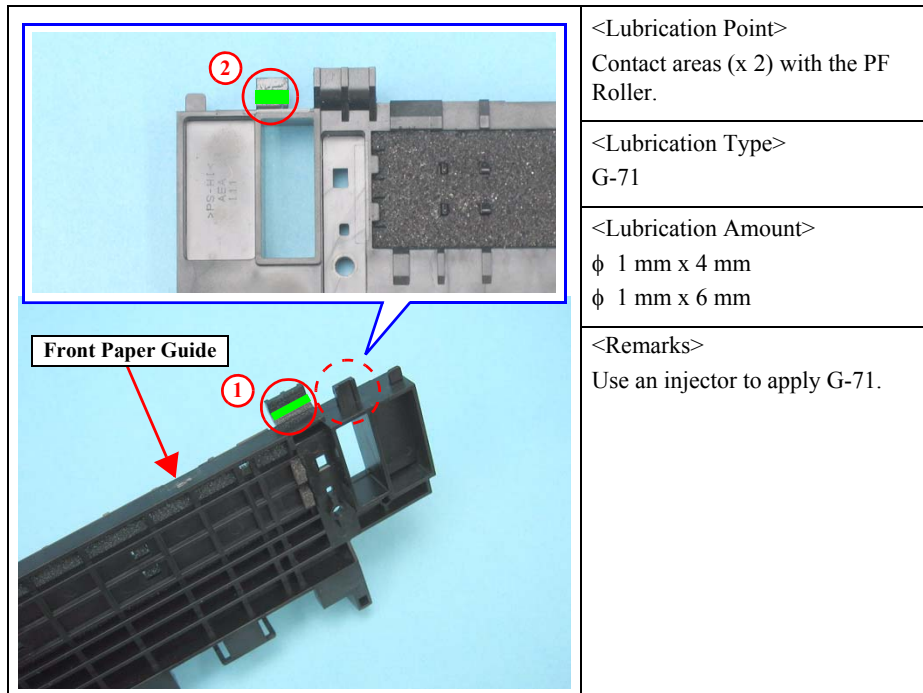


Figure 6-3. Lubrication on Front Paper Guide (2)

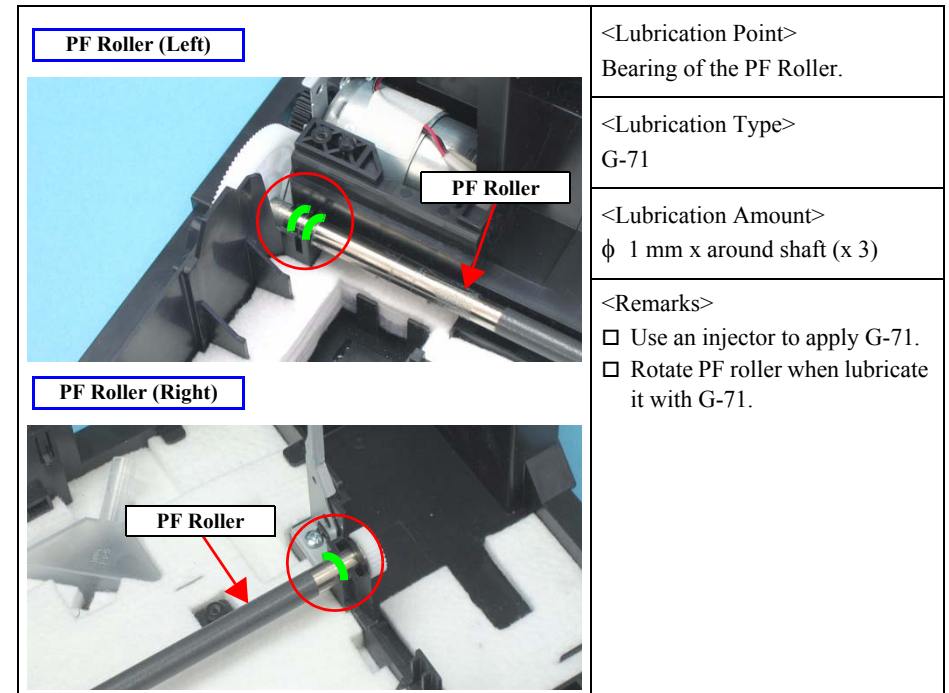


Figure 6-4. Lubrication on PF Roller

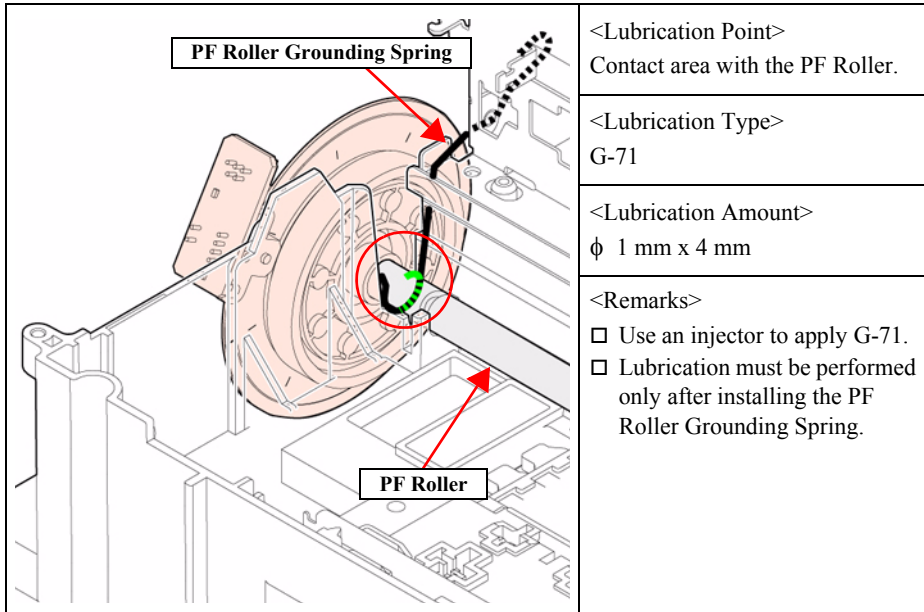


Figure 6-5. Lubrication on PF Roller Grounding Spring

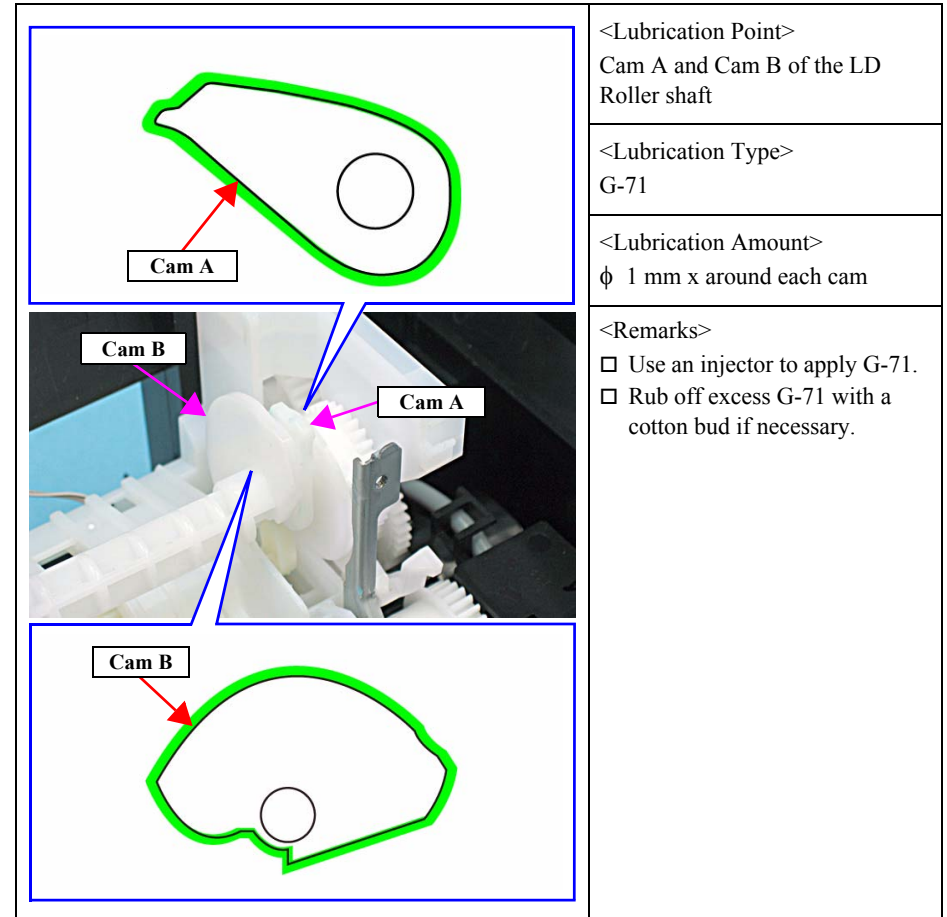


Figure 6-6. Lubrication on LD Roller Shaft

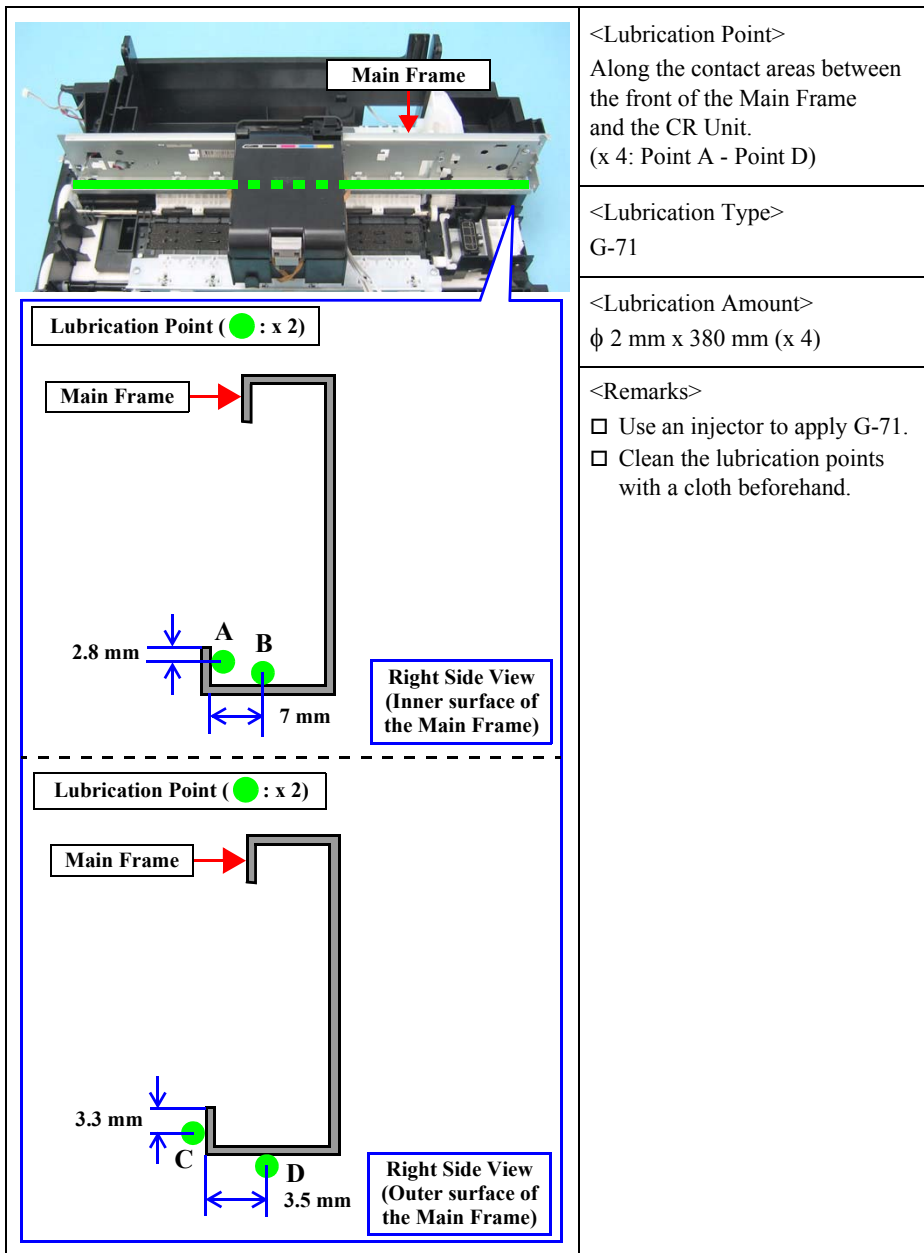


Figure 6-7. Lubrication on Main Frame (1)

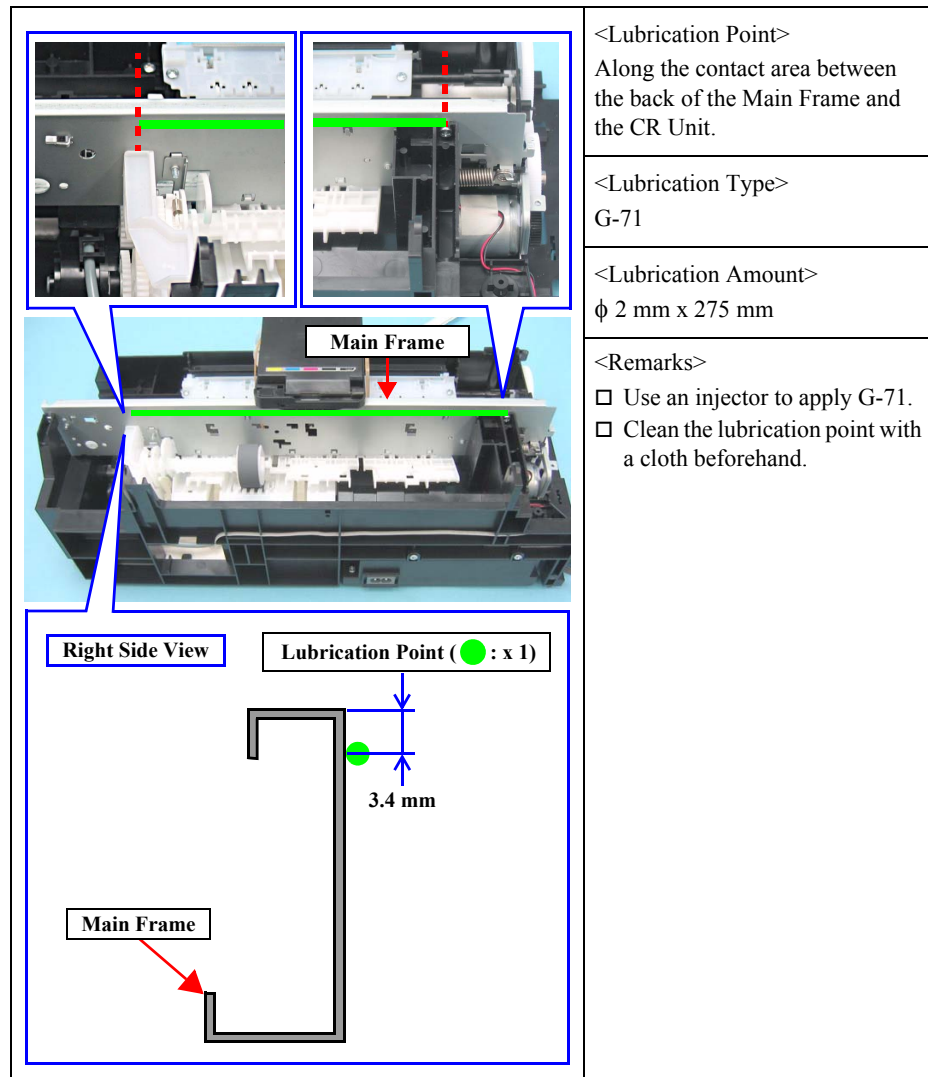


Figure 6-8. Lubrication on Main Frame (2)

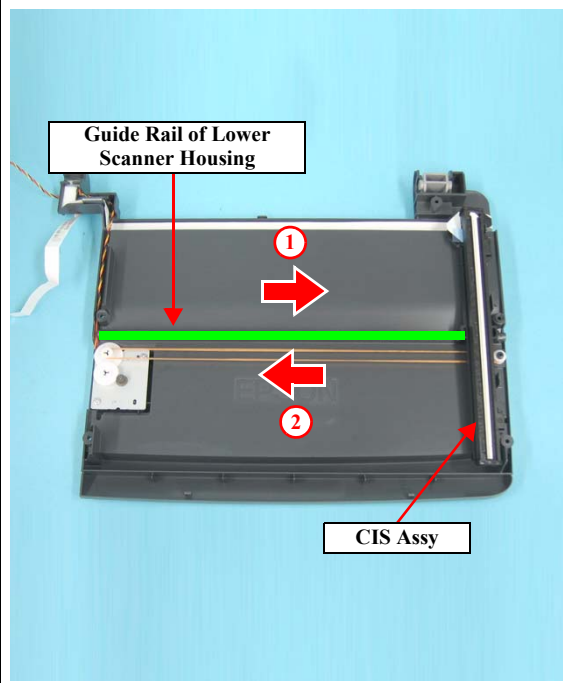
	<p>&lt;Lubrication Point&gt; On the surface of the Guide Rail of the Lower Scanner Housing.</p>
	<p>&lt;Lubrication Type&gt; G-45</p>
	<p>&lt;Lubrication Amount&gt; Sufficient quantity</p>
	<p>&lt;Remarks&gt;</p> <ul style="list-style-type: none"> <li><input type="checkbox"/> Use a brush to apply G-45.</li> <li><input type="checkbox"/> Follow the procedures below.</li> <li>1. Move the CIS Assy to the right and apply grease on the rail.</li> <li>2. Move the CIS Assy to the left and apply grease on the rail.</li> <li>3. If the CIS Assy is contaminated with grease, wipe off the grease with a cloth.</li> </ul>

Figure 6-9. Lubrication on the Guide Rail of the Lower Scanner Housing

**CHAPTER**

**7**

**APPENDIX**

## **7.1 Exploded Diagram / Parts List**

---

This manual does not provide exploded diagrams or parts list.  
For the information, see SPI (Service Parts Information).